

Transmission

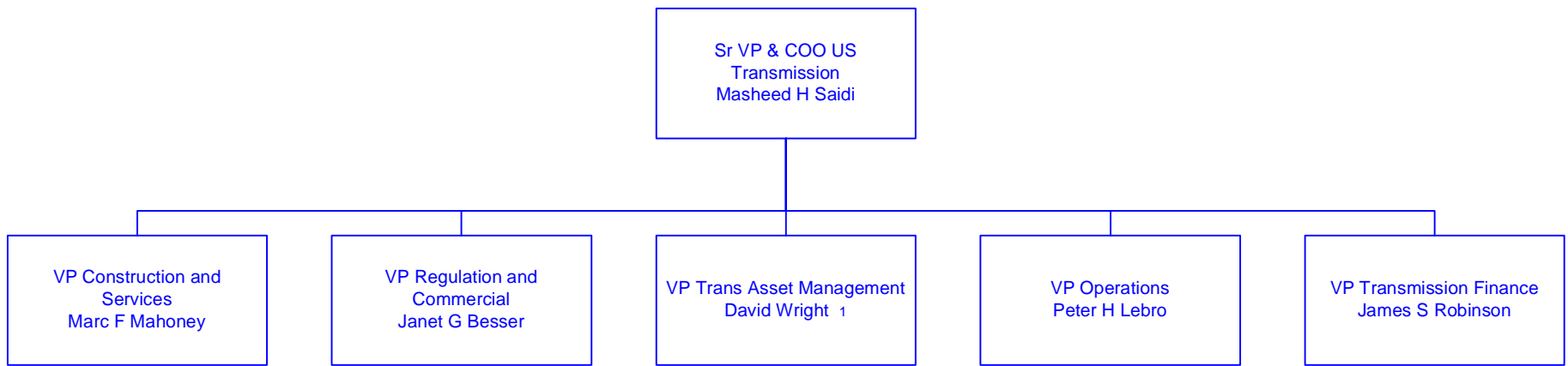

All employees shown on this page are employed by National Grid USA Service Co.
Information shown in blue represents a Transmission Function

Last Updated 11/01/06

Transmission Construction and Services

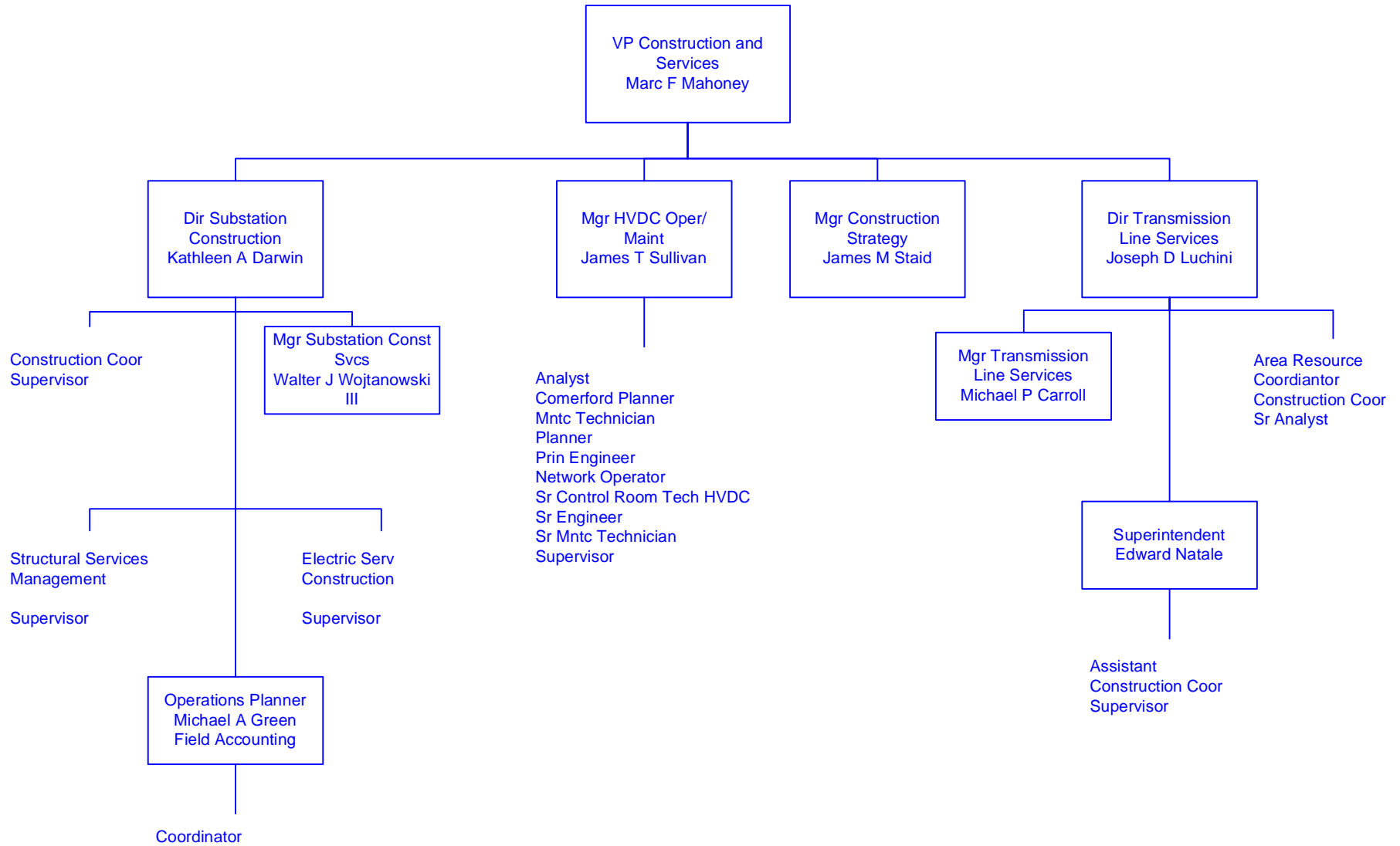

All employees shown on this page are employed by National Grid USA Service Co.
Information shown in blue represents a Transmission Function

Last Updated 01/16/07

Transmission Regulation and Commercial

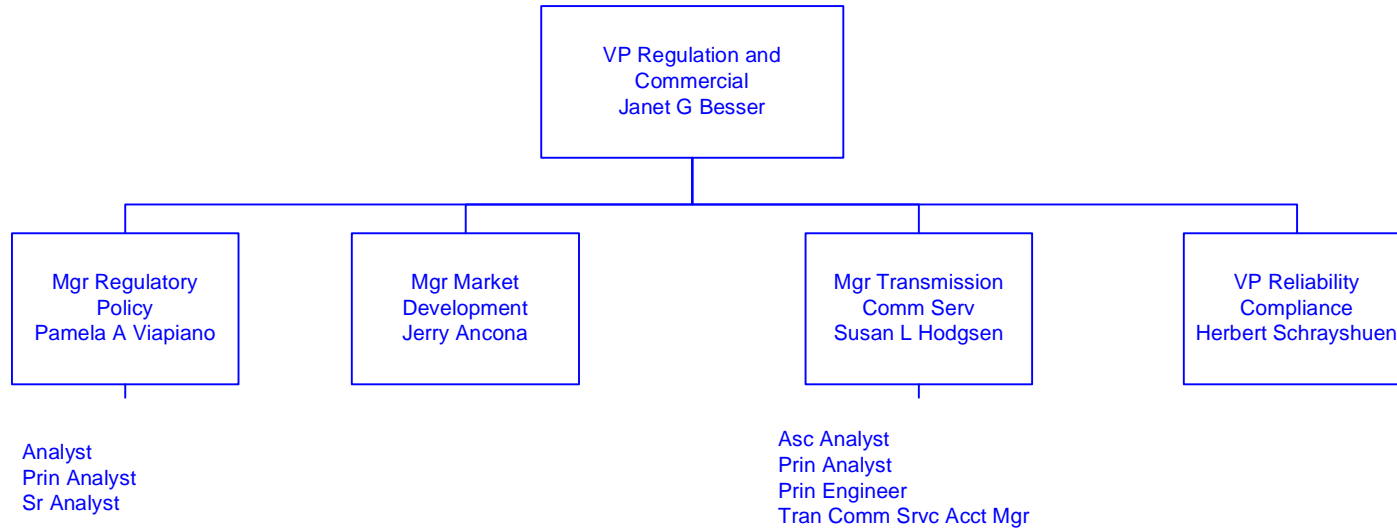

All employees shown on this page are employed by National Grid USA Service Co.
Information shown in blue represents a Transmission Function

Last Updated 12/11/06

Transmission Network Operations

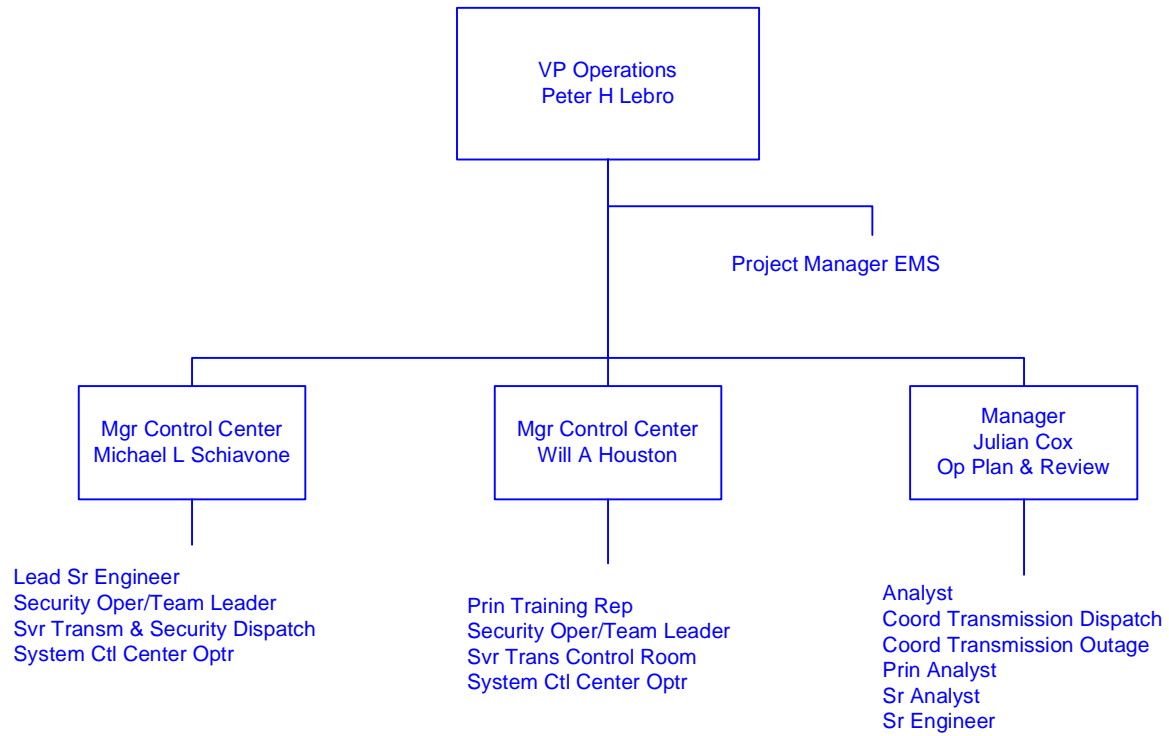

All employees shown on this page are employed by National Grid USA Service Co.
Information shown in blue represents a Transmission Function

Last Updated 12/11/06

Transmission Finance

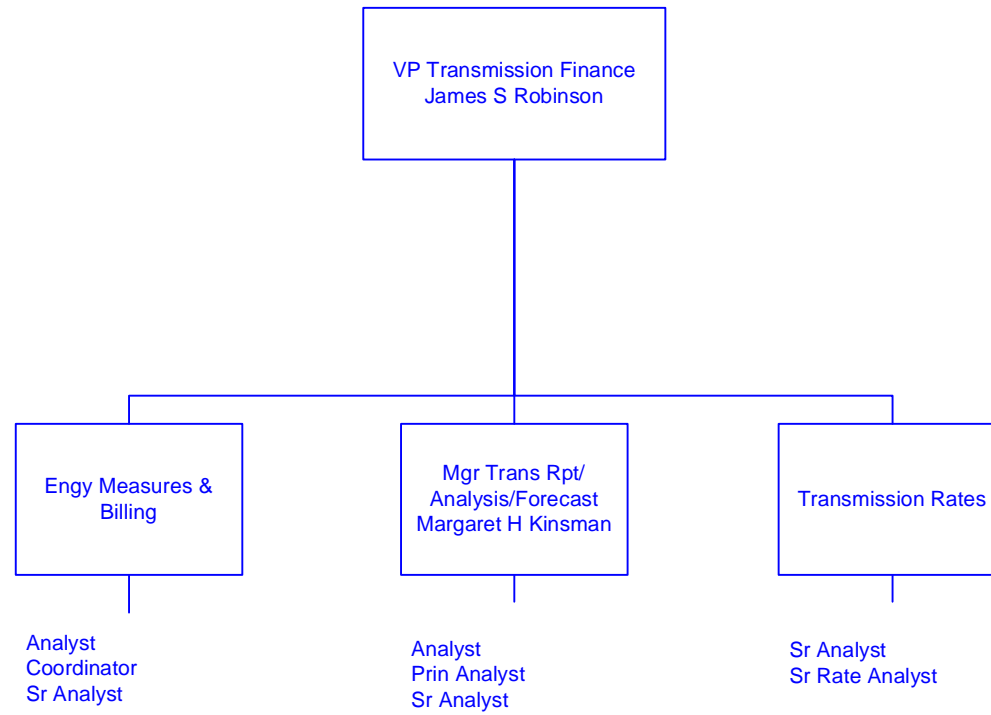

All employees shown on this page are employed by National Grid USA Service Co.
Information shown in blue represents a Transmission Function

Last Updated 02/05/07

Transmission Asset Management

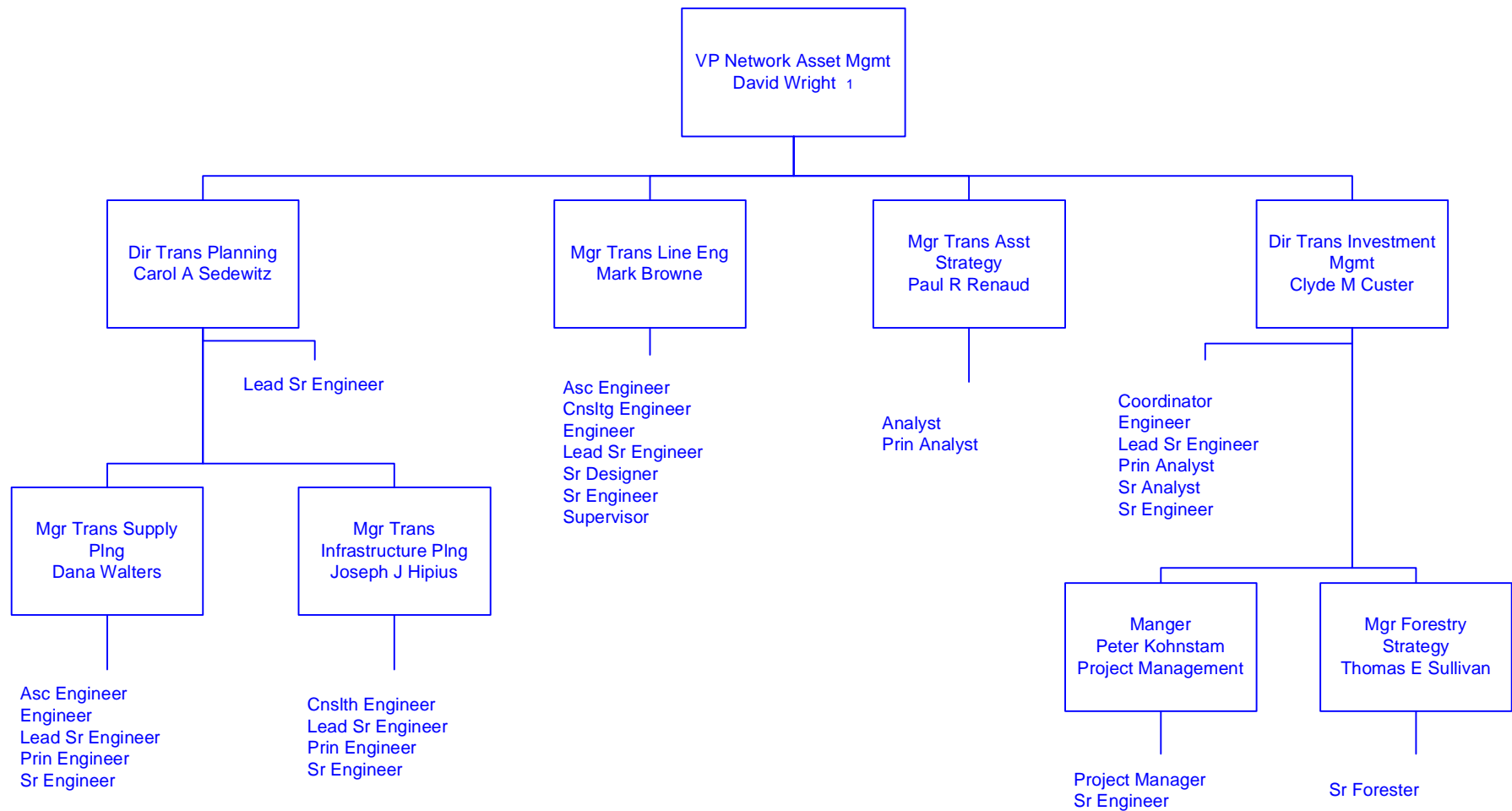

All employees shown on this page are employed by National Grid USA Service Co.
Information shown in blue represents a Transmission Function

Last Updated 11/01/06

National Grid USA

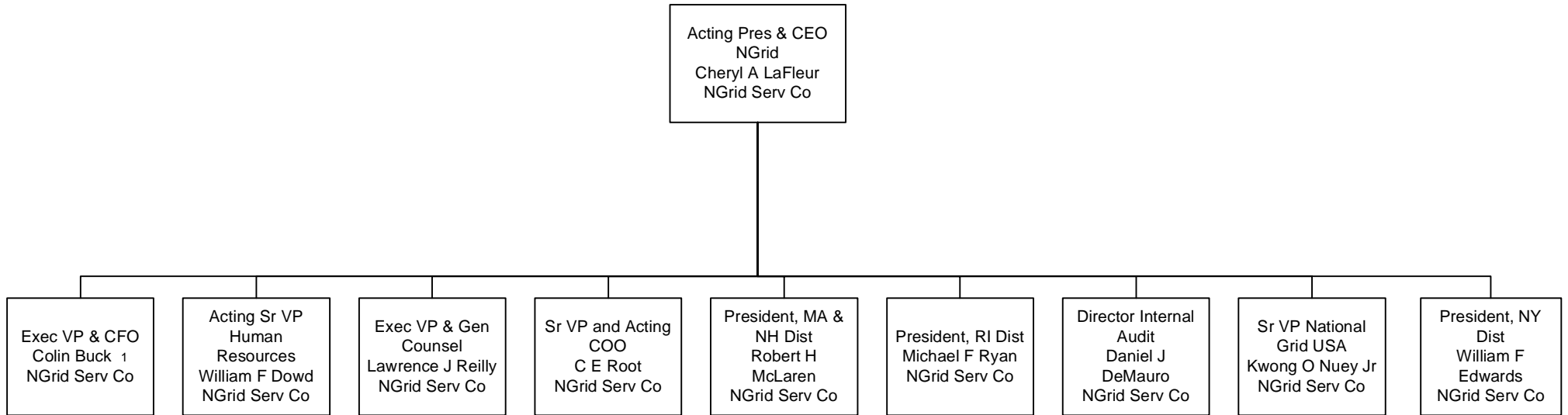

GECS = Granite State Electric Company
 MECO = Massachusetts Electric Company
 Nant = Nantucket Electric Company
 NECO = The Narragansett Electric Company
 NECO Gas = Narragansett Electric Company
 NGrid Serv Co = National Grid USA Service Company Inc
 NIMO = Niagara Mohawk Power Corporation
 Information shown in Blue represents a Transmission Function
 Information shown in Red represents a Sales & Marketing Function

Business Service MA and NH

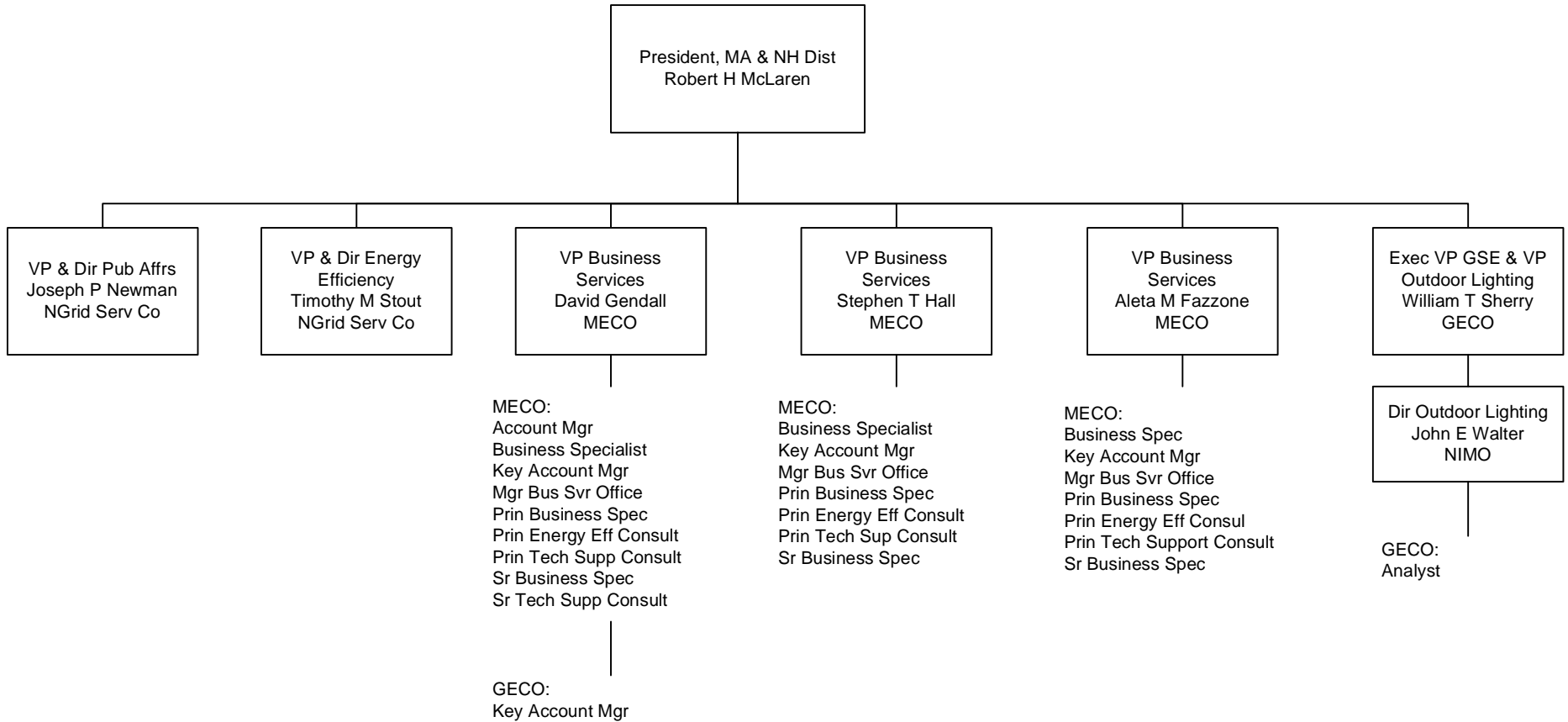

GECO = Granite State Electric Company
 MECO = Massachusetts Electric Company
 Nant = Nantucket Electric Company
 NECO = The Narragansett Electric Company
 NECO Gas = Narragansett Electric Company
 NGrid Serv Co = National Grid USA Service Company Inc
 NIMO = Niagara Mohawk Power Corporation
 Information shown in Blue represents a Transmission Function
 Information shown in Red represents a Sales & Marketing Function

Business Service RI

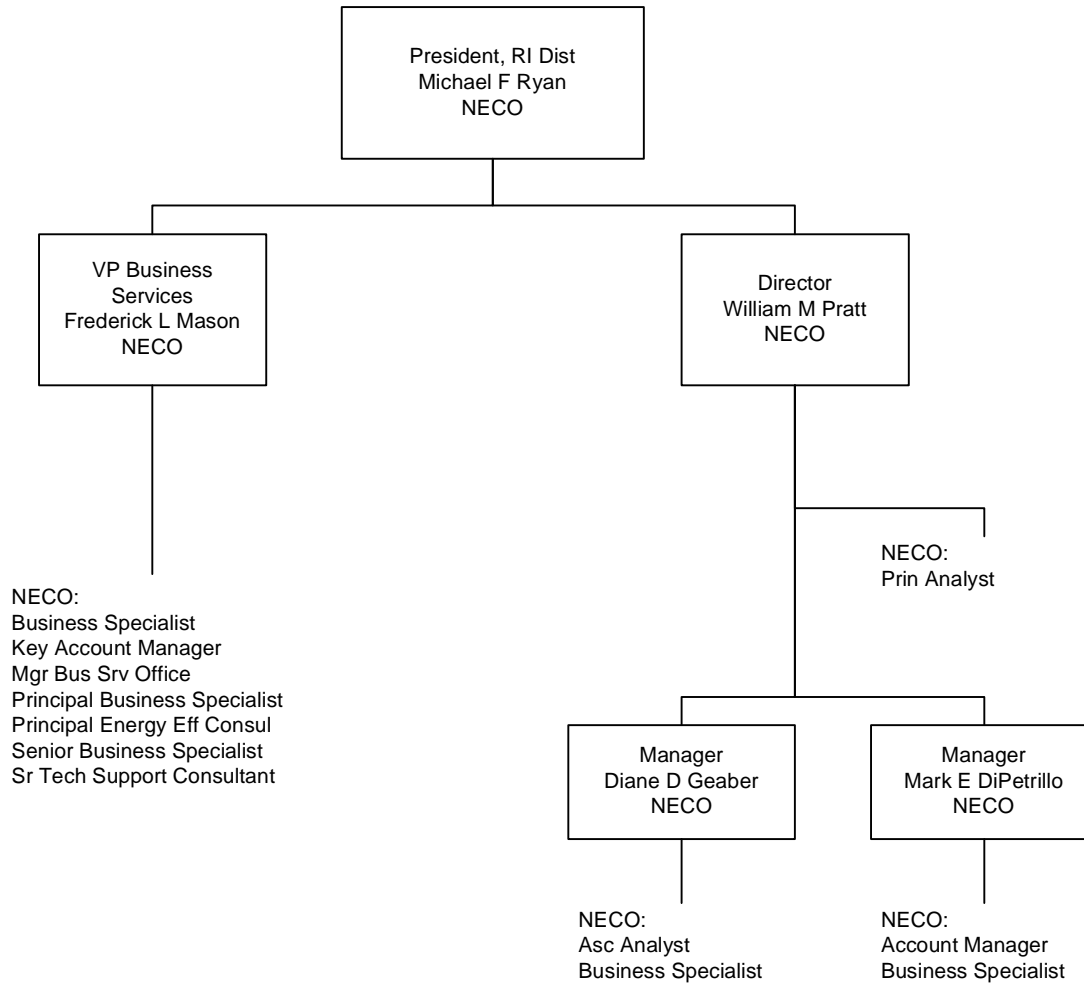

GECO = Granite State Electric Company
 MECO = Massachusetts Electric Company
 Nant = Nantucket Electric Company
 NECO = The Narragansett Electric Company
 NECO Gas = Narragansett Electric Company
 NGrid Serv Co = National Grid USA Service Company Inc
 NIMO = Niagara Mohawk Power Corporation
 Information shown in Blue represents a Transmission Function
 Information shown in Red represents a Sales & Marketing Function

Operations

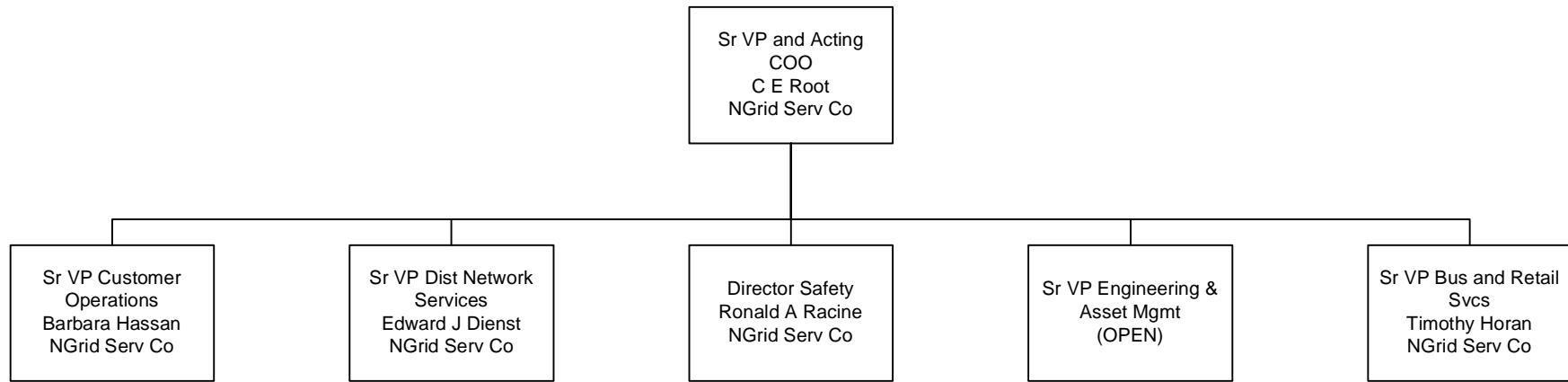

GECO = Granite State Electric Company
MECO = Massachusetts Electric Company
Nant = Nantucket Electric Company
NECO = The Narragansett Electric Company
NECO Gas = Narragansett Electric Company
NGrid Serv Co = National Grid USA Service Company Inc
NIMO = Niagara Mohawk Power Corporation
Information shown in Blue represents a Transmission Function
Information shown in Red represents a Sales & Marketing Function

Distribution Operations

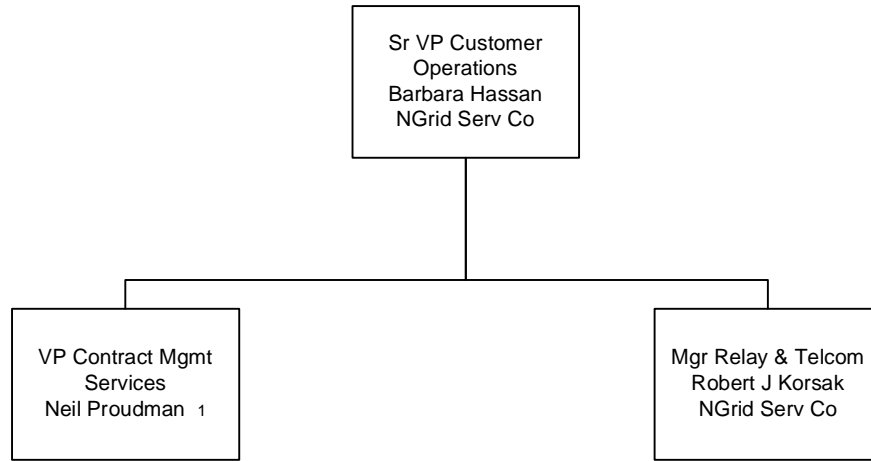

GECO = Granite State Electric Company

MECO = Massachusetts Electric Company

Nant = Nantucket Electric Company

NECO = The Narragansett Electric Company

NECO Gas = Narragansett Electric Company

NGrid Serv Co = National Grid USA Service Company Inc

NIMO = Niagara Mohawk Power Corporation

Information shown in Blue represents a Transmission Function

Information shown in Red represents a Sales & Marketing Function

Last Updated 02/13/07

Distribution Network Services

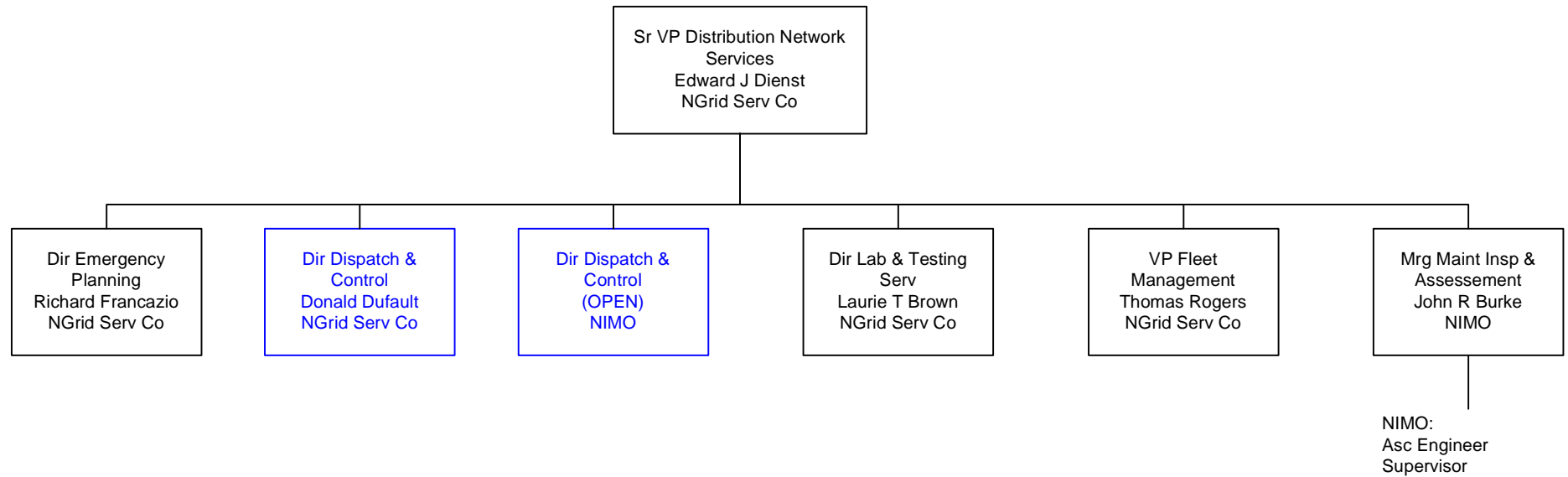

GECO = Granite State Electric Company
 MECO = Massachusetts Electric Company
 Nant = Nantucket Electric Company
 NECO = The Narragansett Electric Company
 NECO Gas = Narragansett Electric Company
 NGrid Serv Co = National Grid USA Service Company Inc
 NIMO = Niagara Mohawk Power Corporation
 Information shown in Blue represents a Transmission Function
 Information shown in Red represents a Sales & Marketing Function

New England Distribution Dispatch and Control

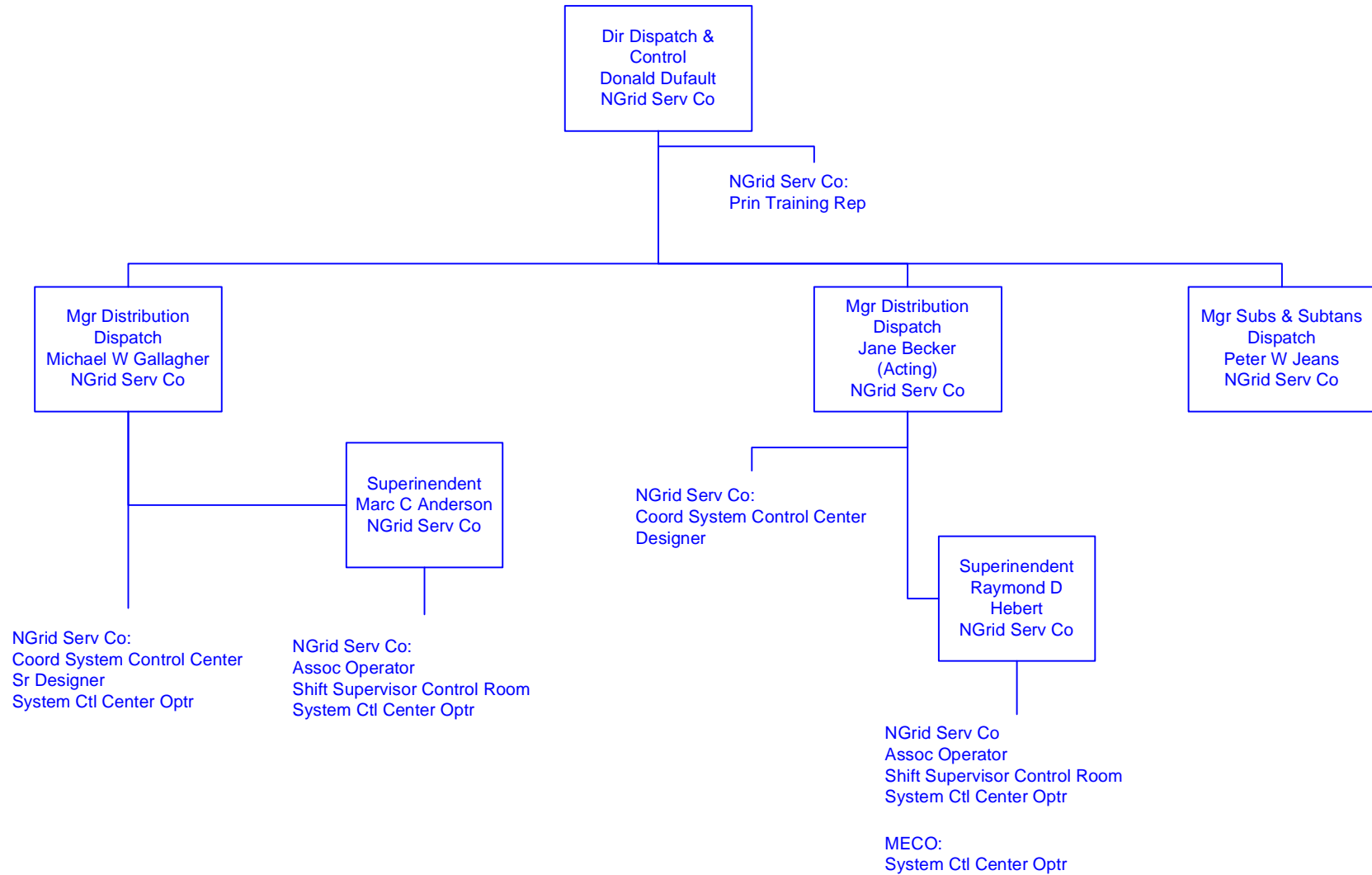

GEICO = Granite State Electric Company
 MECO = Massachusetts Electric Company
 Nant = Nantucket Electric Company
 NECO = The Narragansett Electric Company
 NECO Gas = Narragansett Electric Company
 NGrid Serv Co = National Grid USA Service Company Inc
 NIMO = Niagara Mohawk Power Corporation
 Information shown in Blue represents a Transmission Function
 Information shown in Red represents a Sales & Marketing Function

New York Distribution Dispatch and Control

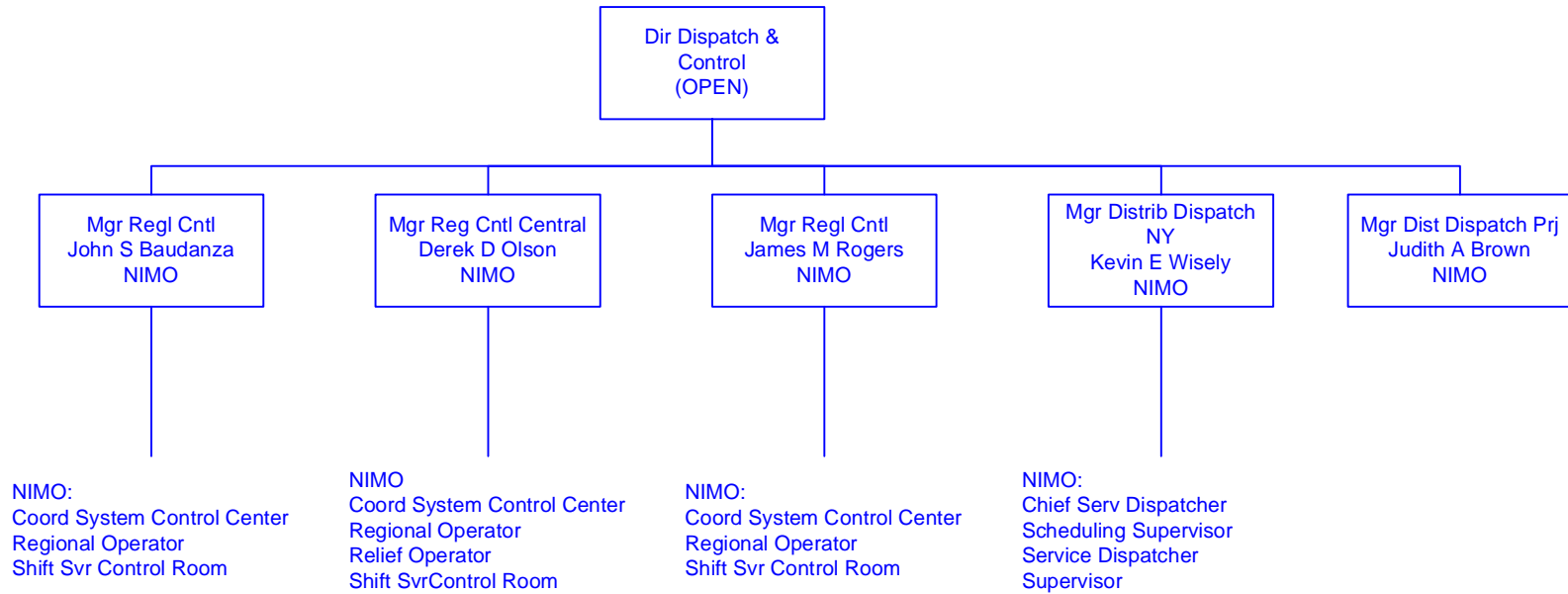

GECCO = Granite State Electric Company
 MECO = Massachusetts Electric Company
 Nant = Nantucket Electric Company
 NECO = The Narragansett Electric Company
 NECO Gas = Narragansett Electric Company
 NGrid Serv Co = National Grid USA Service Company Inc
 NIMO = Niagara Mohawk Power Corporation
 Information shown in Blue represents a Transmission Function
 Information shown in Red represents a Sales & Marketing Function

Lab and Testing Services

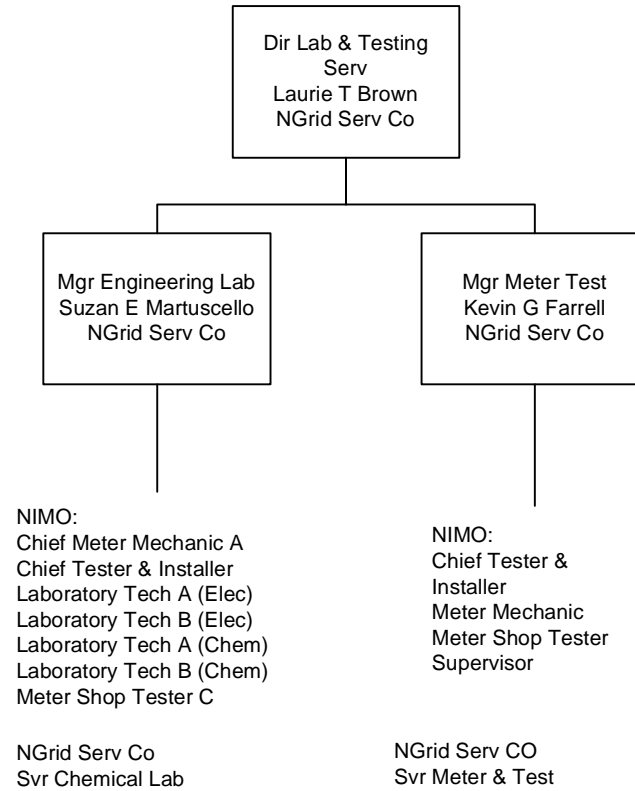

GECO = Granite State Electric Company

MECO = Massachusetts Electric Company

Nant = Nantucket Electric Company

NECO = The Narragansett Electric Company

NECO Gas = Narragansett Electric Company

NGrid Serv Co = National Grid USA Service Company Inc

NIMO = Niagara Mohawk Power Corporation

Information shown in Blue represents a Transmission Function

Information shown in Red represents a Sales & Marketing Function

Last Updated 11/01/06

Fleet Management

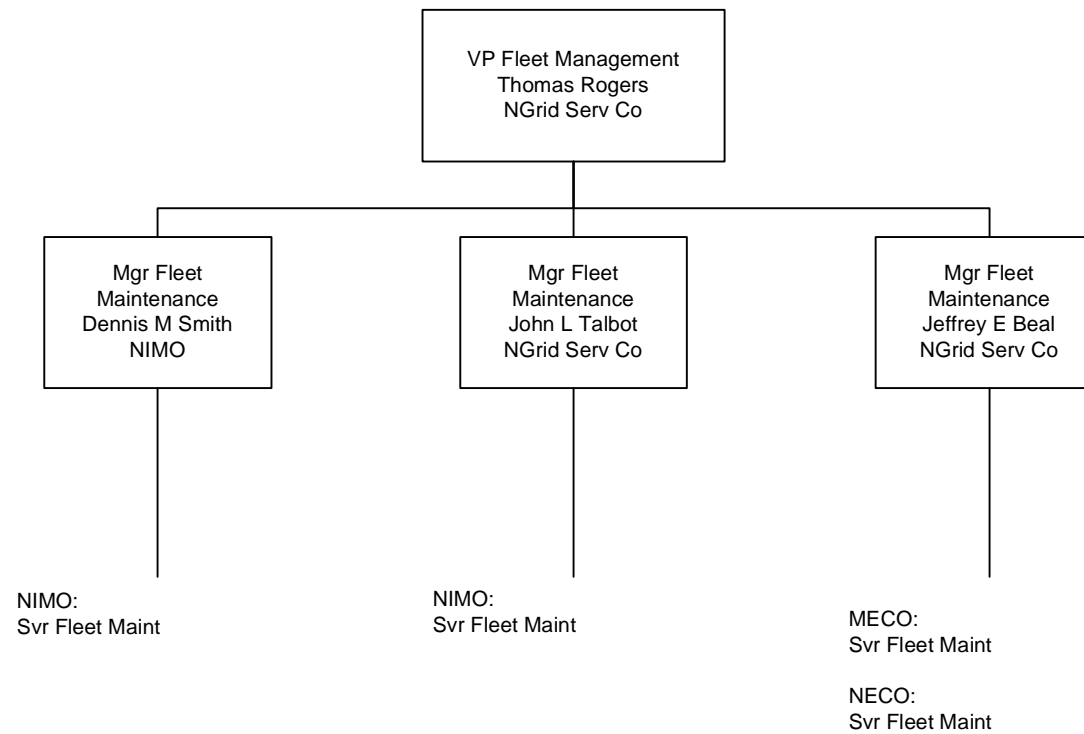

GECO = Granite State Electric Company
MECO = Massachusetts Electric Company
Nant = Nantucket Electric Company
NECO = The Narragansett Electric Company
NECO Gas = Narragansett Electric Company
NGrid Serv Co = National Grid USA Service Company Inc
NIMO = Niagara Mohawk Power Corporation
Information shown in Blue represents a Transmission Function
Information shown in Red represents a Sales & Marketing Function

Last Updated 11/01/06

Engineering and Asset Management

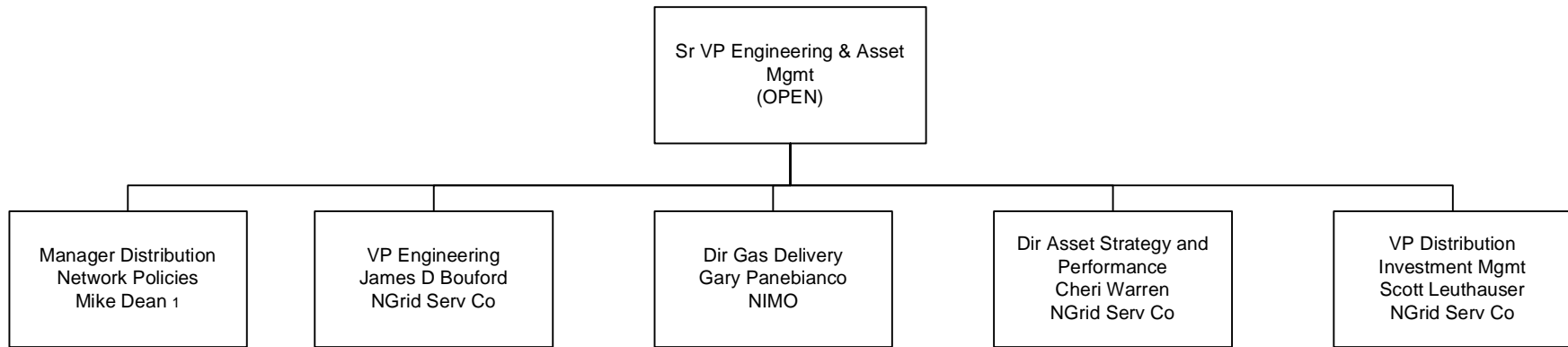

GECO = Granite State Electric Company

MECO = Massachusetts Electric Company

Nant = Nantucket Electric Company

NECO = The Narragansett Electric Company

NECO Gas = Narragansett Electric Company

NGrid Serv Co = National Grid USA Service Company Inc

NIMO = Niagara Mohawk Power Corporation

Information shown in Blue represents a Transmission Function

Information shown in Red represents a Sales & Marketing Function

Engineering Services

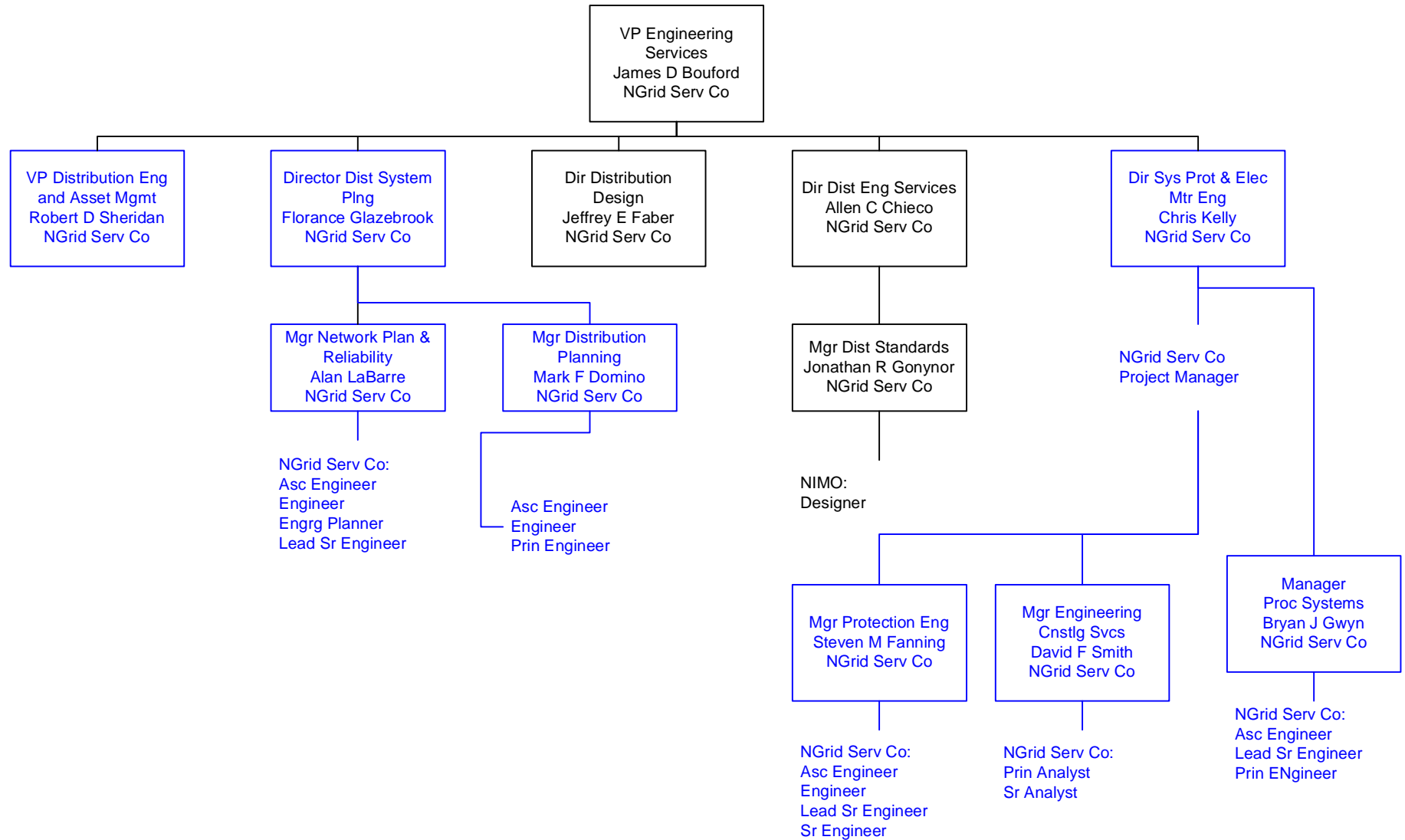

GECS = Granite State Electric Company
 MECO = Massachusetts Electric Company
 Nant = Nantucket Electric Company
 NECO = The Narragansett Electric Company
 NECO Gas = Narragansett Electric Company
 NGrid Serv Co = National Grid USA Service Company Inc
 NIMO = Niagara Mohawk Power Corporation
 Information shown in Blue represents a Transmission Function
 Information shown in Red represents a Sales & Marketing Function

Engineering Services Cont.

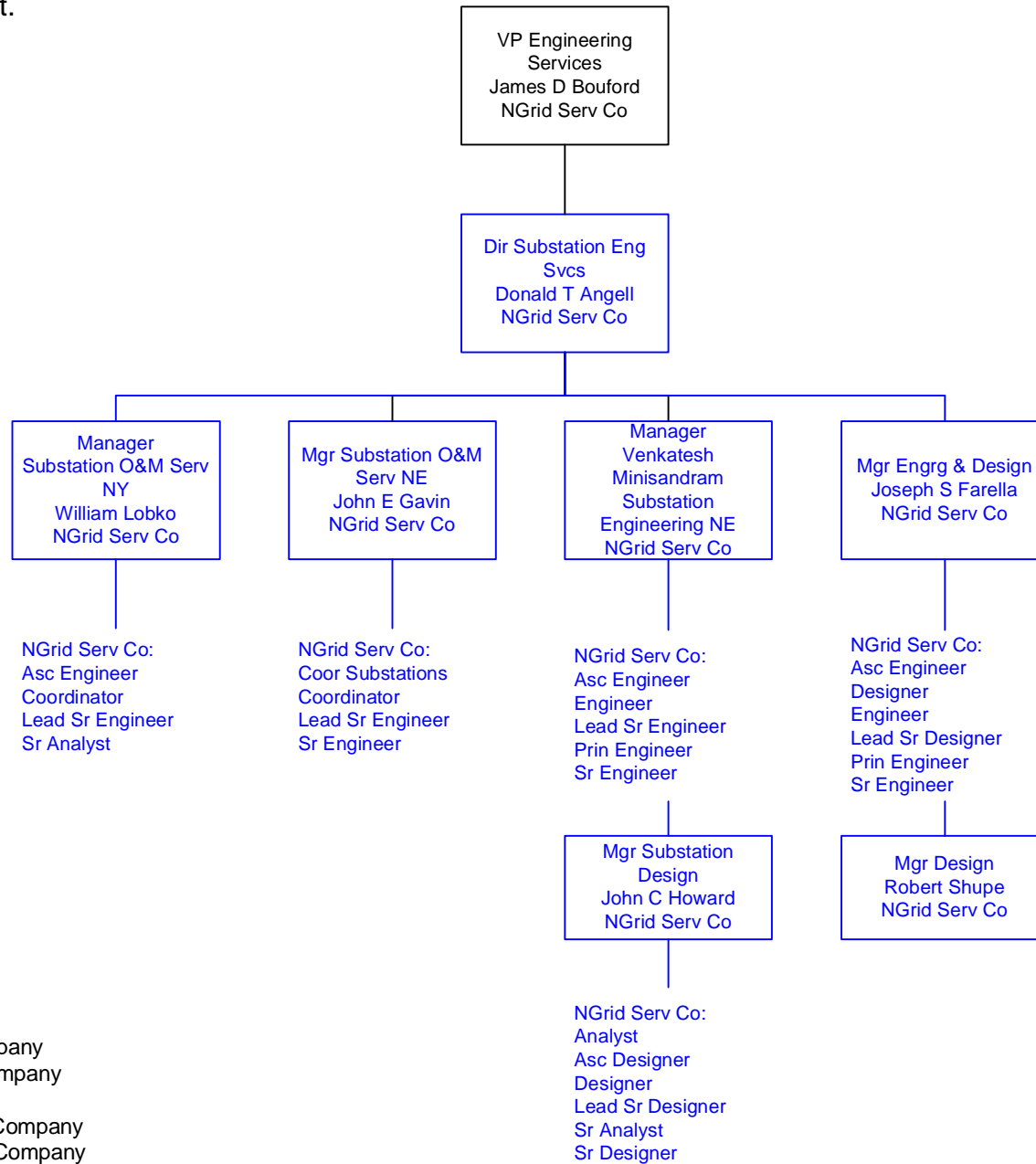

GECS = Granite State Electric Company
 MECO = Massachusetts Electric Company
 Nant = Nantucket Electric Company
 NECO = The Narragansett Electric Company
 NECO Gas = Narragansett Electric Company
 NGrid Serv Co = National Grid USA Service Company Inc
 NIMO = Niagara Mohawk Power Corporation
 Information shown in Blue represents a Transmission Function
 Information shown in Red represents a Sales & Marketing Function

Engineering and Asset Management

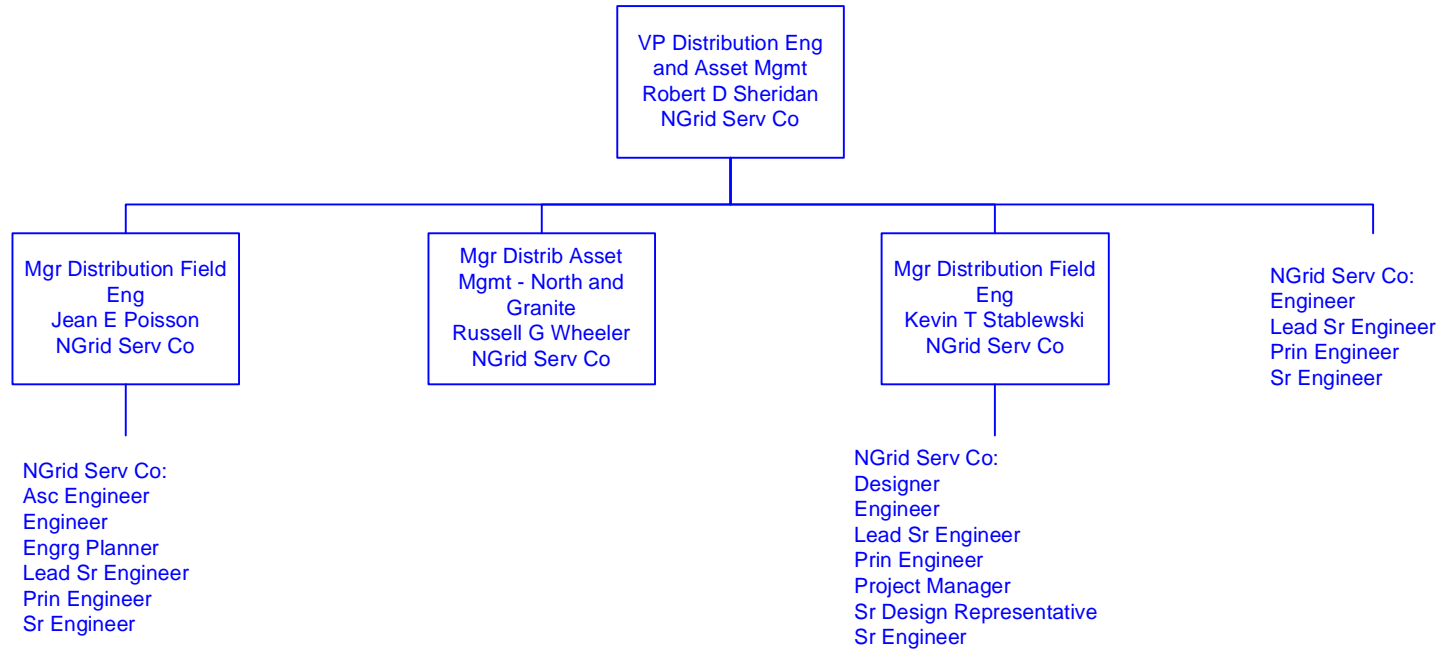

GECS = Granite State Electric Company
 MECO = Massachusetts Electric Company
 Nant = Nantucket Electric Company
 NECO = The Narragansett Electric Company
 NECO Gas = Narragansett Electric Company
 NGrid Serv Co = National Grid USA Service Company Inc
 NIMO = Niagara Mohawk Power Corporation
 Information shown in Blue represents a Transmission Function
 Information shown in Red represents a Sales & Marketing Function

Gas Distribution

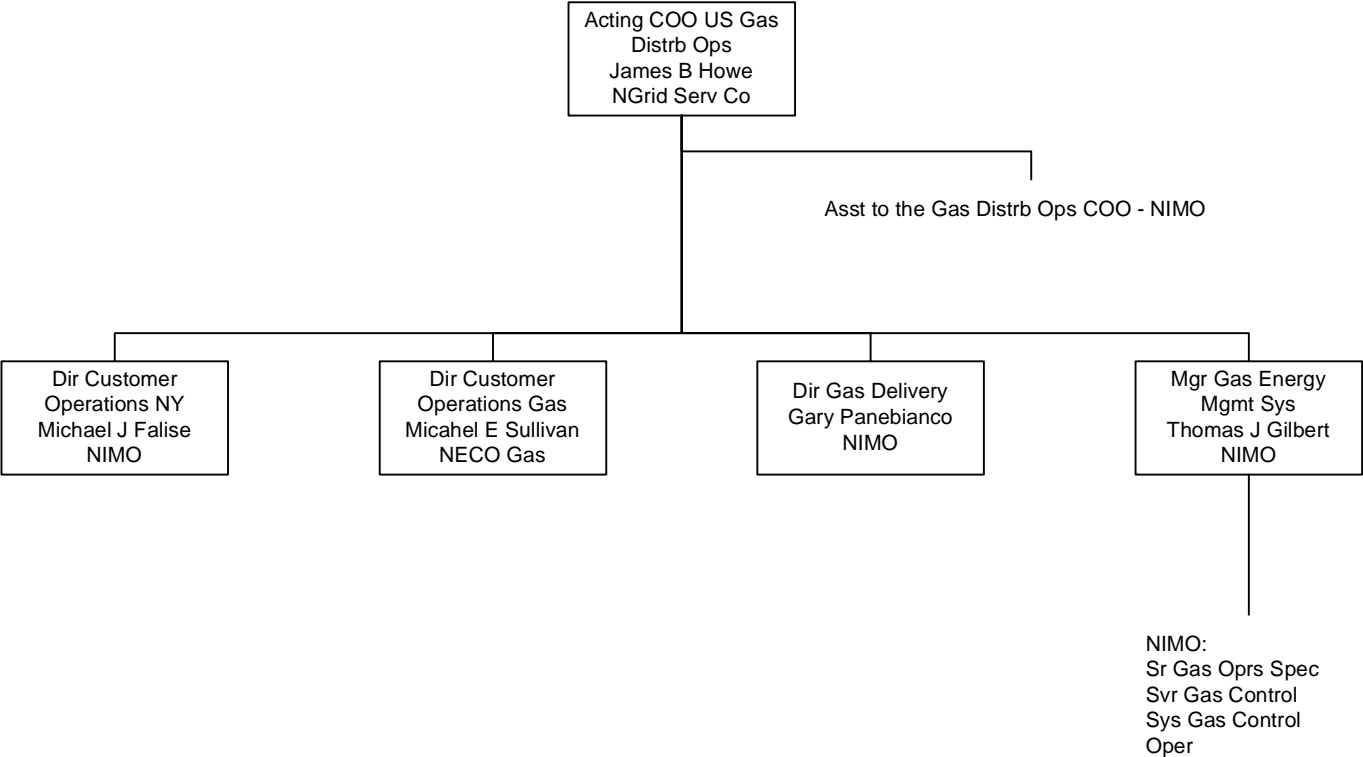

GECO = Granite State Electric Company
 MECO = Massachusetts Electric Company
 Nant = Nantucket Electric Company
 NECO = The Narragansett Electric Company
 NECO Gas = Narragansett Electric Company
 NGrid Serv Co = National Grid USA Service Company Inc
 NIMO = Niagara Mohawk Power Corporation
 Information shown in Blue represents a Transmission Function
 Information shown in Red represents a Sales & Marketing Function

Gas Delivery

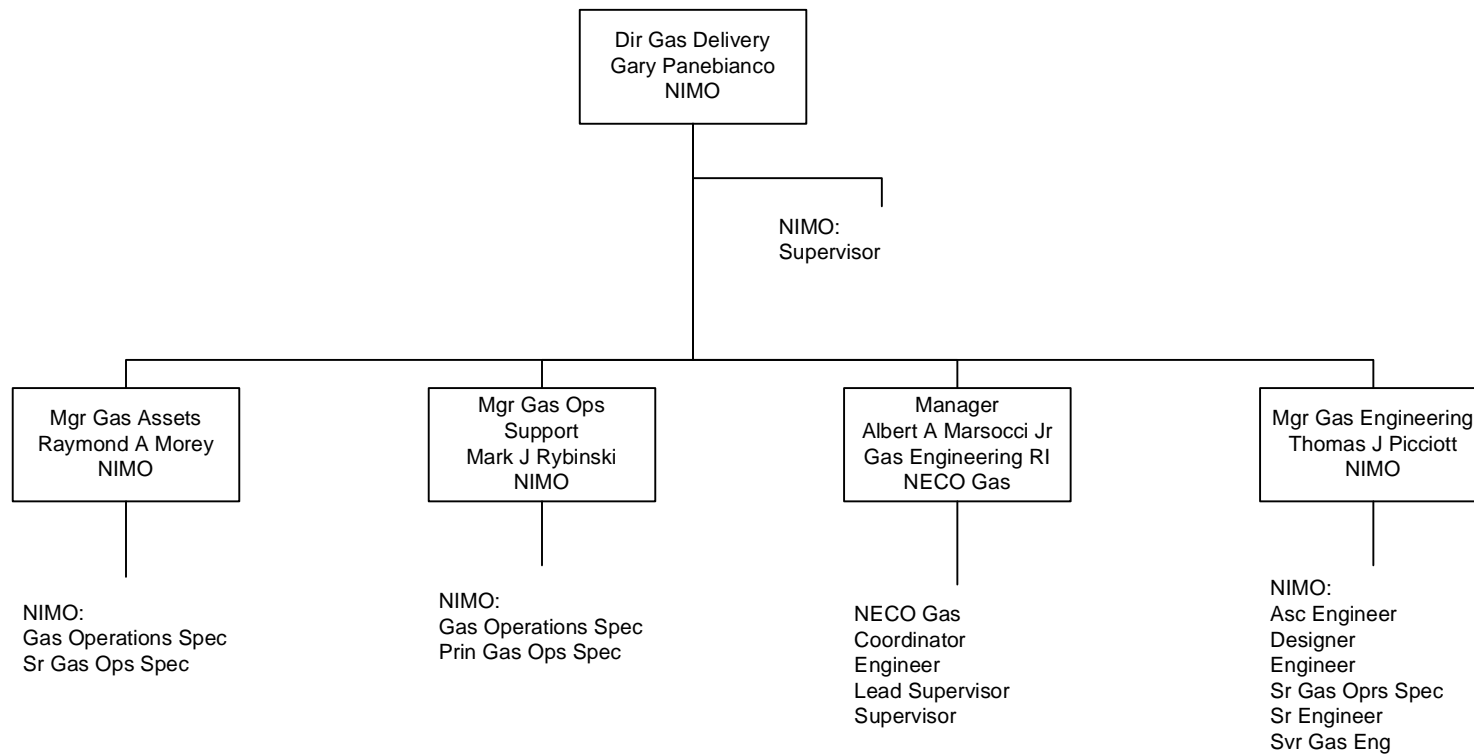

GECO = Granite State Electric Company
 MECO = Massachusetts Electric Company
 Nant = Nantucket Electric Company
 NECO = The Narragansett Electric Company
 NECO Gas = Narragansett Electric Company
 NGrid Serv Co = National Grid USA Service Company Inc
 NIMO = Niagara Mohawk Power Corporation
 Information shown in Blue represents a Transmission Function
 Information shown in Red represents a Sales & Marketing Function

New York Distribution

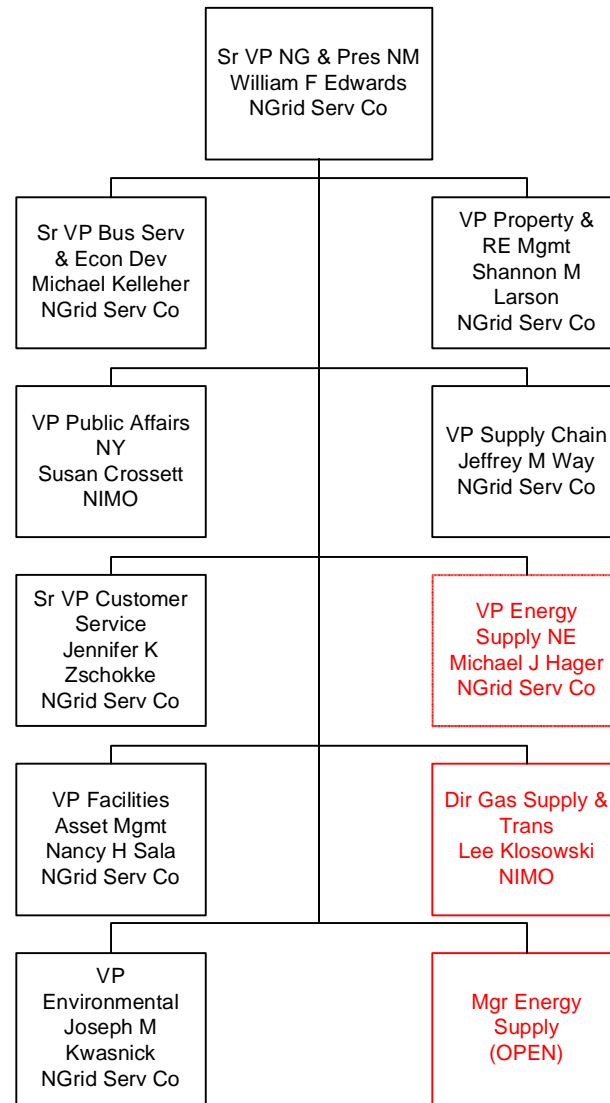

GECO = Granite State Electric Company
 MECO = Massachusetts Electric Company
 Nant = Nantucket Electric Company
 NECO = The Narragansett Electric Company
 NECO Gas = Narragansett Electric Company
 NGrid Serv Co = National Grid USA Service Company Inc
 NIMO = Niagara Mohawk Power Corporation
 Information shown in Blue represents a Transmission Function
 Information shown in Red represents a Sales & Marketing Function

Energy Supply

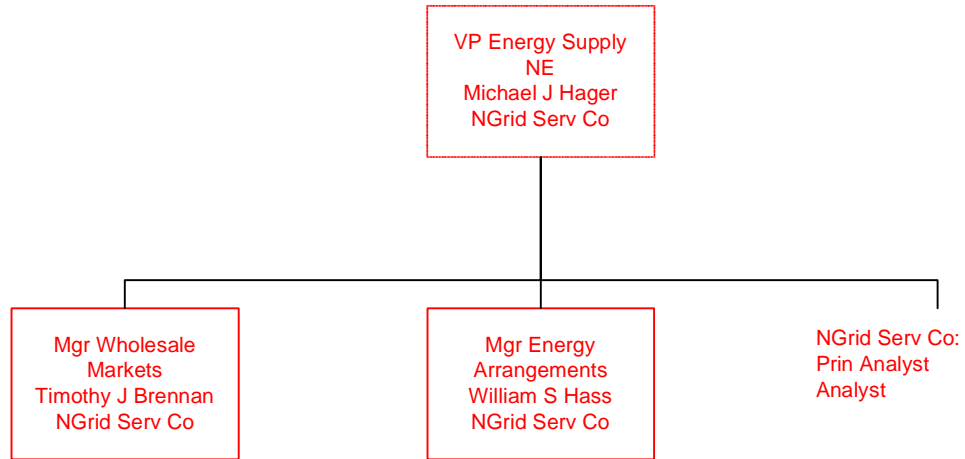

GECO = Granite State Electric Company

MECO = Massachusetts Electric Company

Nant = Nantucket Electric Company

NECO = The Narragansett Electric Company

NECO Gas = Narragansett Electric Company

NGrid Serv Co = National Grid USA Service Company Inc

NIMO = Niagara Mohawk Power Corporation

Information shown in Blue represents a Transmission Function

Information shown in Red represents a Sales & Marketing Function

Gas and Energy Supply

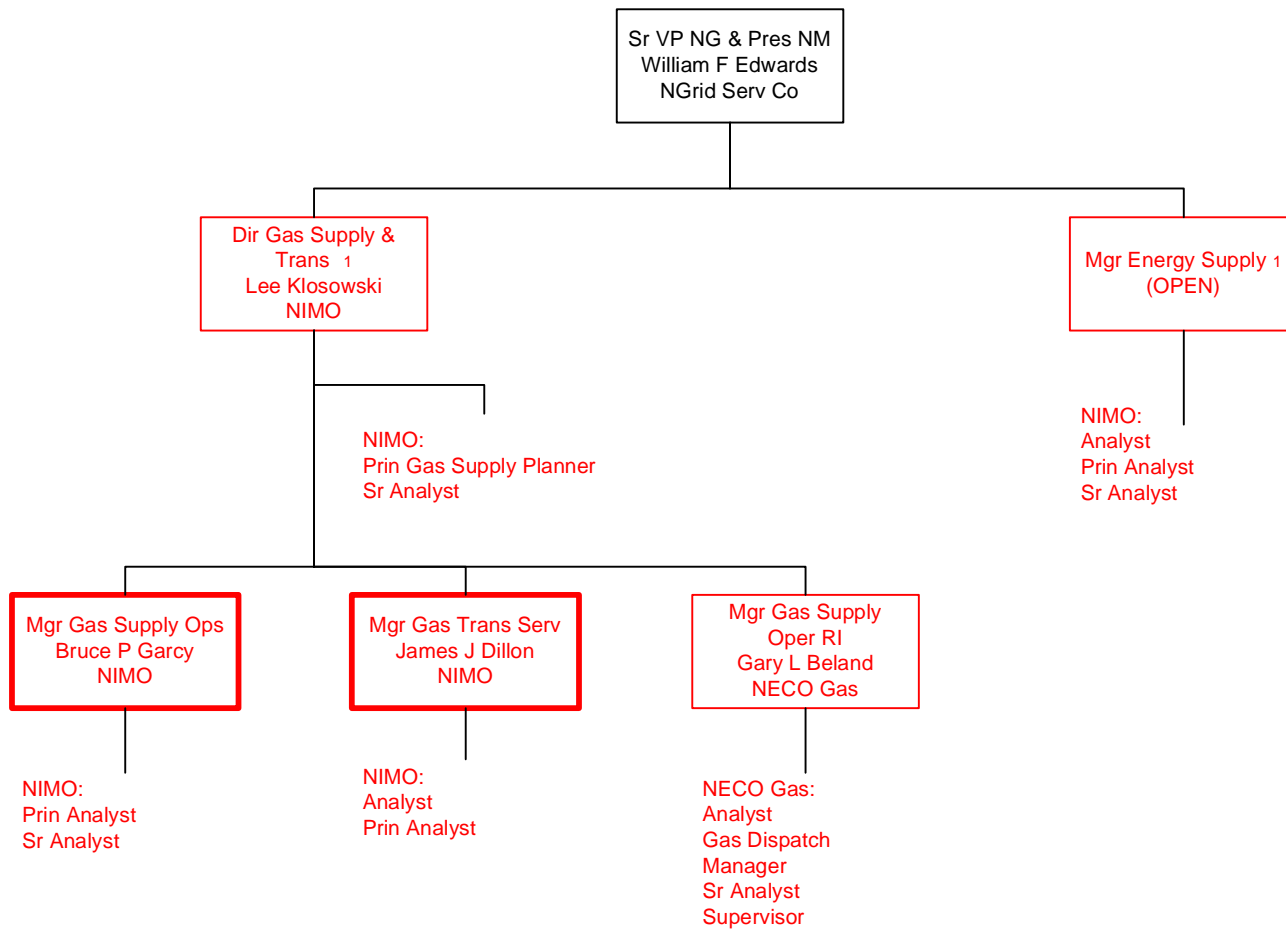

GECCO = Granite State Electric Company
 MECO = Massachusetts Electric Company
 Nant = Nantucket Electric Company
 NECO = The Narragansett Electric Company
 NECO Gas = Narragansett Electric Company
 NGrid Serv Co = National Grid USA Service Company Inc
 NIMO = Niagara Mohawk Power Corporation
 Information shown in Blue represents a Transmission Function
 Information shown in Red represents a Sales & Marketing Function

Business Services and Economic Development

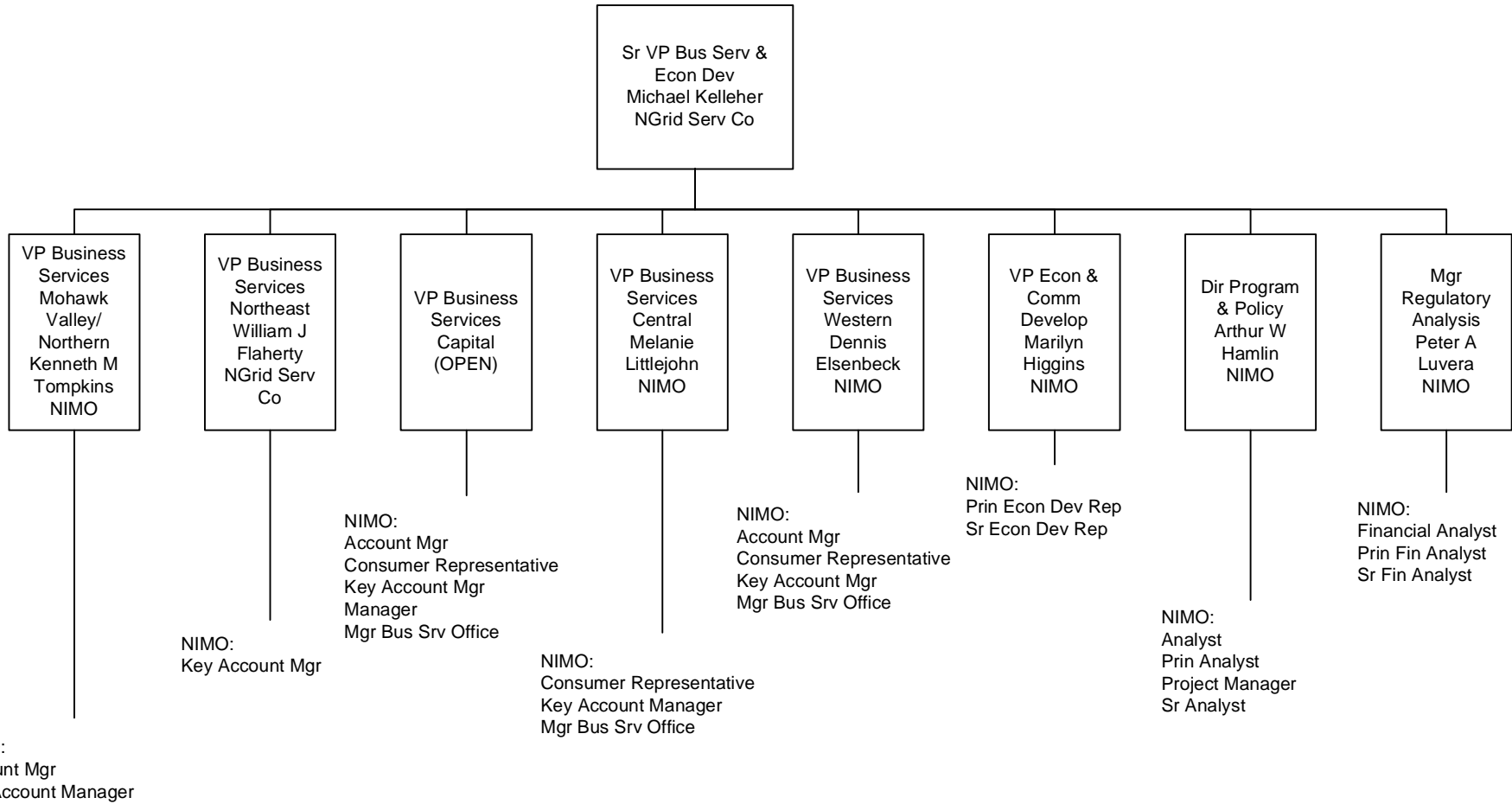

GECS = Granite State Electric Company
 MECO = Massachusetts Electric Company
 Nant = Nantucket Electric Company
 NECO = The Narragansett Electric Company
 NECO Gas = Narragansett Electric Company
 NGrid Serv Co = National Grid USA Service Company Inc
 NIMO = Niagara Mohawk Power Corporation
 Information shown in Blue represents a Transmission Function
 Information shown in Red represents a Sales & Marketing Function

Customer Service Centers

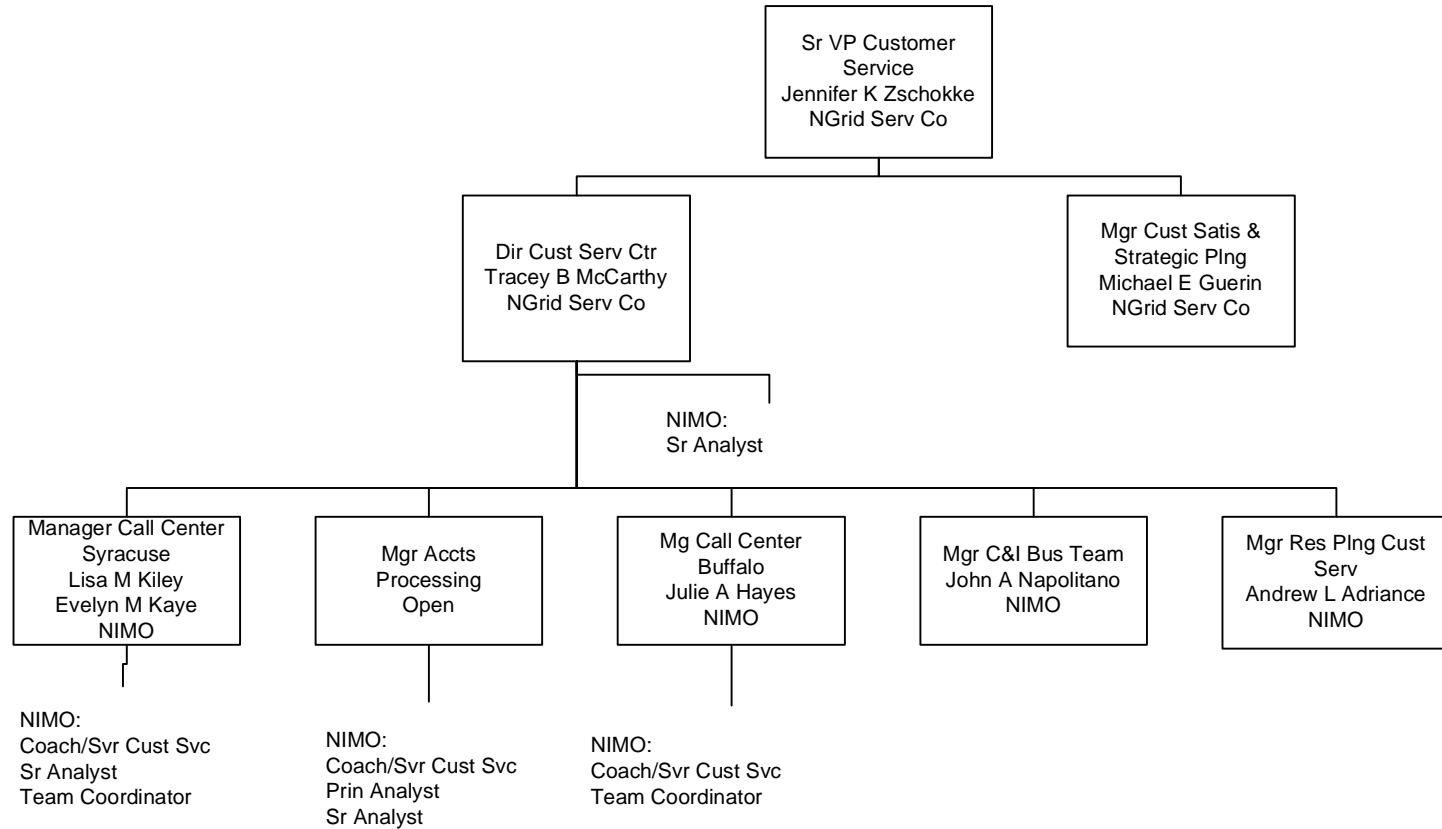

GECS = Granite State Electric Company
 MECO = Massachusetts Electric Company
 Nant = Nantucket Electric Company
 NECO = The Narragansett Electric Company
 NECO Gas = Narragansett Electric Company
 NGrid Serv Co = National Grid USA Service Company Inc
 NIMO = Niagara Mohawk Power Corporation
 Information shown in Blue represents a Transmission Function
 Information shown in Red represents a Sales & Marketing Function

Customer Service Programs

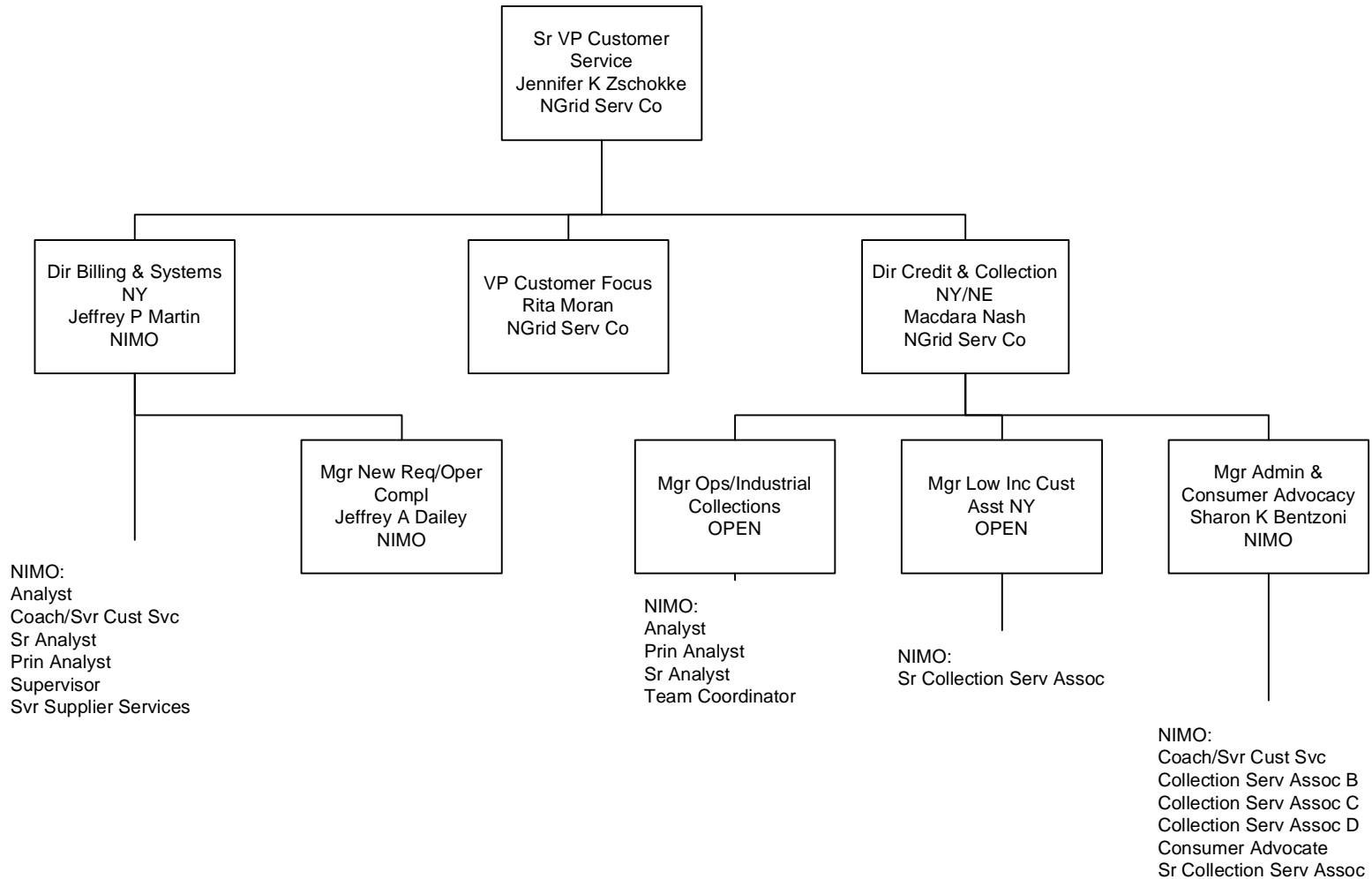

GECS = Granite State Electric Company
 MECO = Massachusetts Electric Company
 Nant = Nantucket Electric Company
 NECO = The Narragansett Electric Company
 NECO Gas = Narragansett Electric Company
 NGrid Serv Co = National Grid USA Service Company Inc
 NIMO = Niagara Mohawk Power Corporation
 Information shown in Blue represents a Transmission Function
 Information shown in Red represents a Sales & Marketing Function

Last Updated 01/09/07

Customer Satisfaction and Strategic Planning and Support

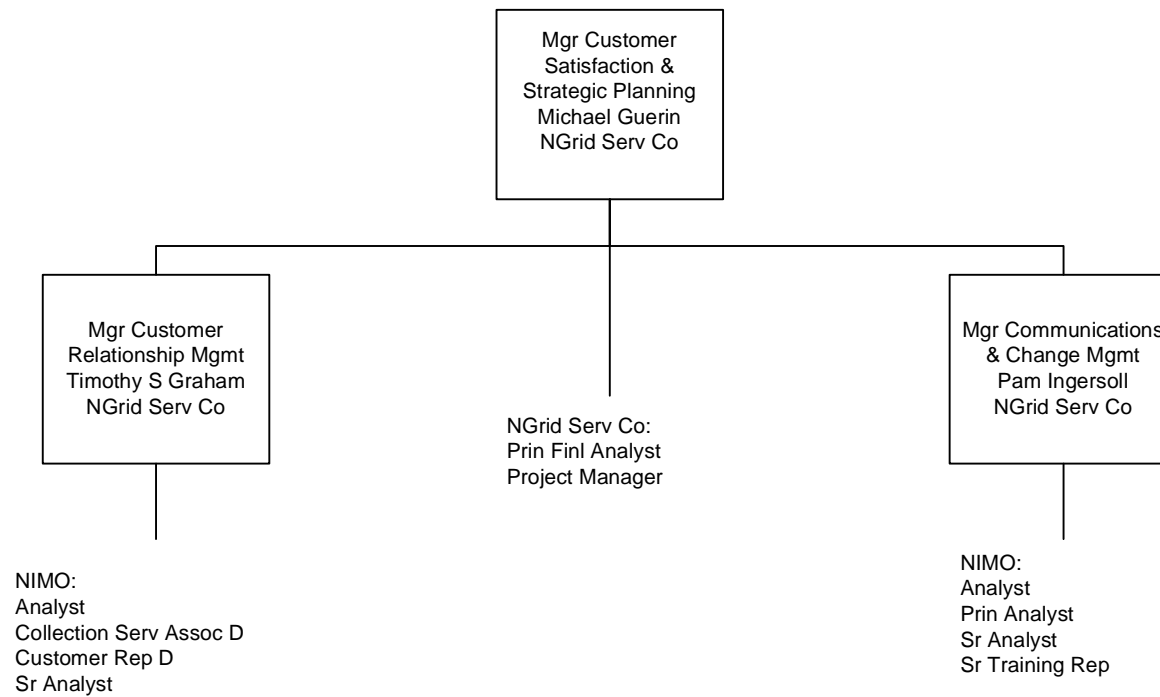

GECO = Granite State Electric Company

MECO = Massachusetts Electric Company

Nant = Nantucket Electric Company

NECO = The Narragansett Electric Company

NECO Gas = Narragansett Electric Company

NGrid Serv Co = National Grid USA Service Company Inc

NIMO = Niagara Mohawk Power Corporation

Information shown in Blue represents a Transmission Function

Information shown in Red represents a Sales & Marketing Function

Environmental

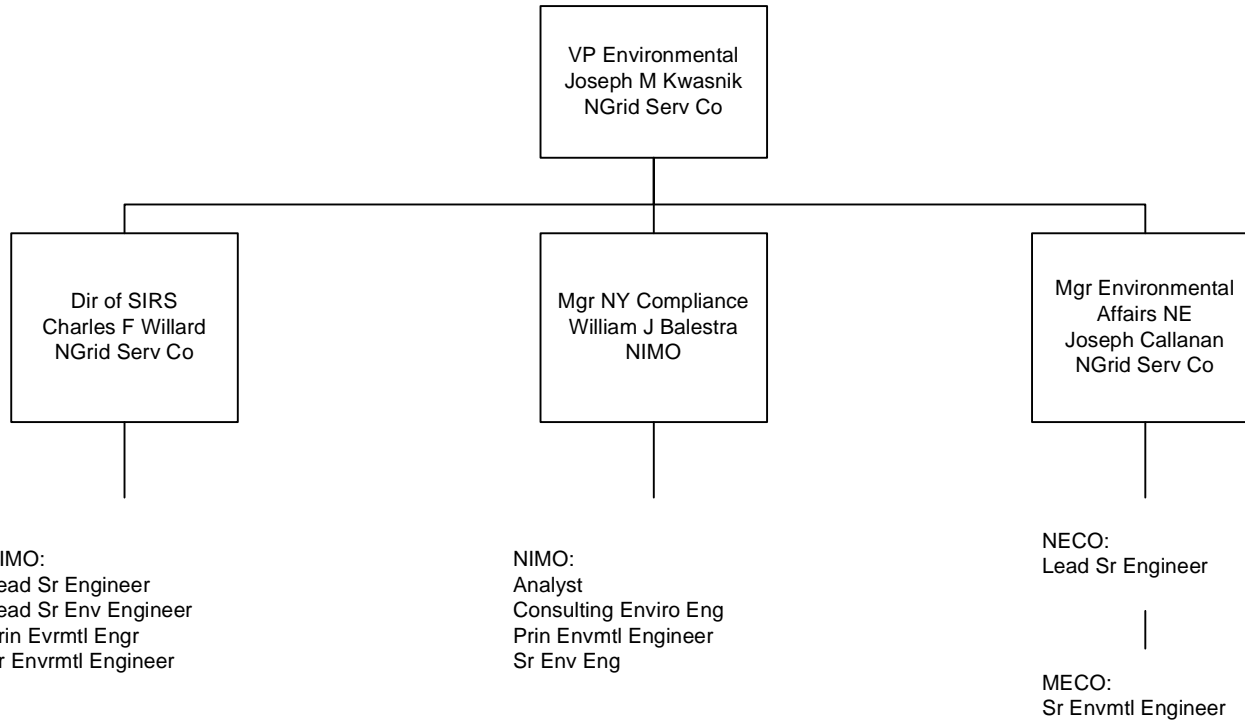

GECO = Granite State Electric Company
 MECO = Massachusetts Electric Company
 Nant = Nantucket Electric Company
 NECO = The Narragansett Electric Company
 NECO Gas = Narragansett Electric Company
 NGrid Serv Co = National Grid USA Service Company Inc
 NIMO = Niagara Mohawk Power Corporation
 Information shown in Blue represents a Transmission Function
 Information shown in Red represents a Sales & Marketing Function

Supply Chain Management

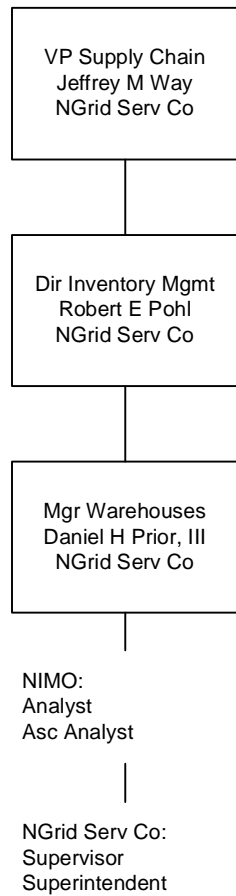

GECO = Granite State Electric Company
MECO = Massachusetts Electric Company
Nant = Nantucket Electric Company
NECO = The Narragansett Electric Company
NECO Gas = Narragansett Electric Company
NGrid Serv Co = National Grid USA Service Company Inc
NIMO = Niagara Mohawk Power Corporation
Information shown in Blue represents a Transmission Function
Information shown in Red represents a Sales & Marketing Function

Last Updated 11/01/06

Real Estate Management and Property Tax

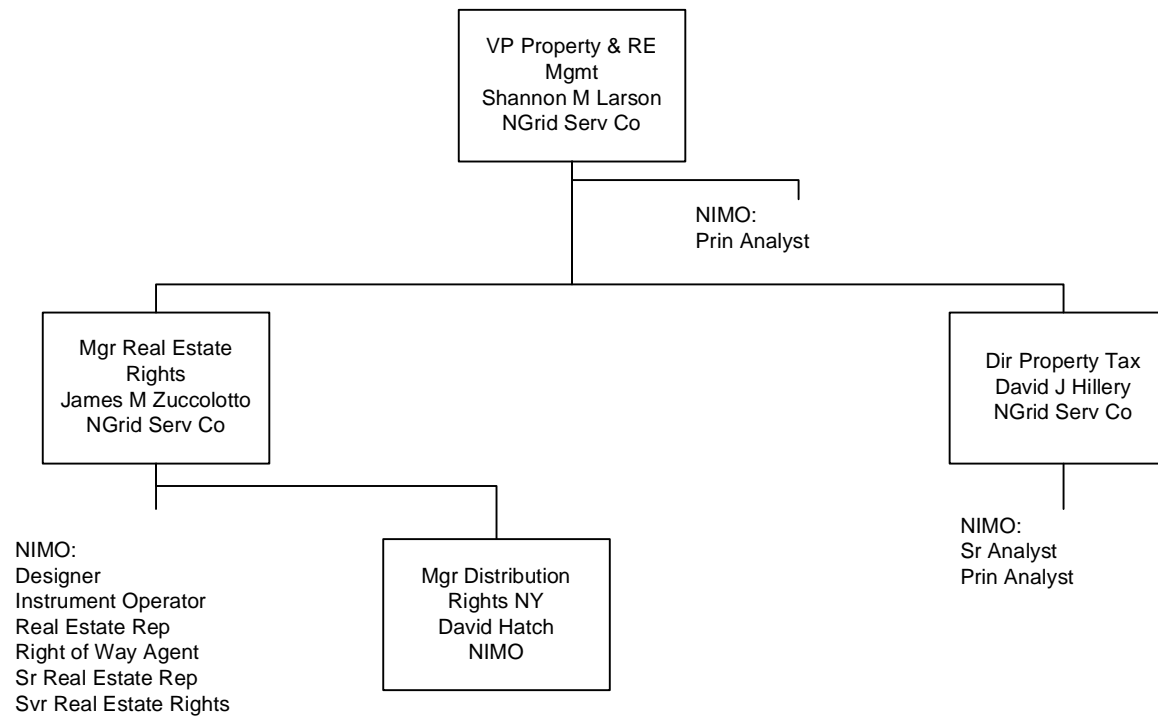

GECO = Granite State Electric Company
 MECO = Massachusetts Electric Company
 Nant = Nantucket Electric Company
 NECO = The Narragansett Electric Company
 NECO Gas = Narragansett Electric Company
 NGrid Serv Co = National Grid USA Service Company Inc
 NIMO = Niagara Mohawk Power Corporation
 Information shown in Blue represents a Transmission Function
 Information shown in Red represents a Sales & Marketing Function

Property and Real Estate Management Facilities

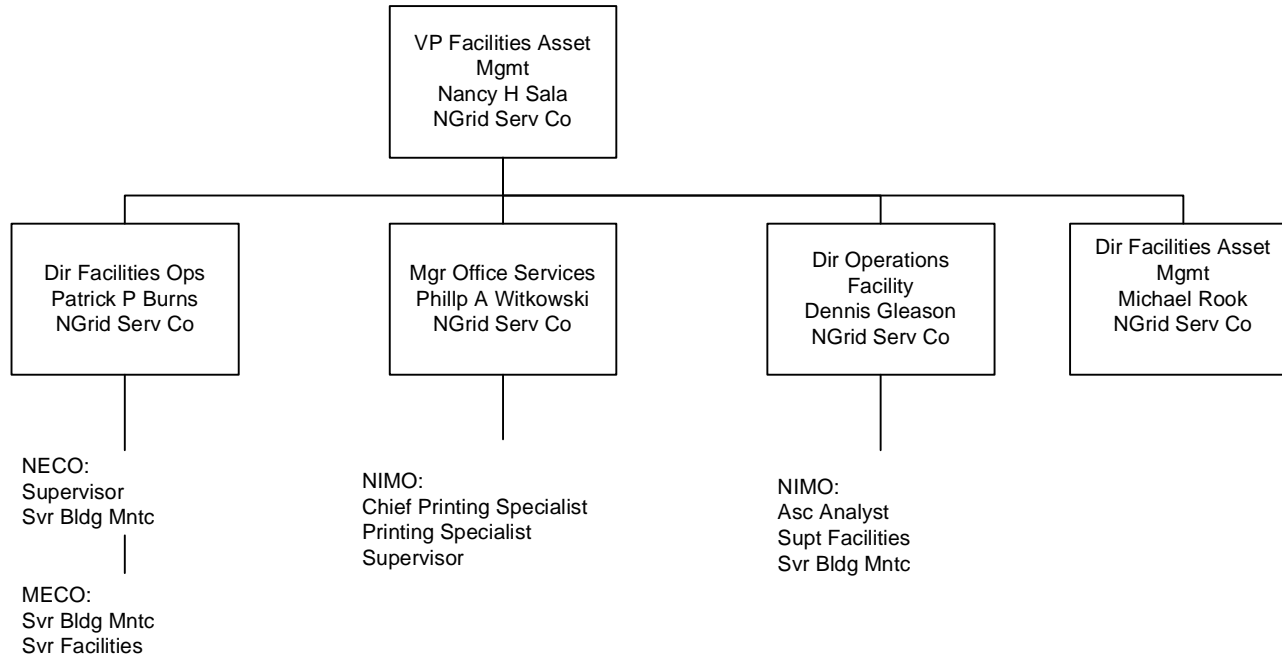

GECO = Granite State Electric Company

MECO = Massachusetts Electric Company

Nant = Nantucket Electric Company

NECO = The Narragansett Electric Company

NECO Gas = Narragansett Electric Company

NGrid Serv Co = National Grid USA Service Company Inc

NIMO = Niagara Mohawk Power Corporation

Information shown in Blue represents a Transmission Function

Information shown in Red represents a Sales & Marketing Function

Last Updated 11/01/06

Information Technology

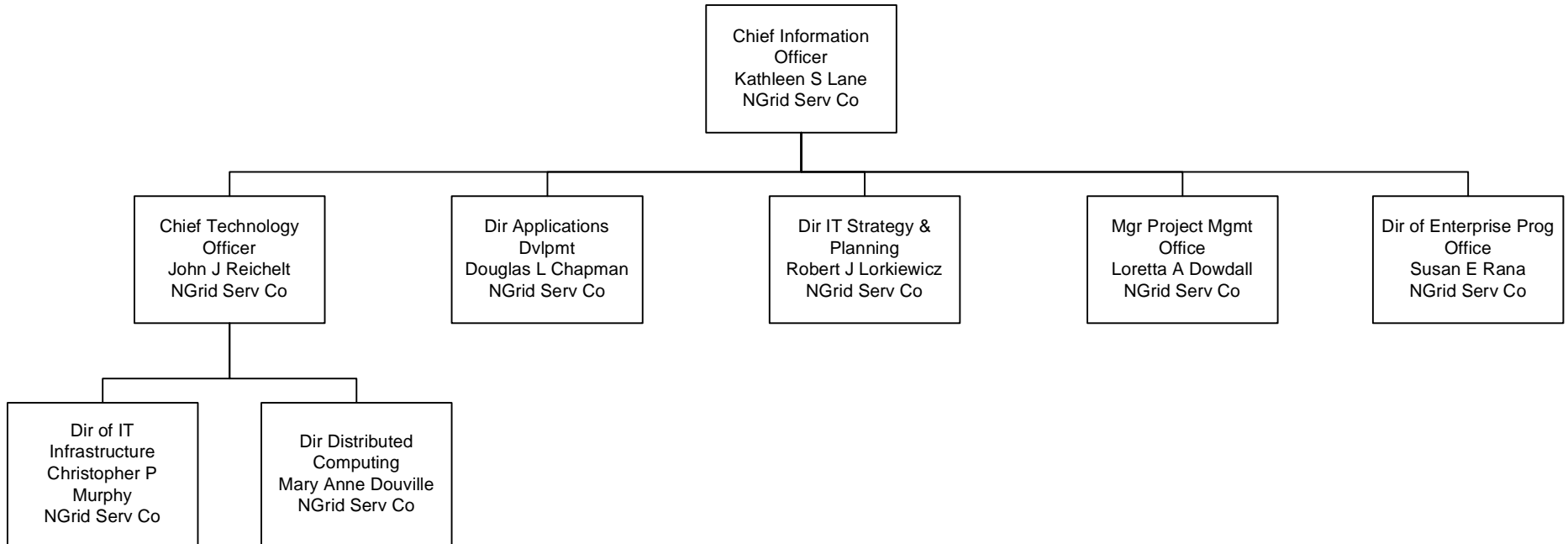

GECO = Granite State Electric Company
 MECO = Massachusetts Electric Company
 Nant = Nantucket Electric Company
 NECO = The Narragansett Electric Company
 NECO Gas = Narragansett Electric Company
 NGrid Serv Co = National Grid USA Service Company Inc
 NIMO = Niagara Mohawk Power Corporation
 Information shown in Blue represents a Transmission Function
 Information shown in Red represents a Sales & Marketing Function

Information Technology Application Development

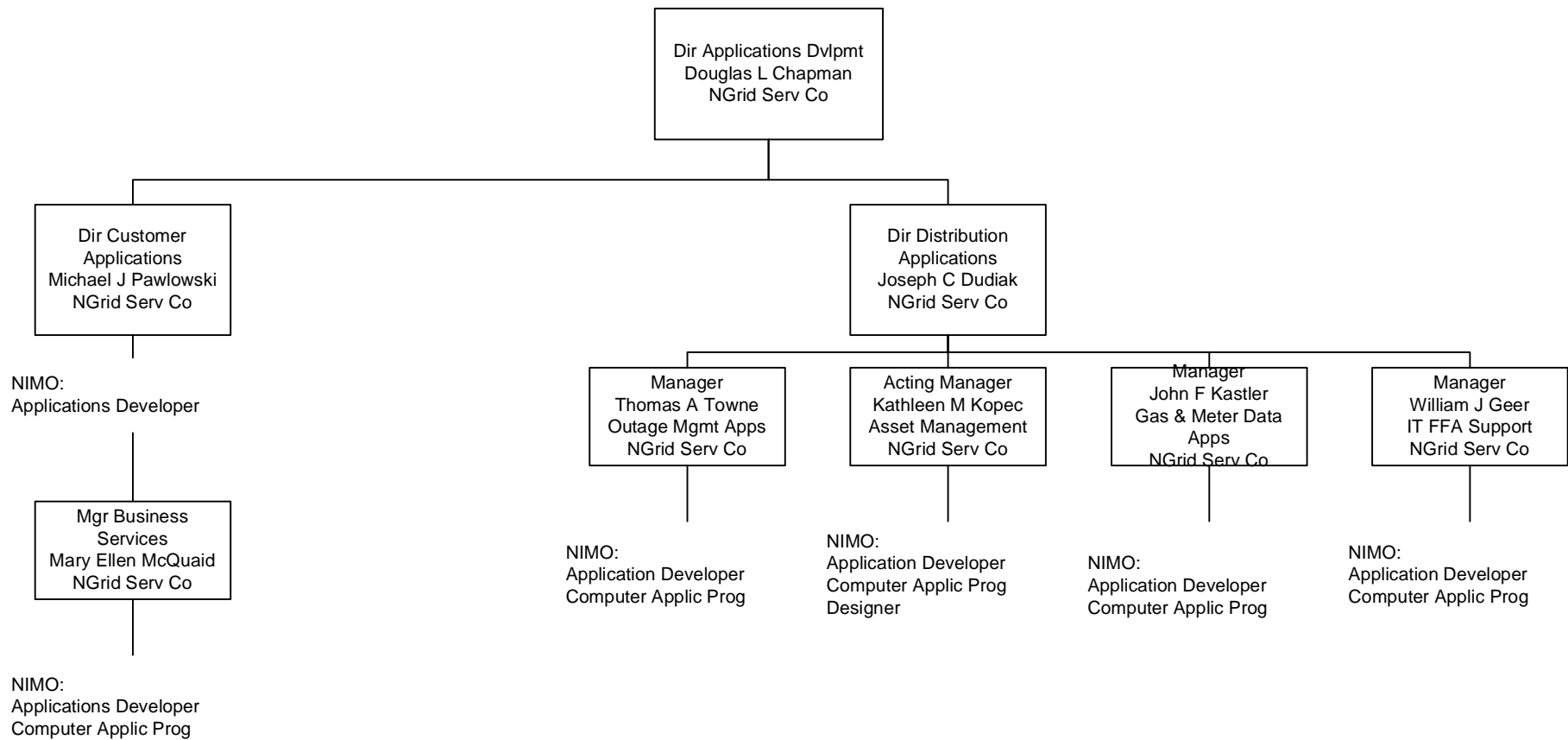

GECCO = Granite State Electric Company
 MECO = Massachusetts Electric Company
 Nant = Nantucket Electric Company
 NECO = The Narragansett Electric Company
 NECO Gas = Narragansett Electric Company
 NGrid Serv Co = National Grid USA Service Company Inc
 NIMO = Niagara Mohawk Power Corporation
 Information shown in Blue represents a Transmission Function
 Information shown in Red represents a Sales & Marketing Function

Information Technology Infrastructure

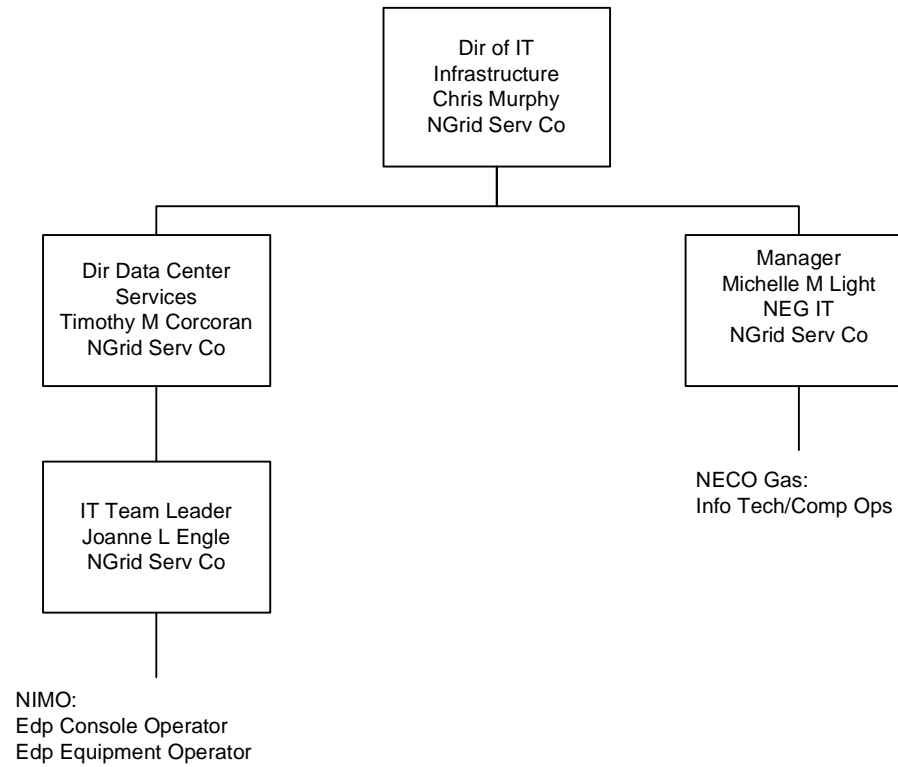

GECS = Granite State Electric Company
 MECO = Massachusetts Electric Company
 Nant = Nantucket Electric Company
 NECO = The Narragansett Electric Company
 NECO Gas = Narragansett Electric Company
 NGrid Serv Co = National Grid USA Service Company Inc
 NIMO = Niagara Mohawk Power Corporation
 Information shown in Blue represents a Transmission Function
 Information shown in Red represents a Sales & Marketing Function

Business Development

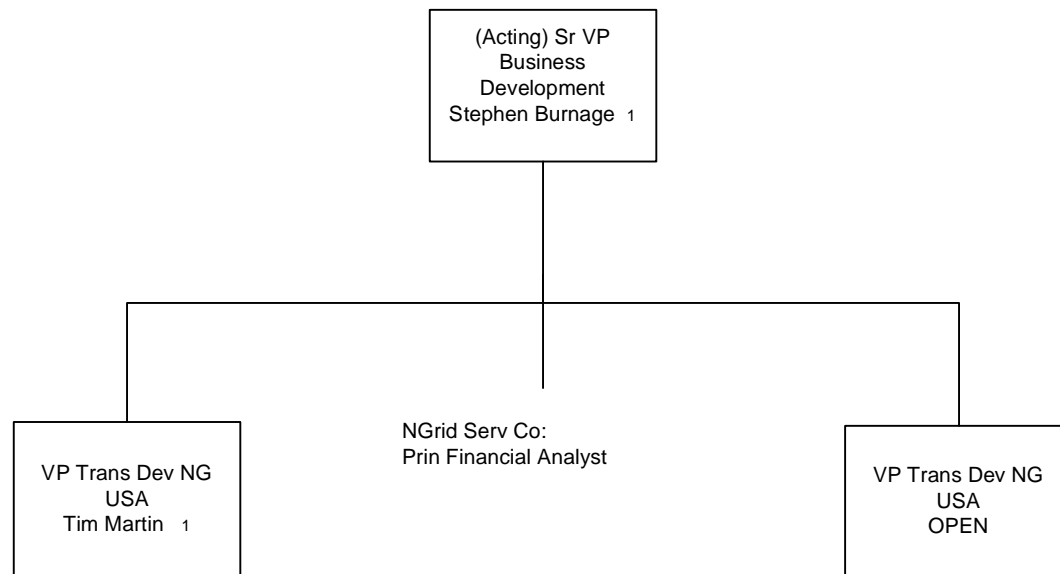

GECO = Granite State Electric Company
MECO = Massachusetts Electric Company
Nant = Nantucket Electric Company
NECO = The Narragansett Electric Company
NECO Gas = Narragansett Electric Company
NGrid Serv Co = National Grid USA Service Company Inc
NIMO = Niagara Mohawk Power Corporation
Information shown in Blue represents a Transmission Function
Information shown in Red represents a Sales & Marketing Function

Mergers and Aquisitions

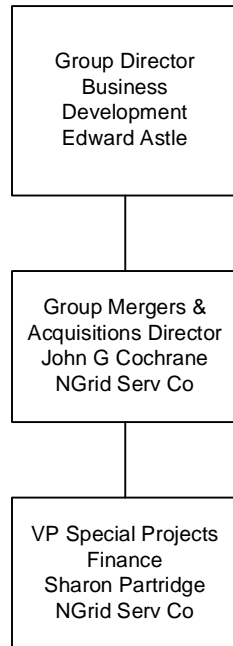

GECO = Granite State Electric Company

MECO = Massachusetts Electric Company

Nant = Nantucket Electric Company

NECO = The Narragansett Electric Company

NECO Gas = Narragansett Electric Company

NGrid Serv Co = National Grid USA Service Company Inc

NIMO = Niagara Mohawk Power Corporation

Information shown in Blue represents a Transmission Function

Information shown in Red represents a Sales & Marketing Function

Last Updated 11/01/06

Finance - CFO

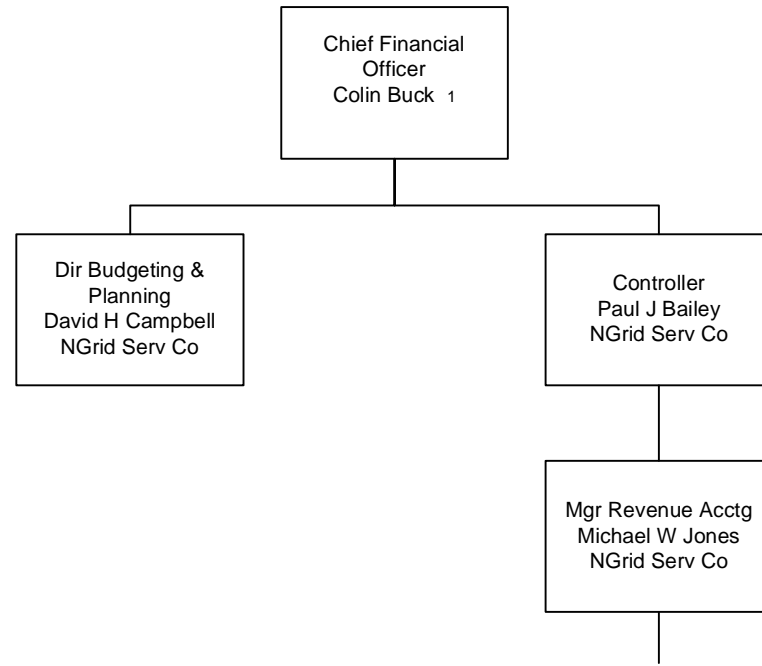

NIMO:
Prin Acctg Analyst
Sr Acctg Analyst
Svr Payments & Controls

GECO = Granite State Electric Company
MECO = Massachusetts Electric Company
Nant = Nantucket Electric Company
NECO = The Narragansett Electric Company
NECO Gas = Narragansett Electric Company
NGrid Serv Co = National Grid USA Service Company Inc
NIMO = Niagara Mohawk Power Corporation
Information shown in Blue represents a Transmission Function
Information shown in Red represents a Sales & Marketing Function

Finance

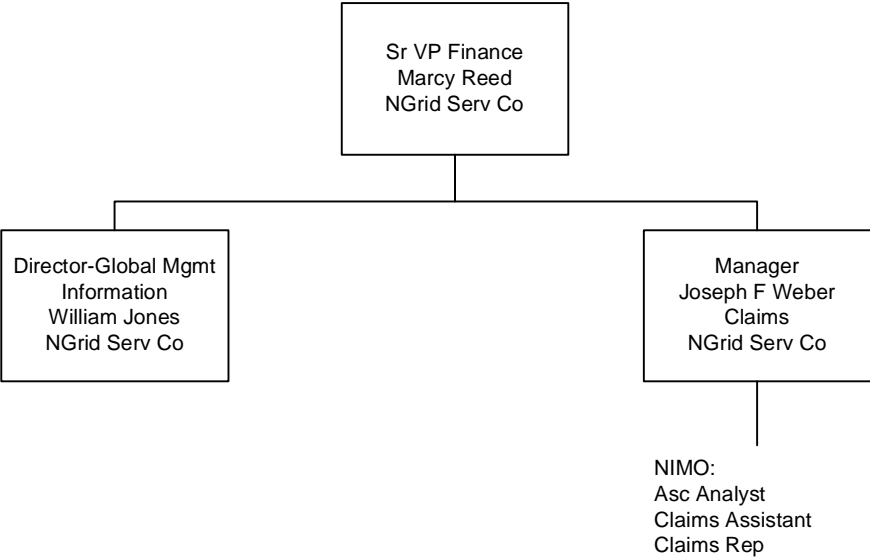

GECO = Granite State Electric Company
MECO = Massachusetts Electric Company
Nant = Nantucket Electric Company
NECO = The Narragansett Electric Company
NECO Gas = Narragansett Electric Company
NGrid Serv Co = National Grid USA Service Company Inc
NIMO = Niagara Mohawk Power Corporation
Information shown in Blue represents a Transmission Function
Information shown in Red represents a Sales & Marketing Function

Last Updated 12/11/06

Human Resources

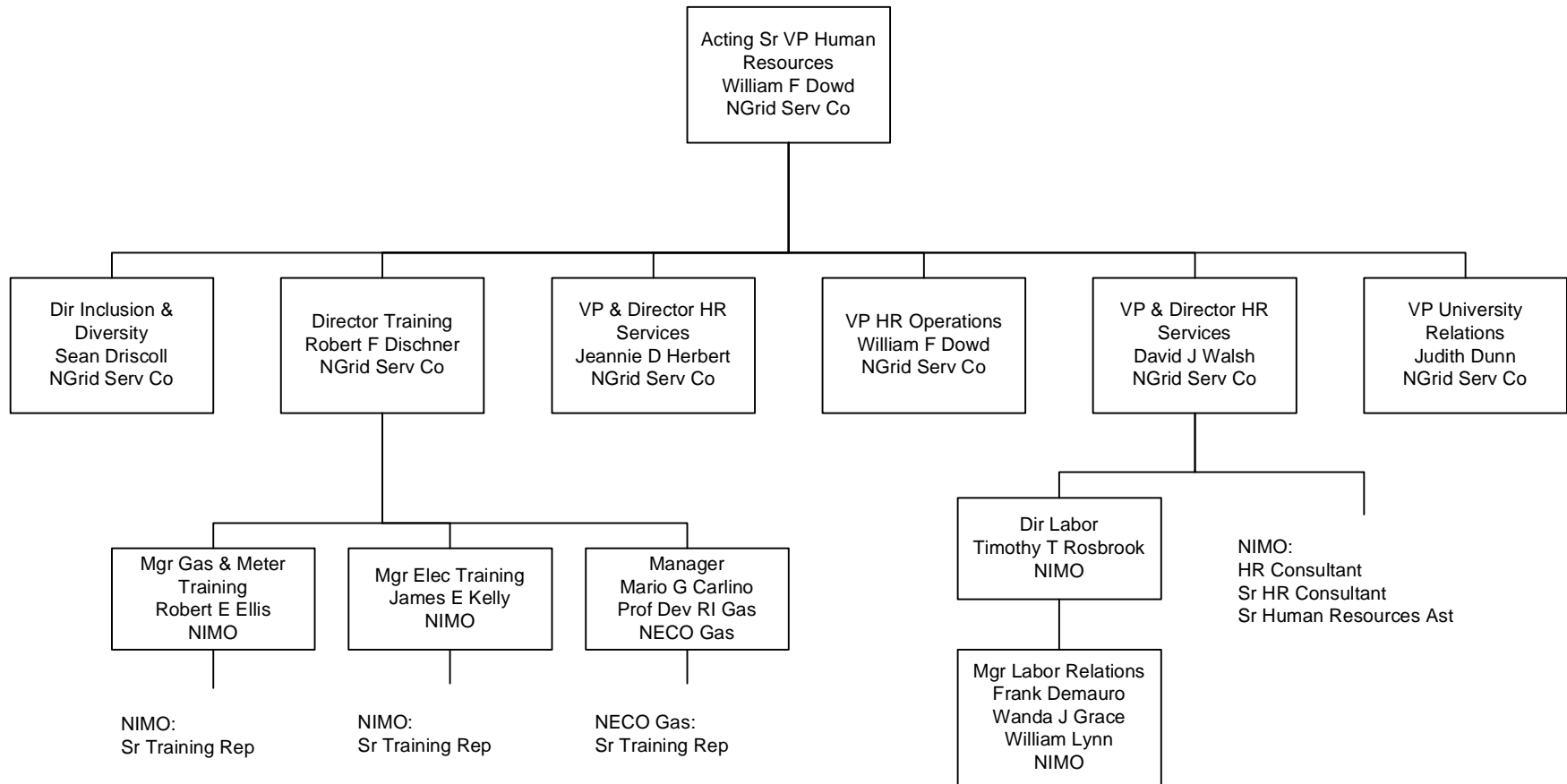

GECCO = Granite State Electric Company
 MECO = Massachusetts Electric Company
 Nant = Nantucket Electric Company
 NECO = The Narragansett Electric Company
 NECO Gas = Narragansett Electric Company
 NGrid Serv Co = National Grid USA Service Company Inc
 NIMO = Niagara Mohawk Power Corporation
 Information shown in Blue represents a Transmission Function
 Information shown in Red represents a Sales & Marketing Function

Legal

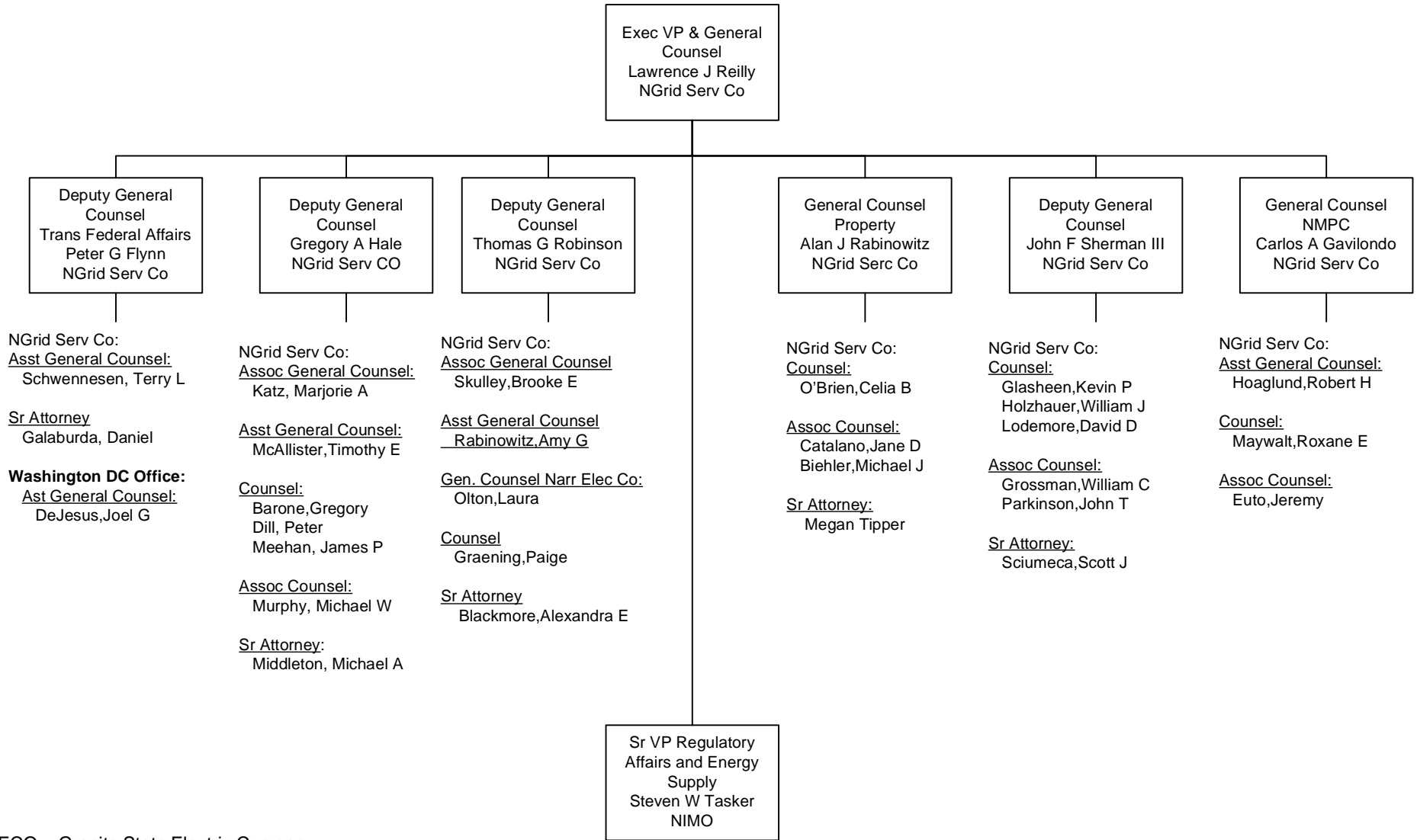

GECO = Granite State Electric Company
 MECO = Massachusetts Electric Company
 Nant = Nantucket Electric Company
 NECO = The Narragansett Electric Company
 NECO Gas = Narragansett Electric Company
 NGrid Serv Co = National Grid USA Service Company Inc
 NIMO = Niagara Mohawk Power Corporation
 Information shown in Blue represents a Transmission Function
 Information shown in Red represents a Sales & Marketing Function

Legal and External Relations

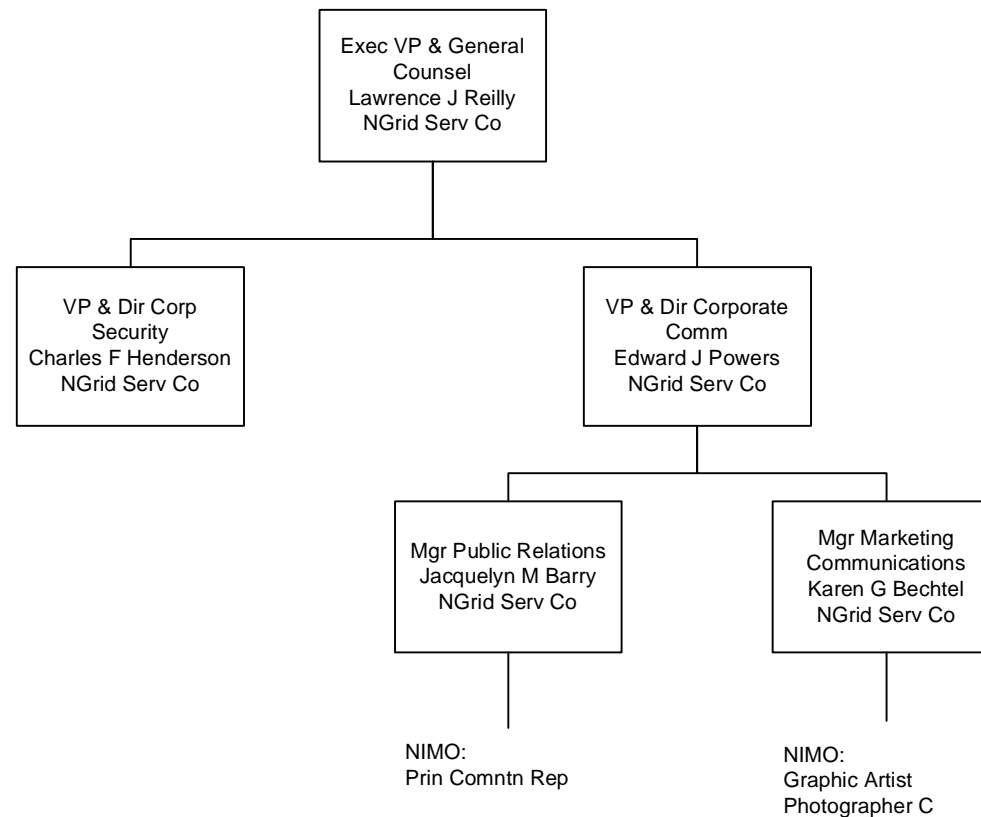

GECO = Granite State Electric Company

MECO = Massachusetts Electric Company

Nant = Nantucket Electric Company

NECO = The Narragansett Electric Company

NECO Gas = Narragansett Electric Company

NGrid Serv Co = National Grid USA Service Company Inc

NIMO = Niagara Mohawk Power Corporation

Information shown in Blue represents a Transmission Function

Information shown in Red represents a Sales & Marketing Function

Last Updated 11/01/06

New York Regulatory Affairs

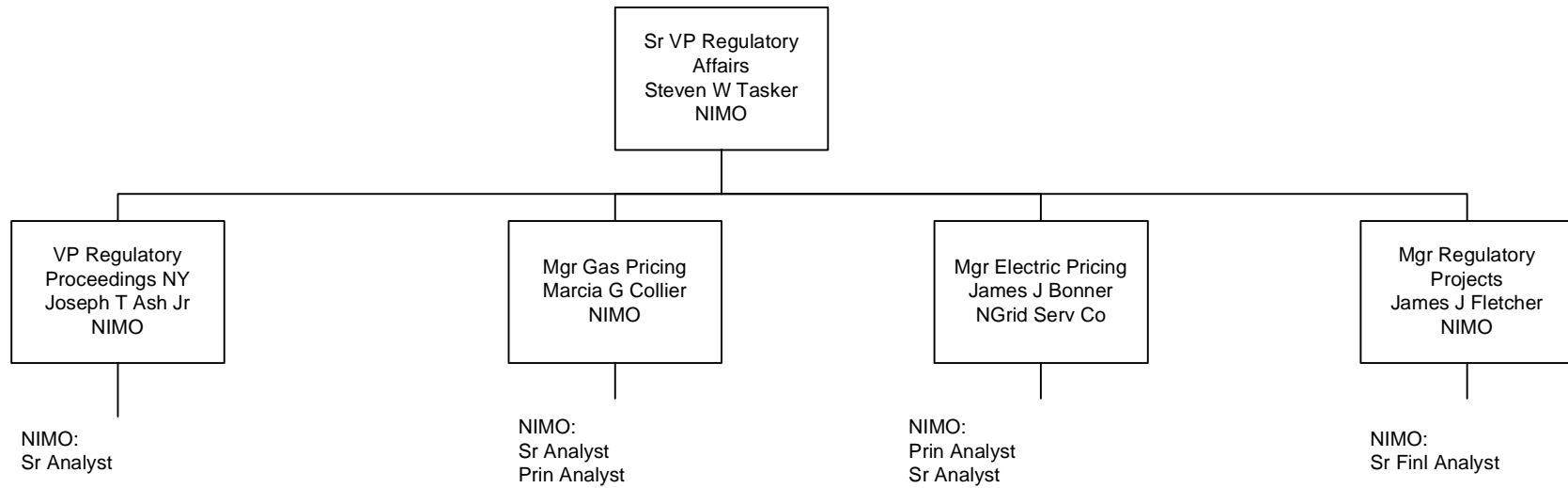

GECO = Granite State Electric Company
MECO = Massachusetts Electric Company
Nant = Nantucket Electric Company
NECO = The Narragansett Electric Company
NECO Gas = Narragansett Electric Company
NGrid Serv Co = National Grid USA Service Company Inc
NIMO = Niagara Mohawk Power Corporation
Information shown in Blue represents a Transmission Function
Information shown in Red represents a Sales & Marketing Function