

# Transmission

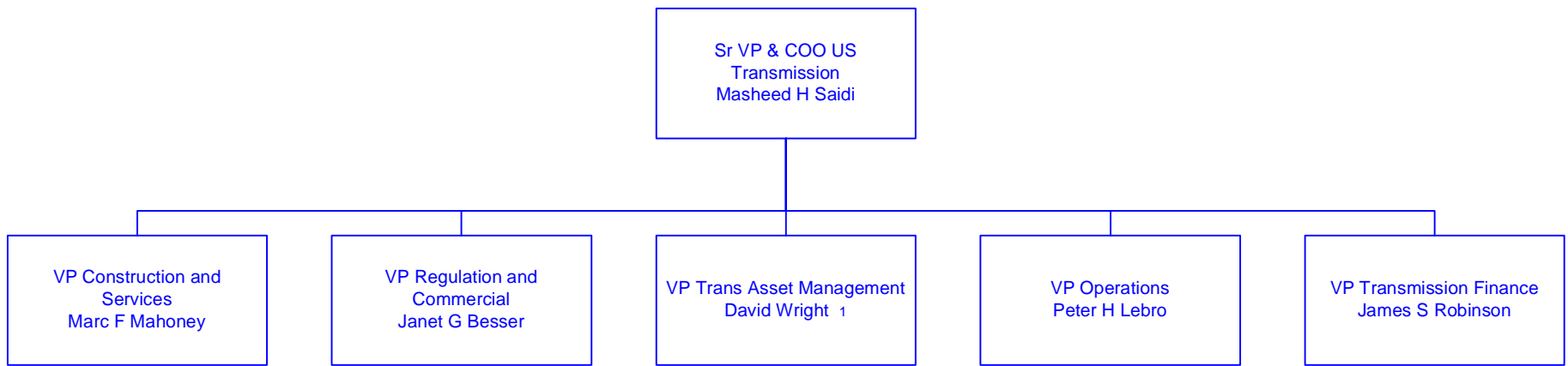

All employees shown on this page are employed by National Grid USA Service Co.  
Information shown in blue represents a Transmission Function

Last Updated 11/01/06

# Transmission Construction and Services

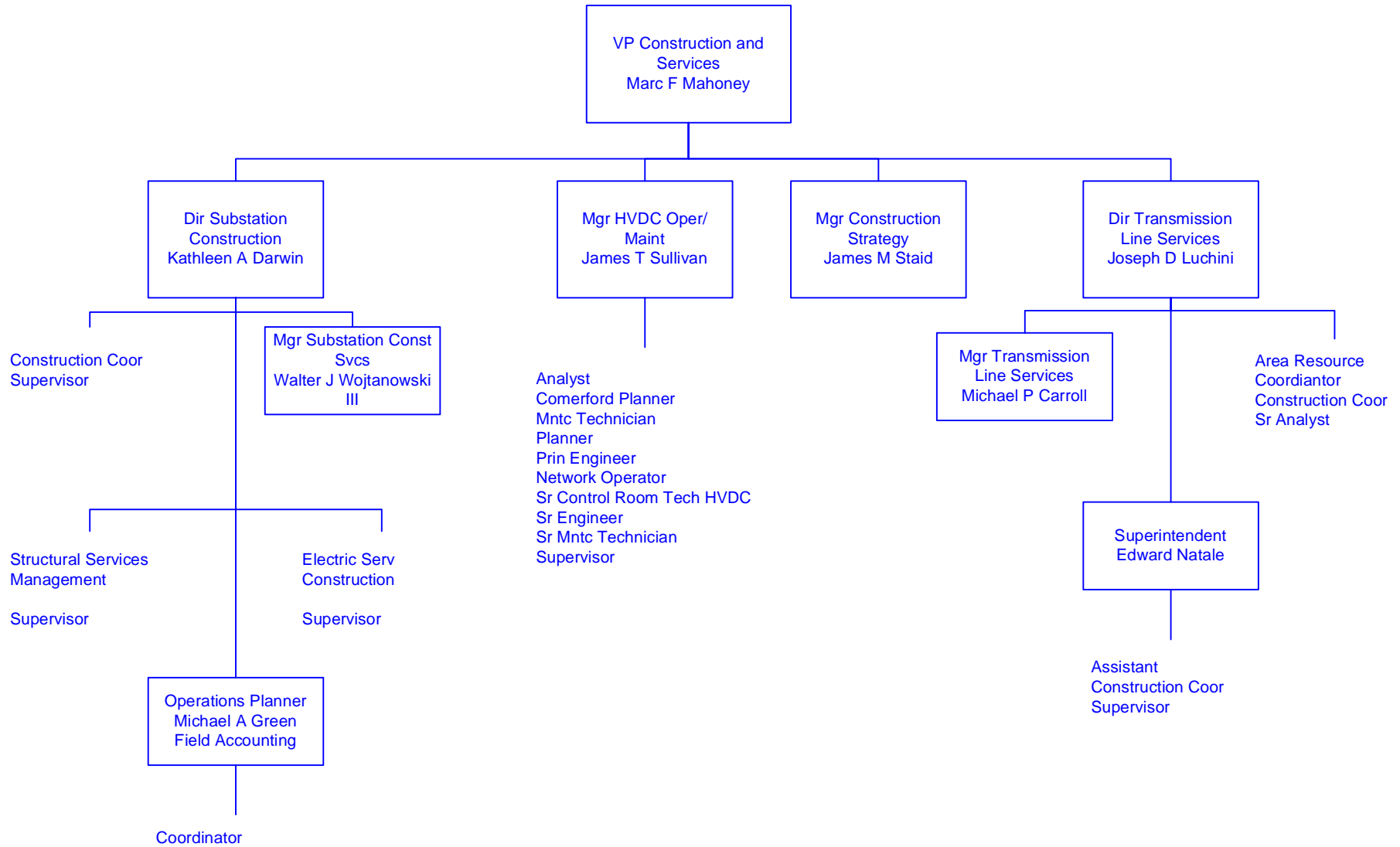

All employees shown on this page are employed by National Grid USA Service Co.  
Information shown in blue represents a Transmission Function

Last Updated 01/16/07

# Transmission Regulation and Commercial

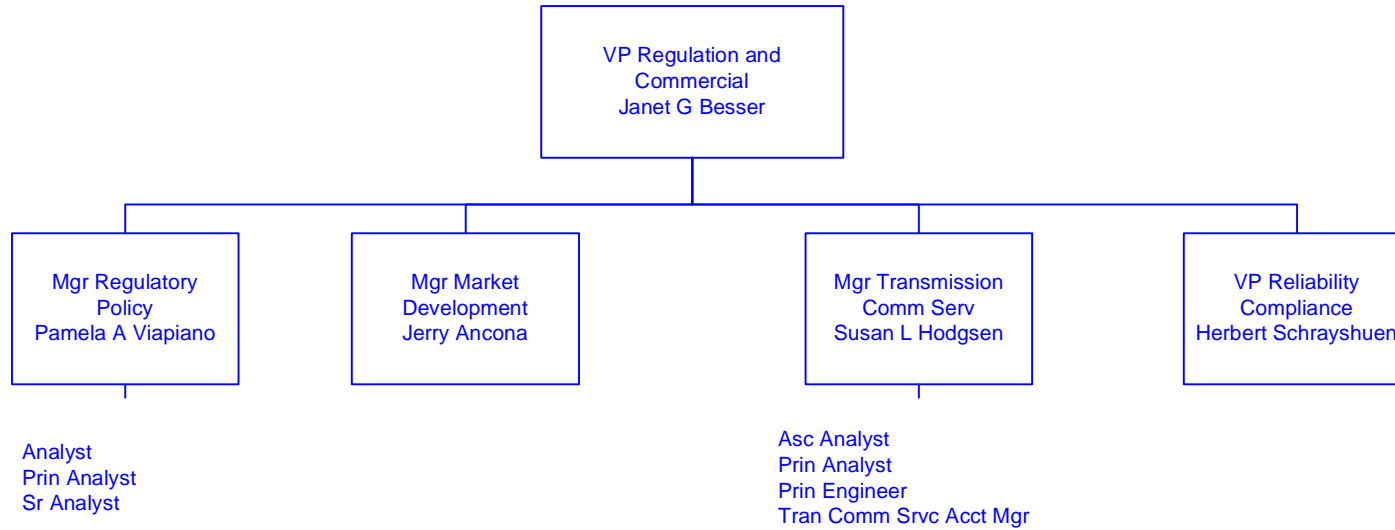

All employees shown on this page are employed by National Grid USA Service Co.  
Information shown in blue represents a Transmission Function

Last Updated 12/11/06

# Transmission Network Operations

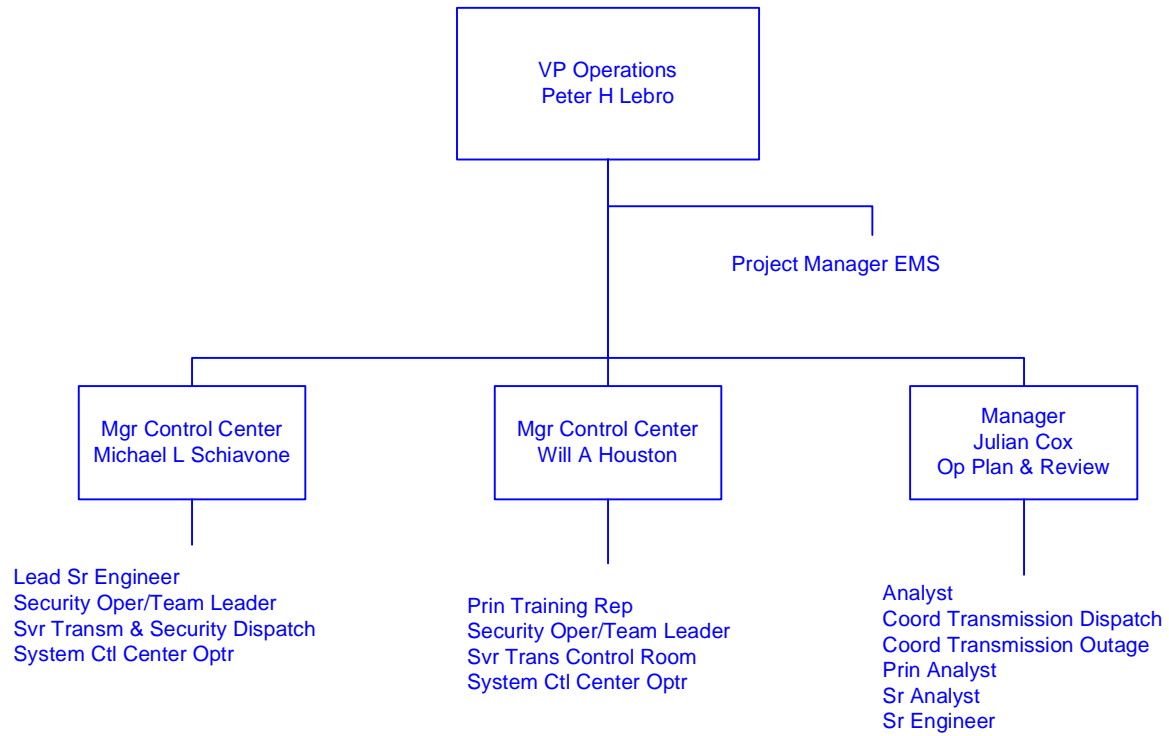

All employees shown on this page are employed by National Grid USA Service Co.  
Information shown in blue represents a Transmission Function

Last Updated 12/11/06

# Transmission Finance

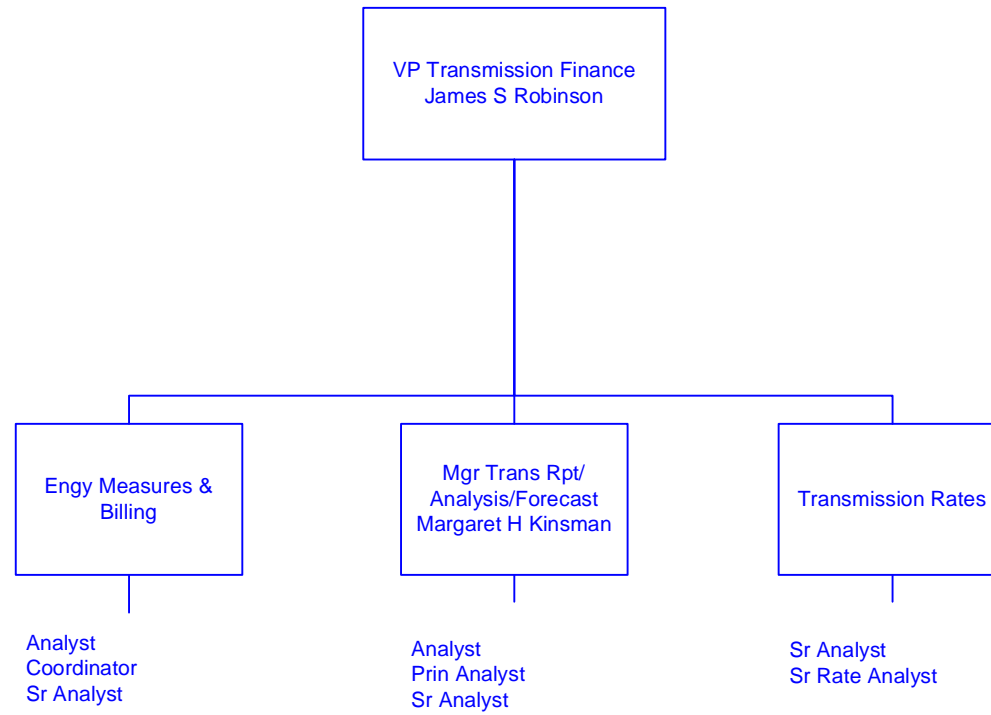

All employees shown on this page are employed by National Grid USA Service Co.  
Information shown in blue represents a Transmission Function

Last Updated 02/05/07

# Transmission Asset Management

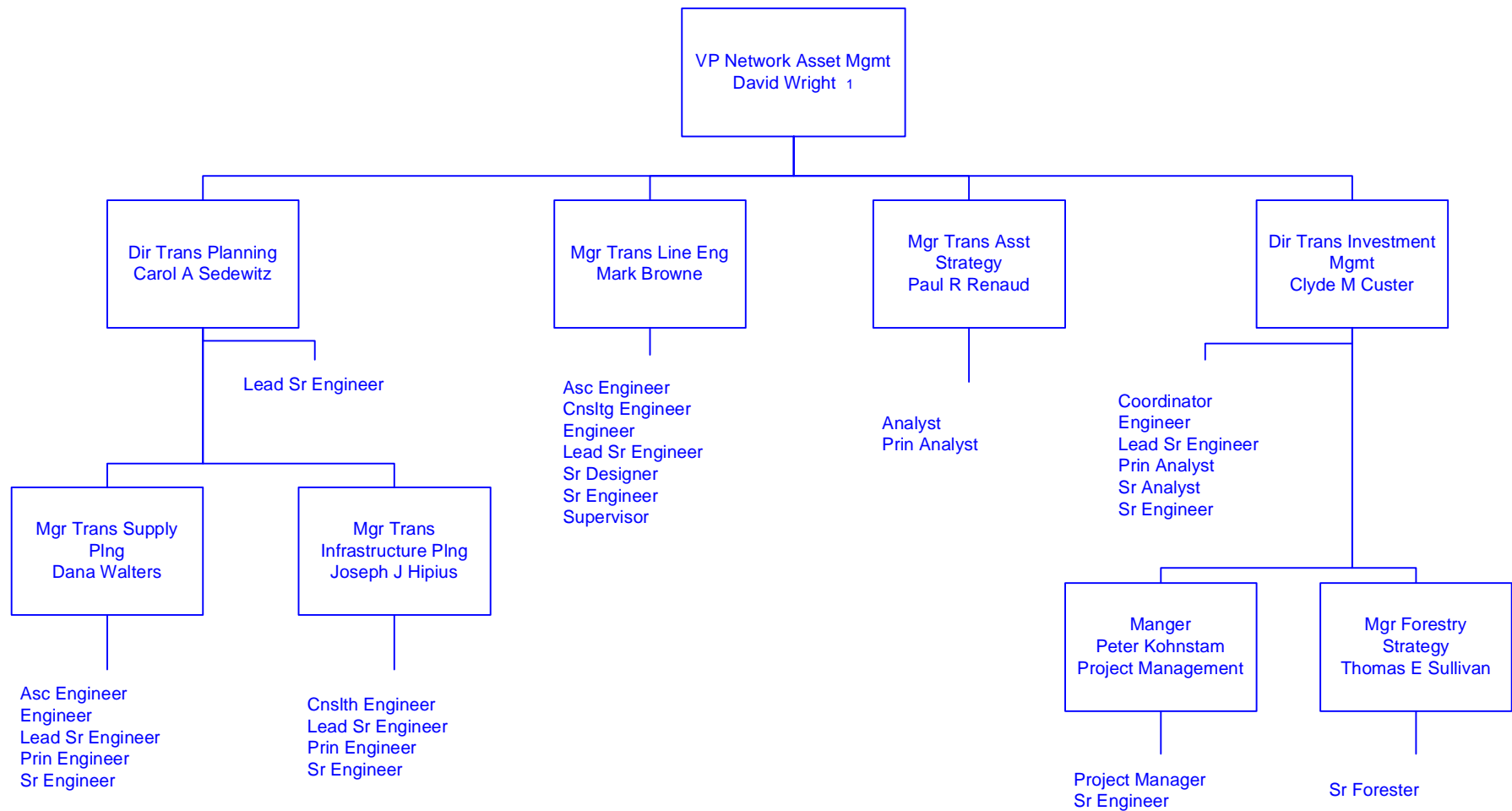

All employees shown on this page are employed by National Grid USA Service Co.  
Information shown in blue represents a Transmission Function

Last Updated 11/01/06

National Grid USA

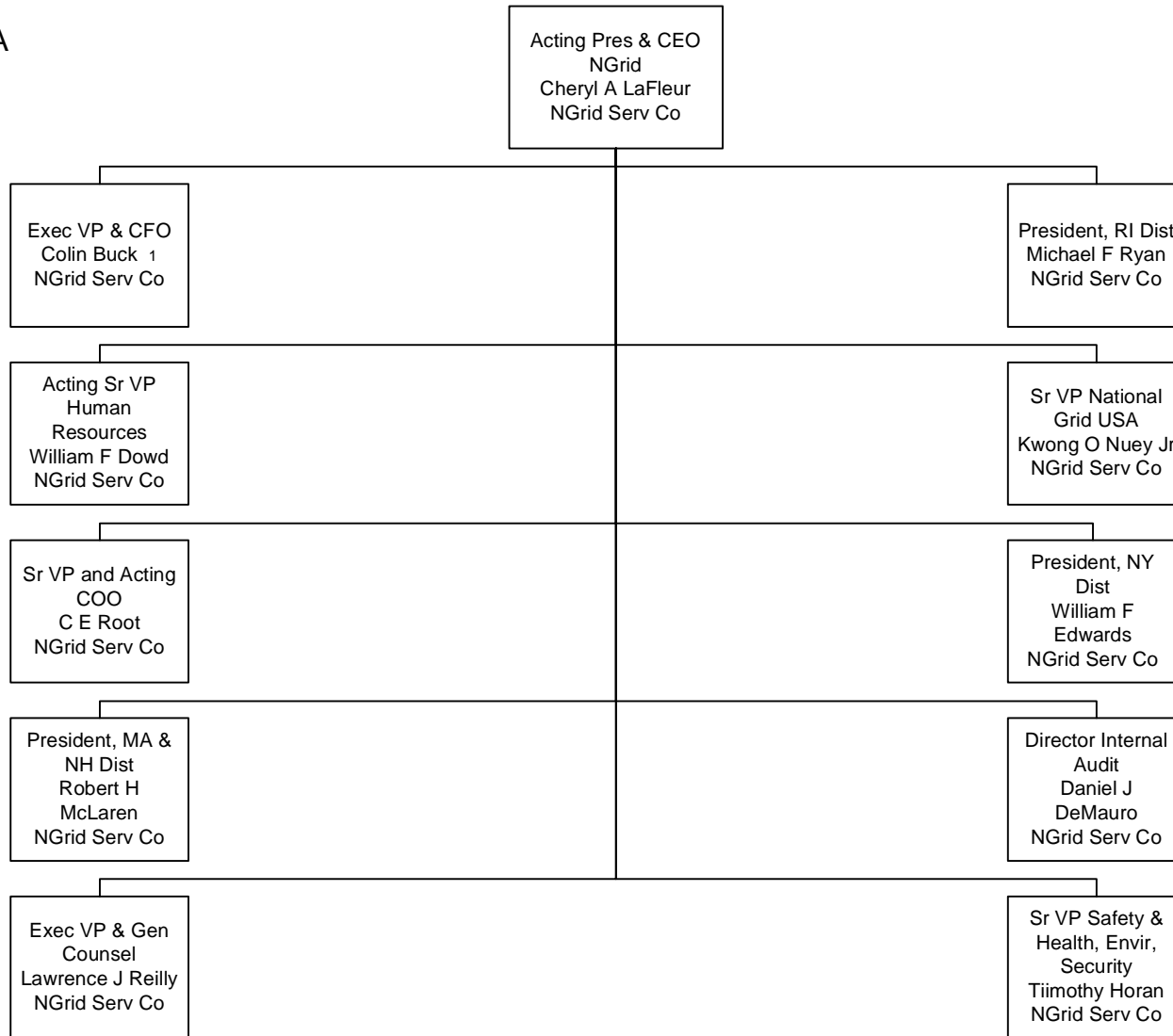

GECO = Granite State Electric Company  
 MECO = Massachusetts Electric Company  
 Nant = Nantucket Electric Company  
 NECO = The Narragansett Electric Company  
 NECO Gas = Narragansett Electric Company  
 NGrid Serv Co = National Grid USA Service Company Inc  
 NIMO = Niagara Mohawk Power Corporation  
 Information shown in Blue represents a Transmission Function  
 Information shown in Red represents a Sales & Marketing Function

# Business Service MA and NH

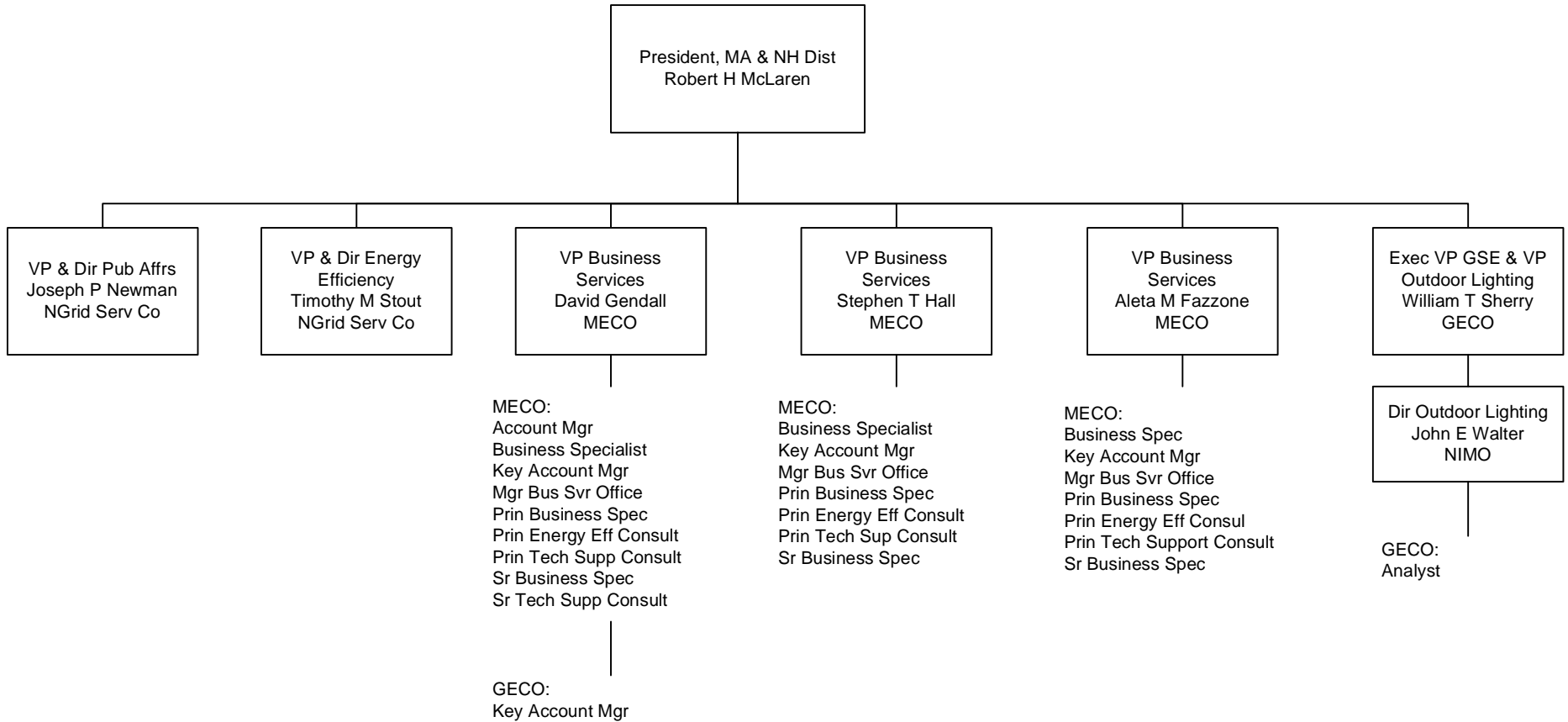

GECO = Granite State Electric Company  
 MECO = Massachusetts Electric Company  
 Nant = Nantucket Electric Company  
 NECO = The Narragansett Electric Company  
 NECO Gas = Narragansett Electric Company  
 NGrid Serv Co = National Grid USA Service Company Inc  
 NIMO = Niagara Mohawk Power Corporation  
 Information shown in Blue represents a Transmission Function  
 Information shown in Red represents a Sales & Marketing Function



# Business Service RI

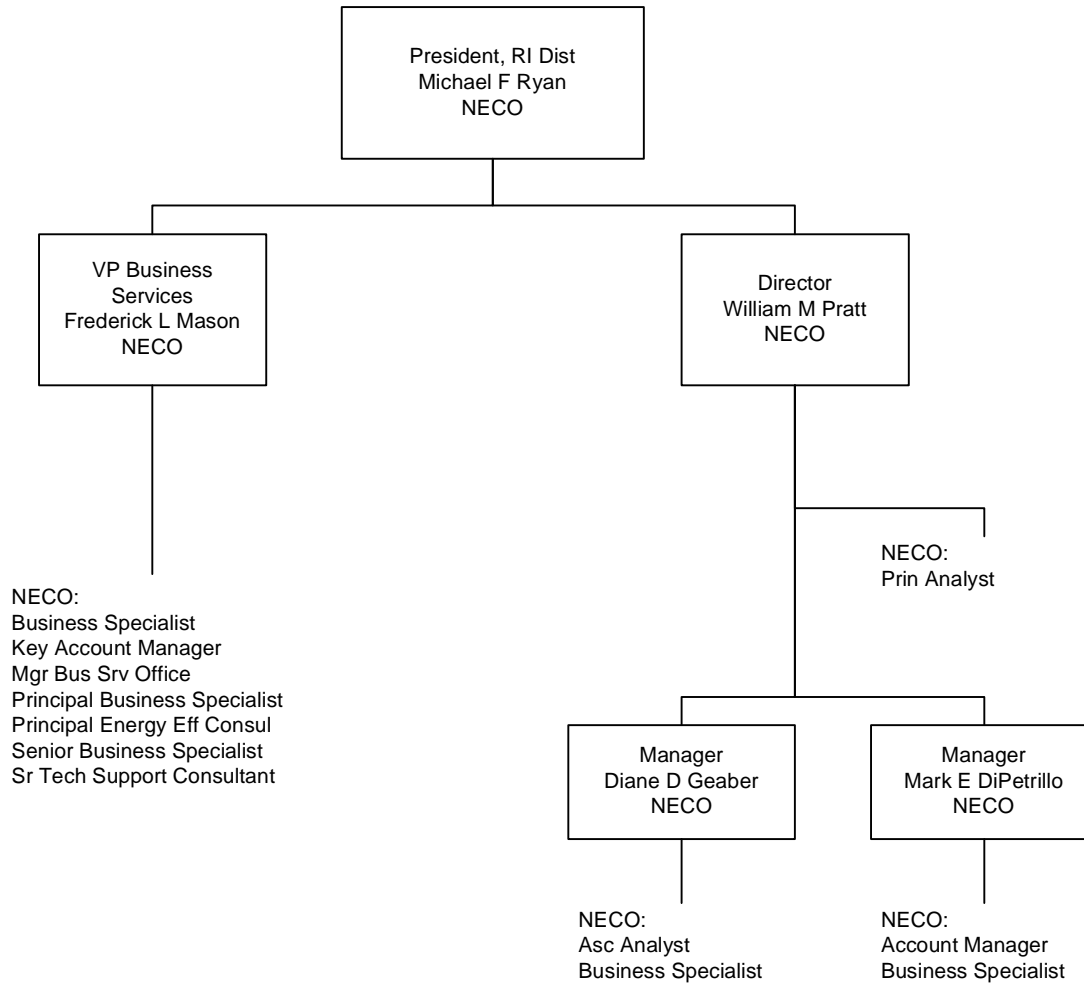

GECO = Granite State Electric Company  
 MECO = Massachusetts Electric Company  
 Nant = Nantucket Electric Company  
 NECO = The Narragansett Electric Company  
 NECO Gas = Narragansett Electric Company  
 NGrid Serv Co = National Grid USA Service Company Inc  
 NIMO = Niagara Mohawk Power Corporation  
 Information shown in Blue represents a Transmission Function  
 Information shown in Red represents a Sales & Marketing Function

# Operations

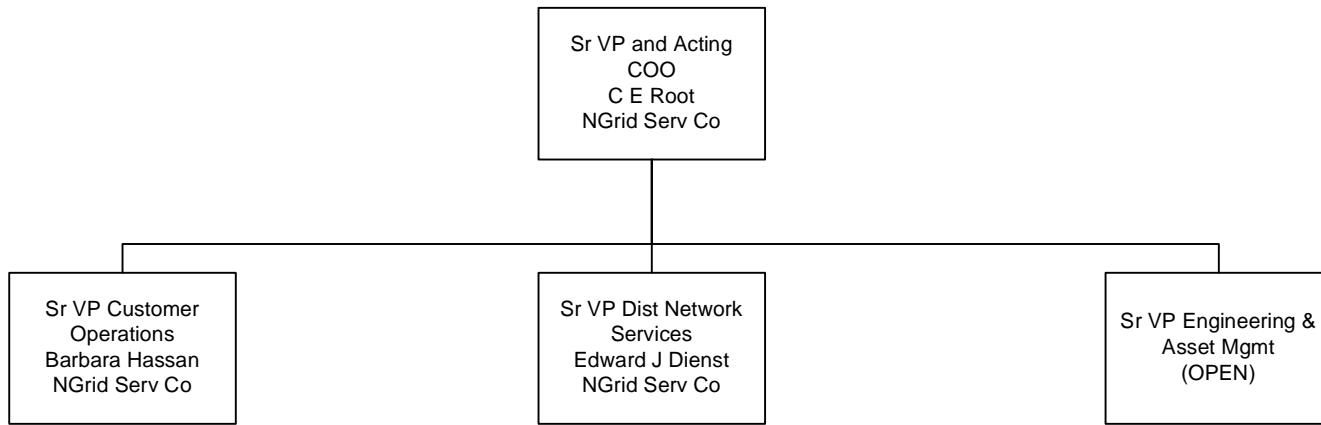

GECO = Granite State Electric Company  
MECO = Massachusetts Electric Company  
Nant = Nantucket Electric Company  
NECO = The Narragansett Electric Company  
NECO Gas = Narragansett Electric Company  
NGrid Serv Co = National Grid USA Service Company Inc  
NIMO = Niagara Mohawk Power Corporation  
Information shown in Blue represents a Transmission Function  
Information shown in Red represents a Sales & Marketing Function

## Distribution Operations

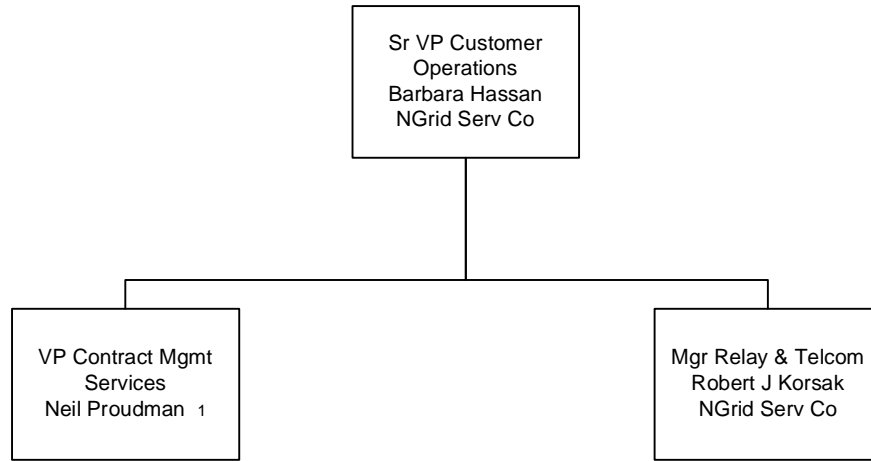

GECO = Granite State Electric Company

MECO = Massachusetts Electric Company

Nant = Nantucket Electric Company

NECO = The Narragansett Electric Company

NECO Gas = Narragansett Electric Company

NGrid Serv Co = National Grid USA Service Company Inc

NIMO = Niagara Mohawk Power Corporation

Information shown in Blue represents a Transmission Function

Information shown in Red represents a Sales & Marketing Function

# Distribution Network Services

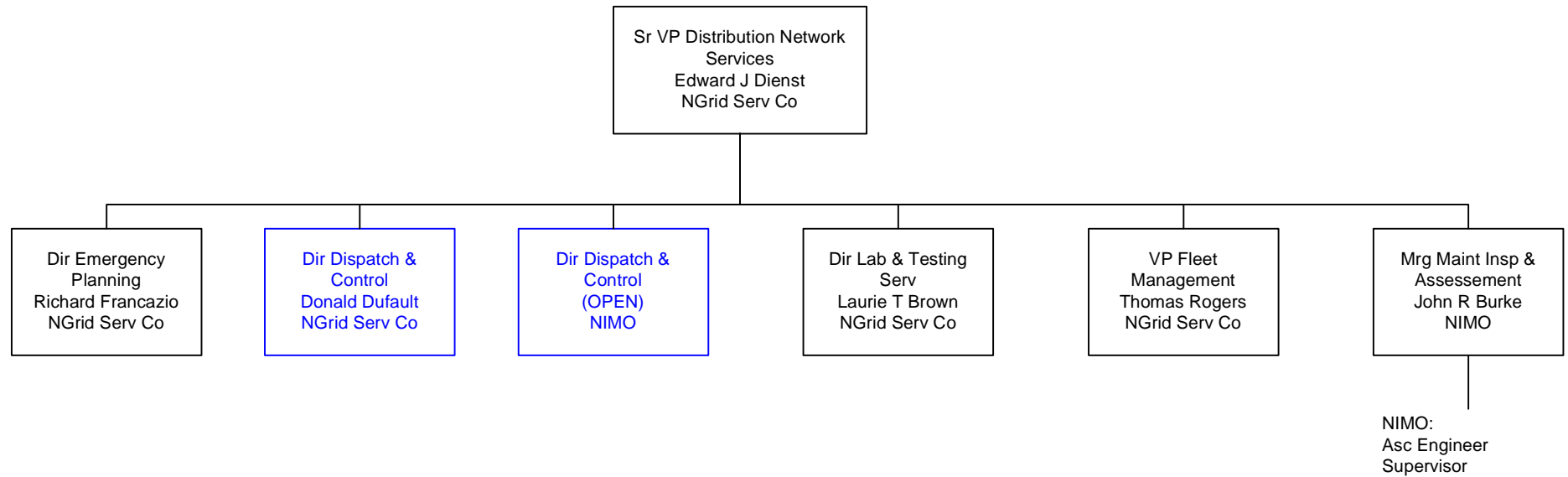

GECO = Granite State Electric Company  
 MECO = Massachusetts Electric Company  
 Nant = Nantucket Electric Company  
 NECO = The Narragansett Electric Company  
 NECO Gas = Narragansett Electric Company  
 NGrid Serv Co = National Grid USA Service Company Inc  
 NIMO = Niagara Mohawk Power Corporation  
 Information shown in Blue represents a Transmission Function  
 Information shown in Red represents a Sales & Marketing Function

# New England Distribution Dispatch and Control

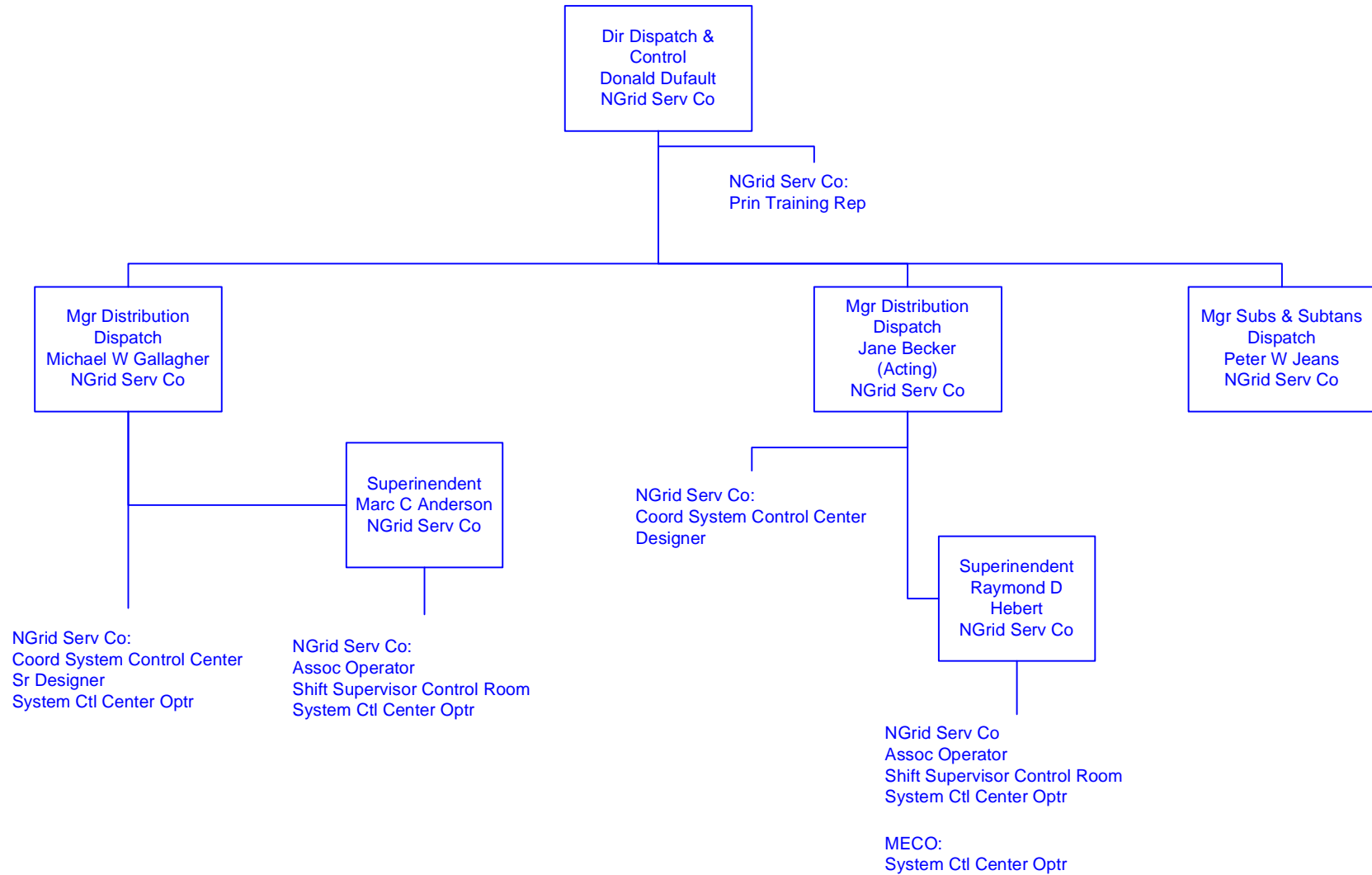

GECO = Granite State Electric Company  
 MECO = Massachusetts Electric Company  
 Nant = Nantucket Electric Company  
 NECO = The Narragansett Electric Company  
 NECO Gas = Narragansett Electric Company  
 NGrid Serv Co = National Grid USA Service Company Inc  
 NIMO = Niagara Mohawk Power Corporation  
 Information shown in Blue represents a Transmission Function  
 Information shown in Red represents a Sales & Marketing Function

# New York Distribution Dispatch and Control

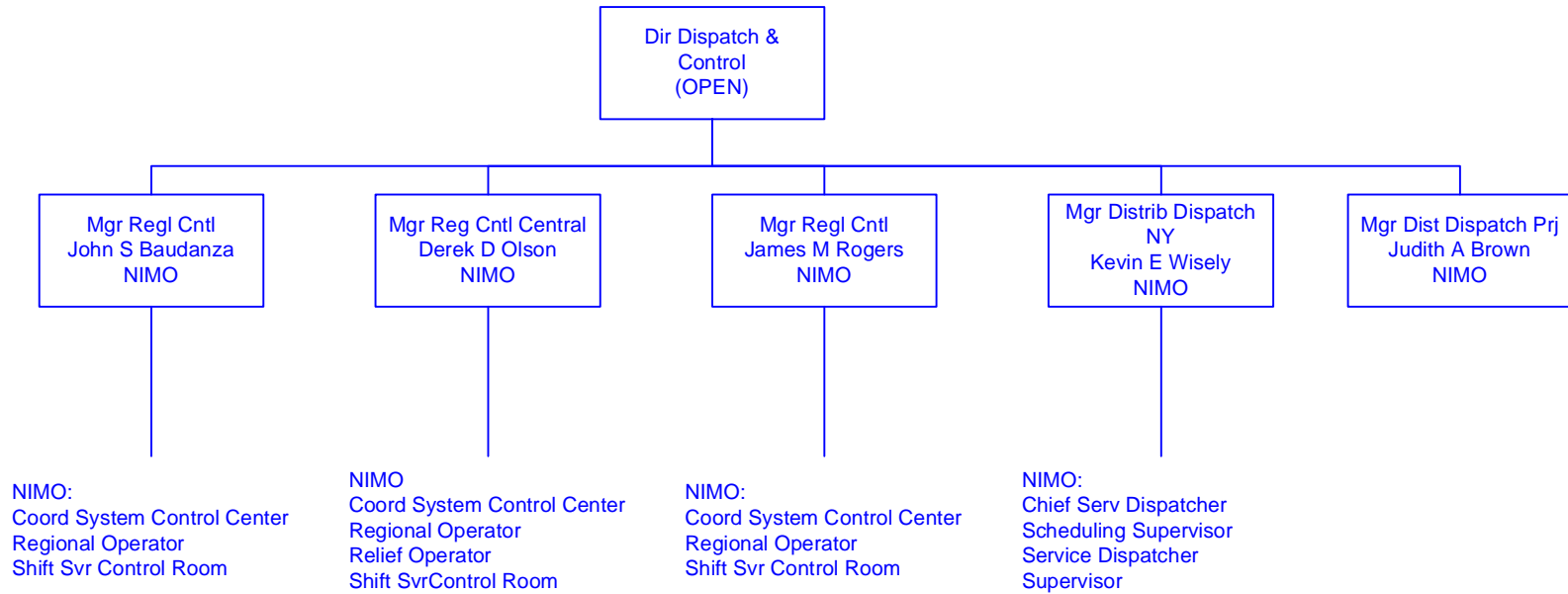

GECCO = Granite State Electric Company  
 MECO = Massachusetts Electric Company  
 Nant = Nantucket Electric Company  
 NECO = The Narragansett Electric Company  
 NECO Gas = Narragansett Electric Company  
 NGrid Serv Co = National Grid USA Service Company Inc  
 NIMO = Niagara Mohawk Power Corporation  
 Information shown in Blue represents a Transmission Function  
 Information shown in Red represents a Sales & Marketing Function

## Lab and Testing Services

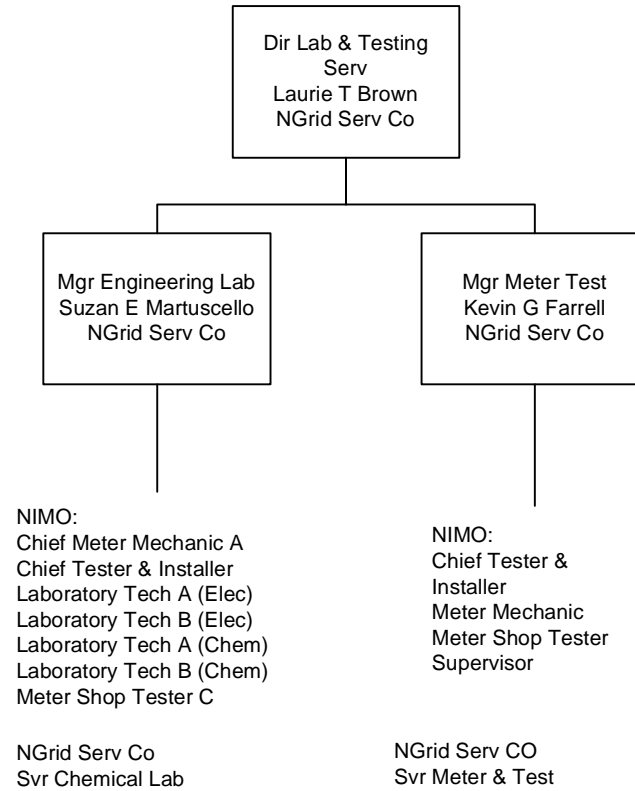

GECO = Granite State Electric Company

MECO = Massachusetts Electric Company

Nant = Nantucket Electric Company

NECO = The Narragansett Electric Company

NECO Gas = Narragansett Electric Company

NGrid Serv Co = National Grid USA Service Company Inc

NIMO = Niagara Mohawk Power Corporation

Information shown in Blue represents a Transmission Function

Information shown in Red represents a Sales & Marketing Function

Last Updated 11/01/06

# Fleet Management

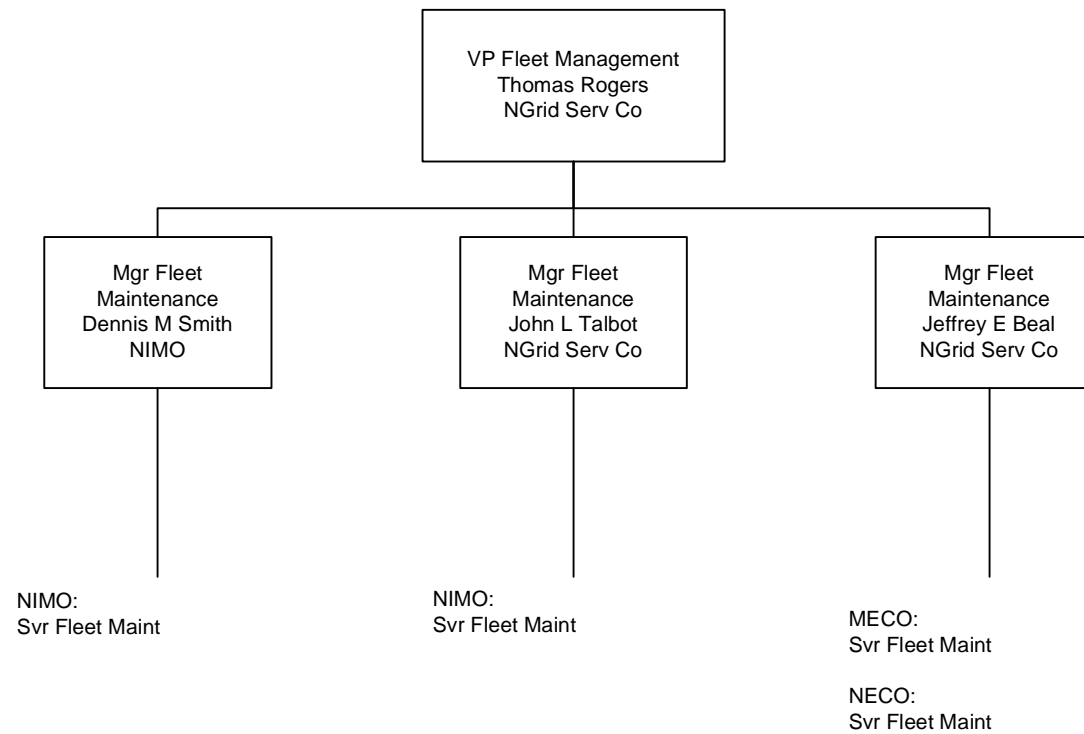

GECO = Granite State Electric Company  
MECO = Massachusetts Electric Company  
Nant = Nantucket Electric Company  
NECO = The Narragansett Electric Company  
NECO Gas = Narragansett Electric Company  
NGrid Serv Co = National Grid USA Service Company Inc  
NIMO = Niagara Mohawk Power Corporation  
Information shown in Blue represents a Transmission Function  
Information shown in Red represents a Sales & Marketing Function

Last Updated 11/01/06



## Engineering and Asset Management

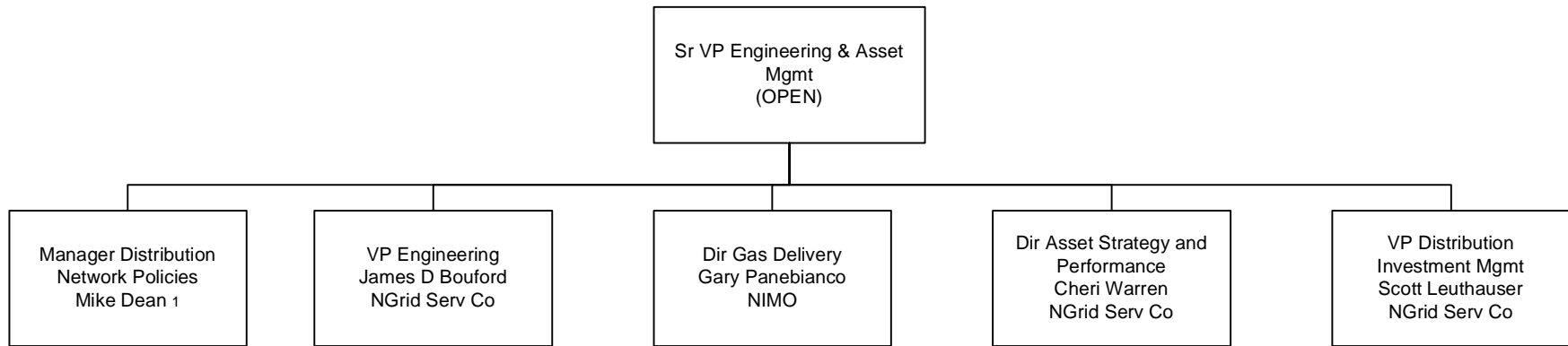

GECO = Granite State Electric Company

MECO = Massachusetts Electric Company

Nant = Nantucket Electric Company

NECO = The Narragansett Electric Company

NECO Gas = Narragansett Electric Company

NGrid Serv Co = National Grid USA Service Company Inc

NIMO = Niagara Mohawk Power Corporation

Information shown in Blue represents a Transmission Function

Information shown in Red represents a Sales & Marketing Function

# Engineering Services

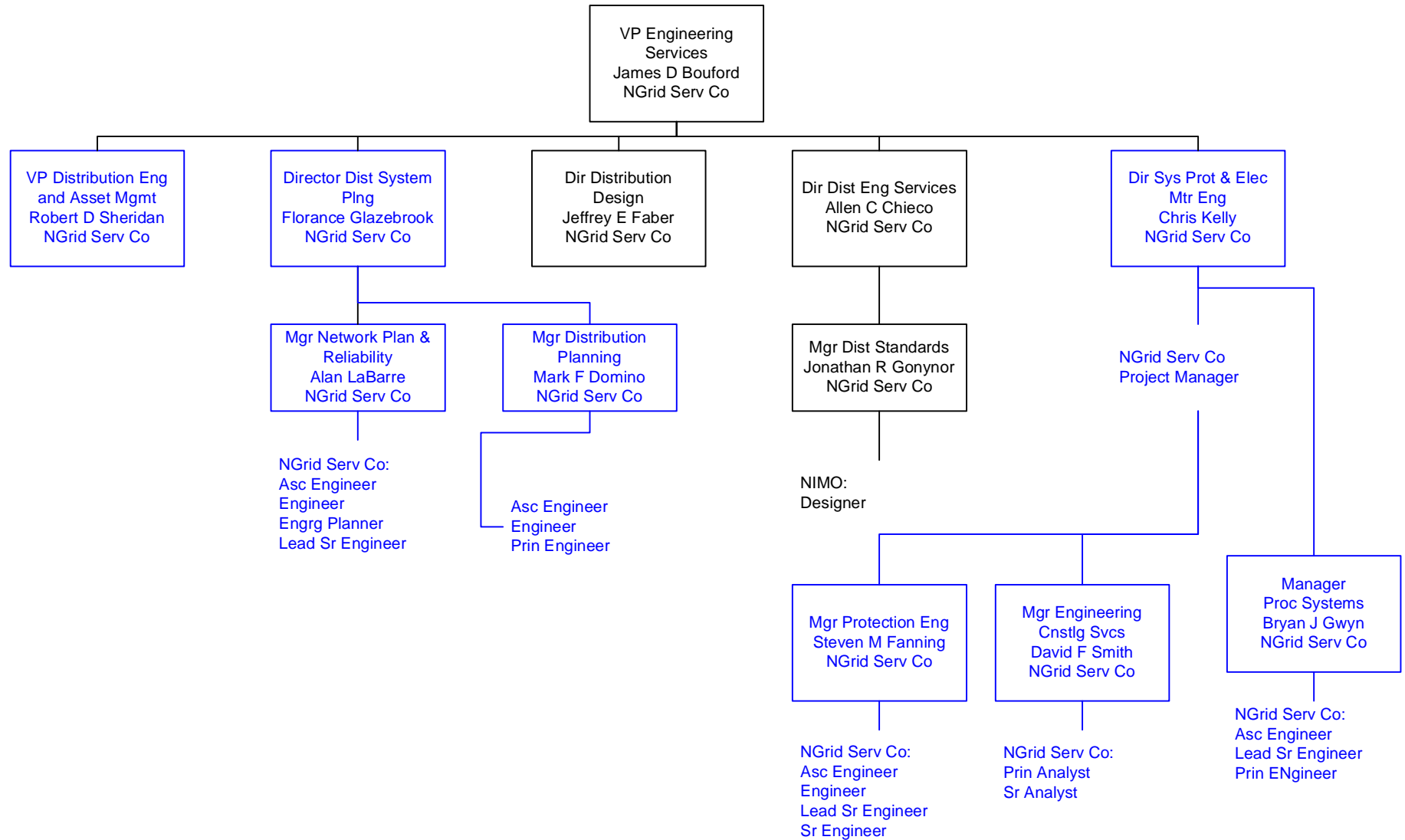

GECS = Granite State Electric Company  
 MECO = Massachusetts Electric Company  
 Nant = Nantucket Electric Company  
 NECO = The Narragansett Electric Company  
 NECO Gas = Narragansett Electric Company  
 NGrid Serv Co = National Grid USA Service Company Inc  
 NIMO = Niagara Mohawk Power Corporation  
 Information shown in Blue represents a Transmission Function  
 Information shown in Red represents a Sales & Marketing Function

Engineering Services Cont.

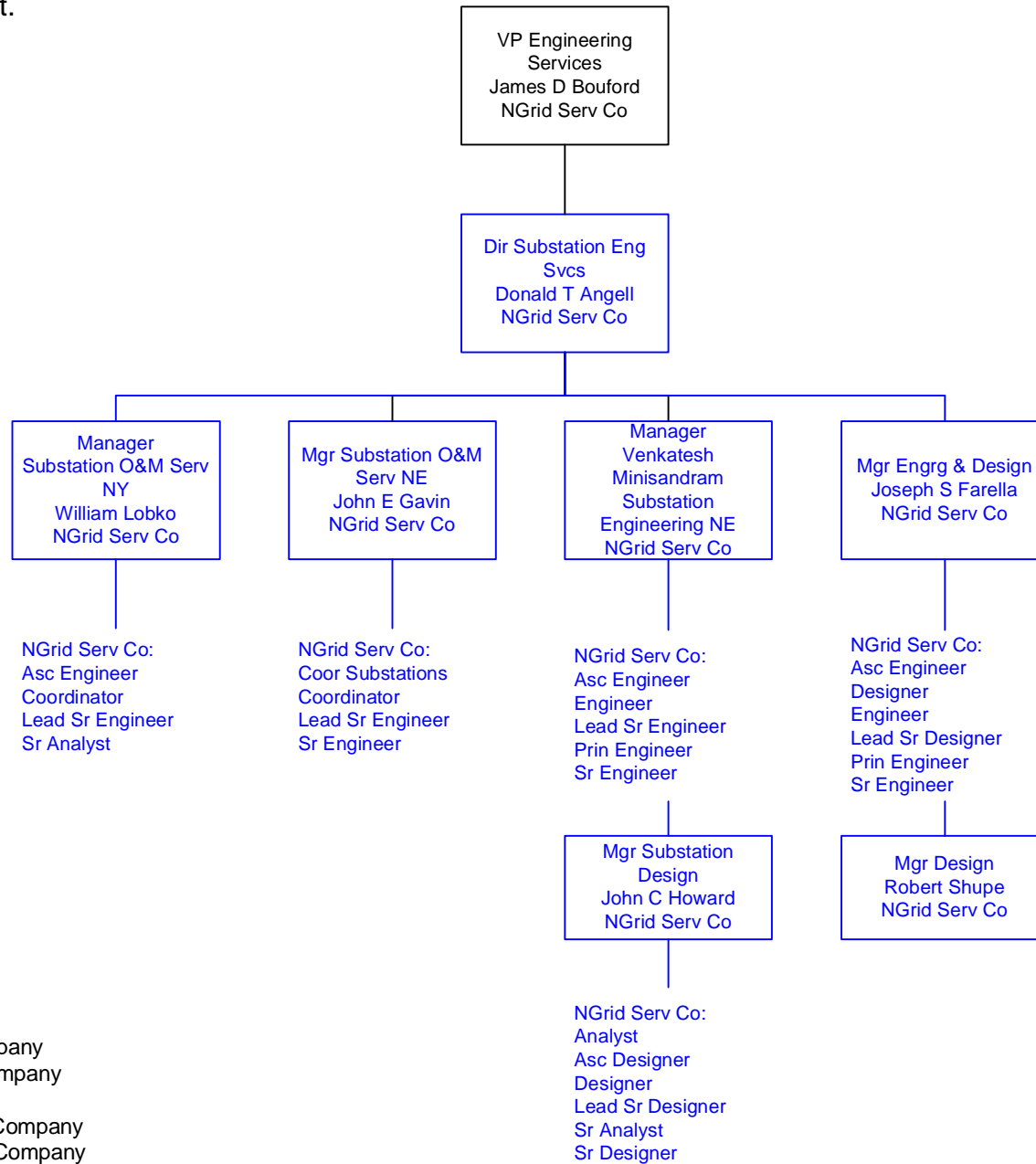

GECS = Granite State Electric Company  
 MECO = Massachusetts Electric Company  
 Nant = Nantucket Electric Company  
 NECO = The Narragansett Electric Company  
 NECO Gas = Narragansett Electric Company  
 NGrid Serv Co = National Grid USA Service Company Inc  
 NIMO = Niagara Mohawk Power Corporation  
 Information shown in Blue represents a Transmission Function  
 Information shown in Red represents a Sales & Marketing Function

# Engineering and Asset Management

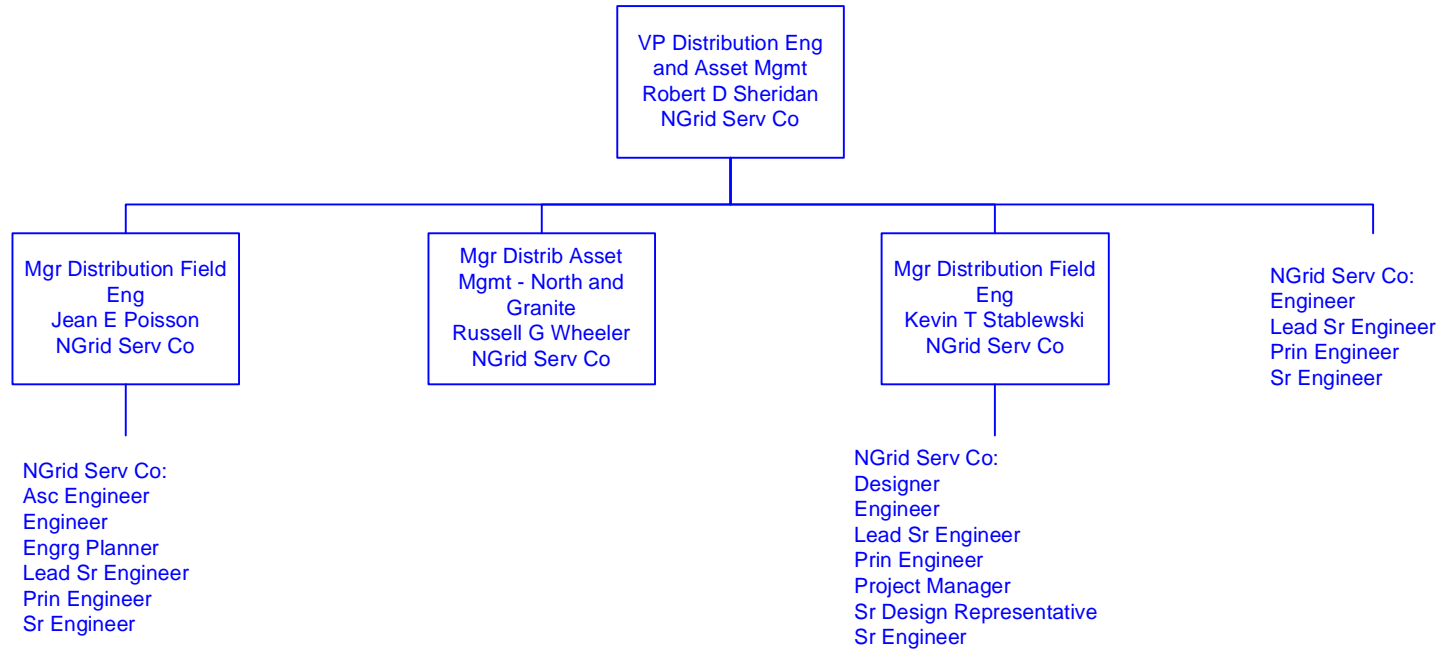

GECO = Granite State Electric Company  
 MECO = Massachusetts Electric Company  
 Nant = Nantucket Electric Company  
 NECO = The Narragansett Electric Company  
 NECO Gas = Narragansett Electric Company  
 NGrid Serv Co = National Grid USA Service Company Inc  
 NIMO = Niagara Mohawk Power Corporation  
 Information shown in Blue represents a Transmission Function  
 Information shown in Red represents a Sales & Marketing Function

# Gas Distribution

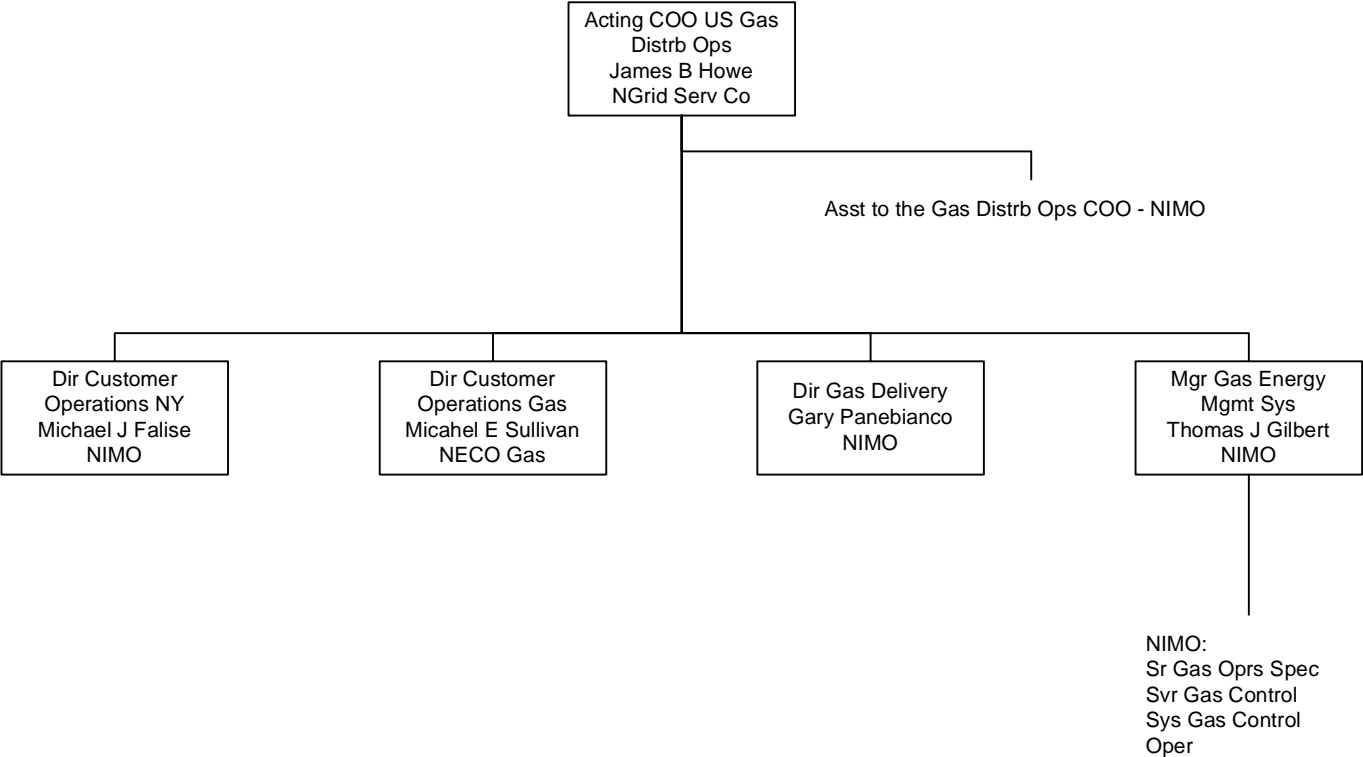

GECS = Granite State Electric Company  
 MECO = Massachusetts Electric Company  
 Nant = Nantucket Electric Company  
 NECO = The Narragansett Electric Company  
 NECO Gas = Narragansett Electric Company  
 NGrid Serv Co = National Grid USA Service Company Inc  
 NIMO = Niagara Mohawk Power Corporation  
 Information shown in Blue represents a Transmission Function  
 Information shown in Red represents a Sales & Marketing Function

# Gas Delivery

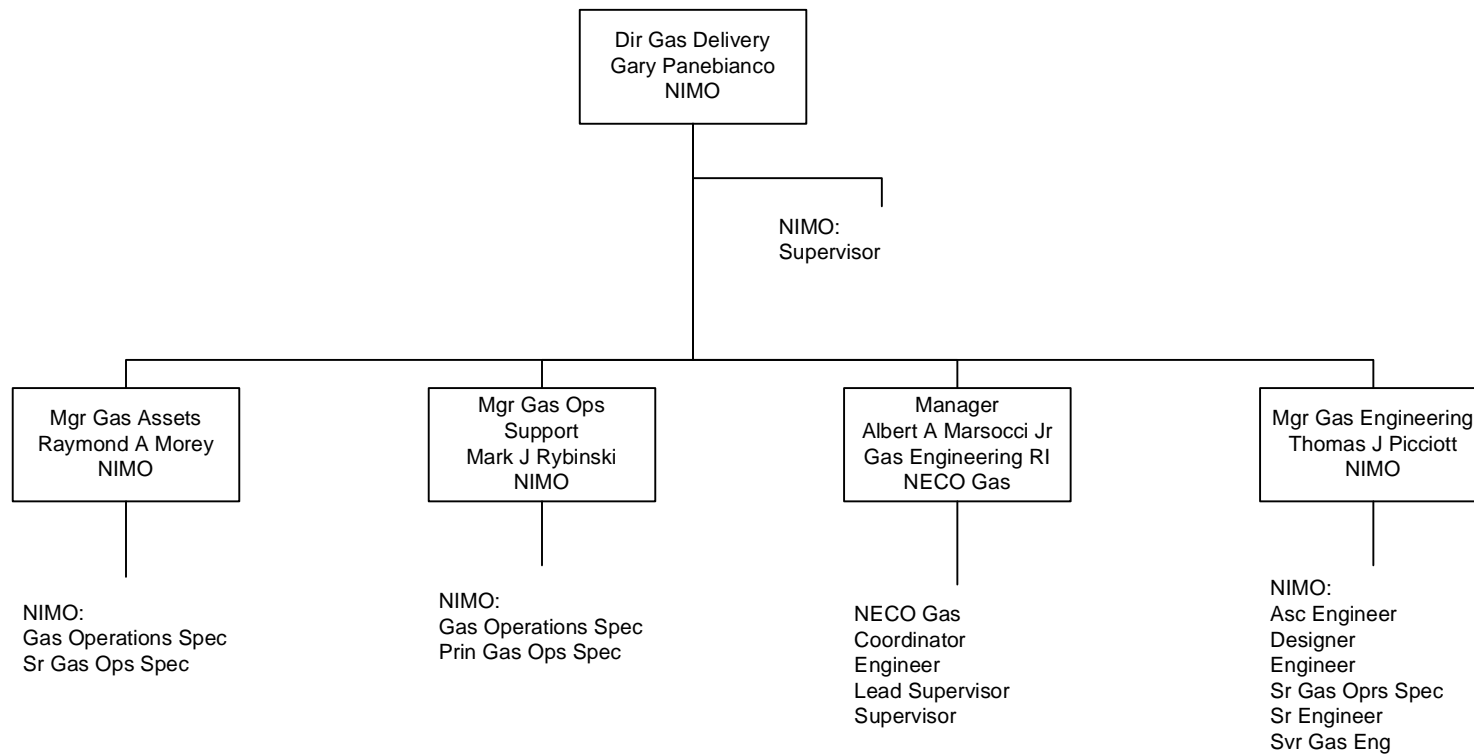

GECO = Granite State Electric Company  
 MECO = Massachusetts Electric Company  
 Nant = Nantucket Electric Company  
 NECO = The Narragansett Electric Company  
 NECO Gas = Narragansett Electric Company  
 NGrid Serv Co = National Grid USA Service Company Inc  
 NIMO = Niagara Mohawk Power Corporation  
 Information shown in Blue represents a Transmission Function  
 Information shown in Red represents a Sales & Marketing Function

# New York Distribution

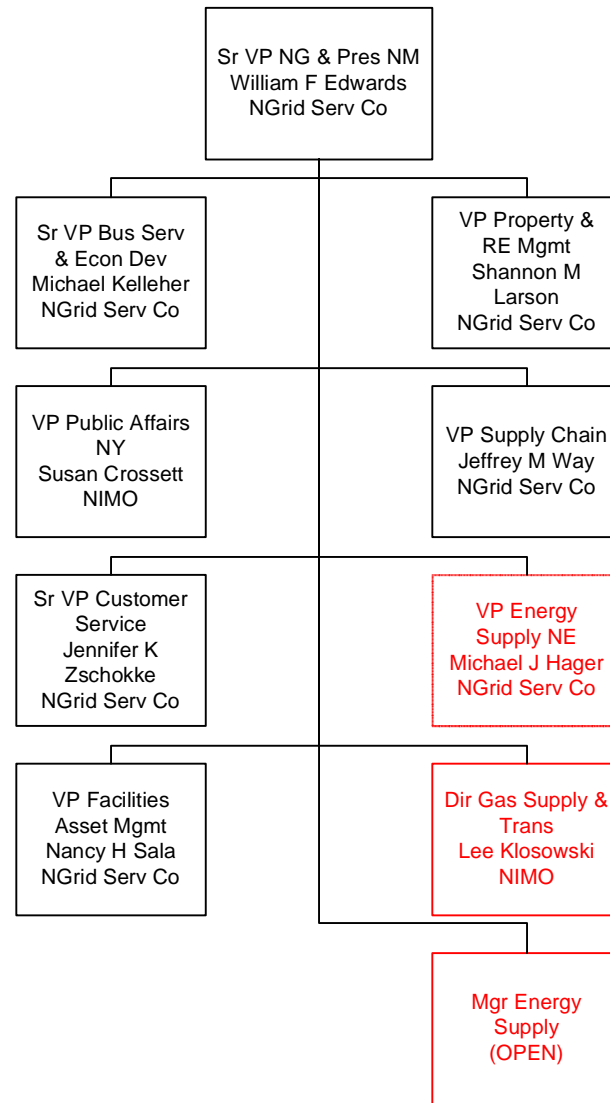

GECO = Granite State Electric Company  
 MECO = Massachusetts Electric Company  
 Nant = Nantucket Electric Company  
 NECO = The Narragansett Electric Company  
 NECO Gas = Narragansett Electric Company  
 NGrid Serv Co = National Grid USA Service Company Inc  
 NIMO = Niagara Mohawk Power Corporation  
 Information shown in Blue represents a Transmission Function  
 Information shown in Red represents a Sales & Marketing Function

# Energy Supply

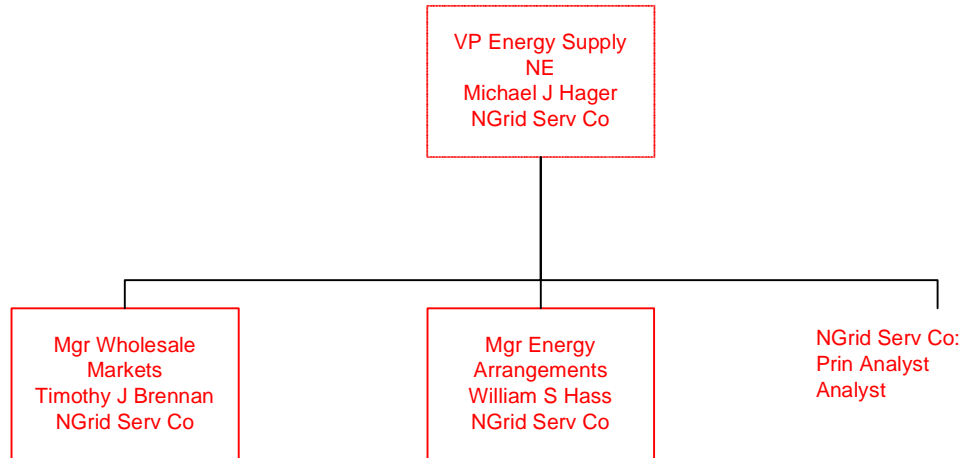

GECO = Granite State Electric Company

MECO = Massachusetts Electric Company

Nant = Nantucket Electric Company

NECO = The Narragansett Electric Company

NECO Gas = Narragansett Electric Company

NGrid Serv Co = National Grid USA Service Company Inc

NIMO = Niagara Mohawk Power Corporation

Information shown in Blue represents a Transmission Function

Information shown in Red represents a Sales & Marketing Function



# Gas and Energy Supply

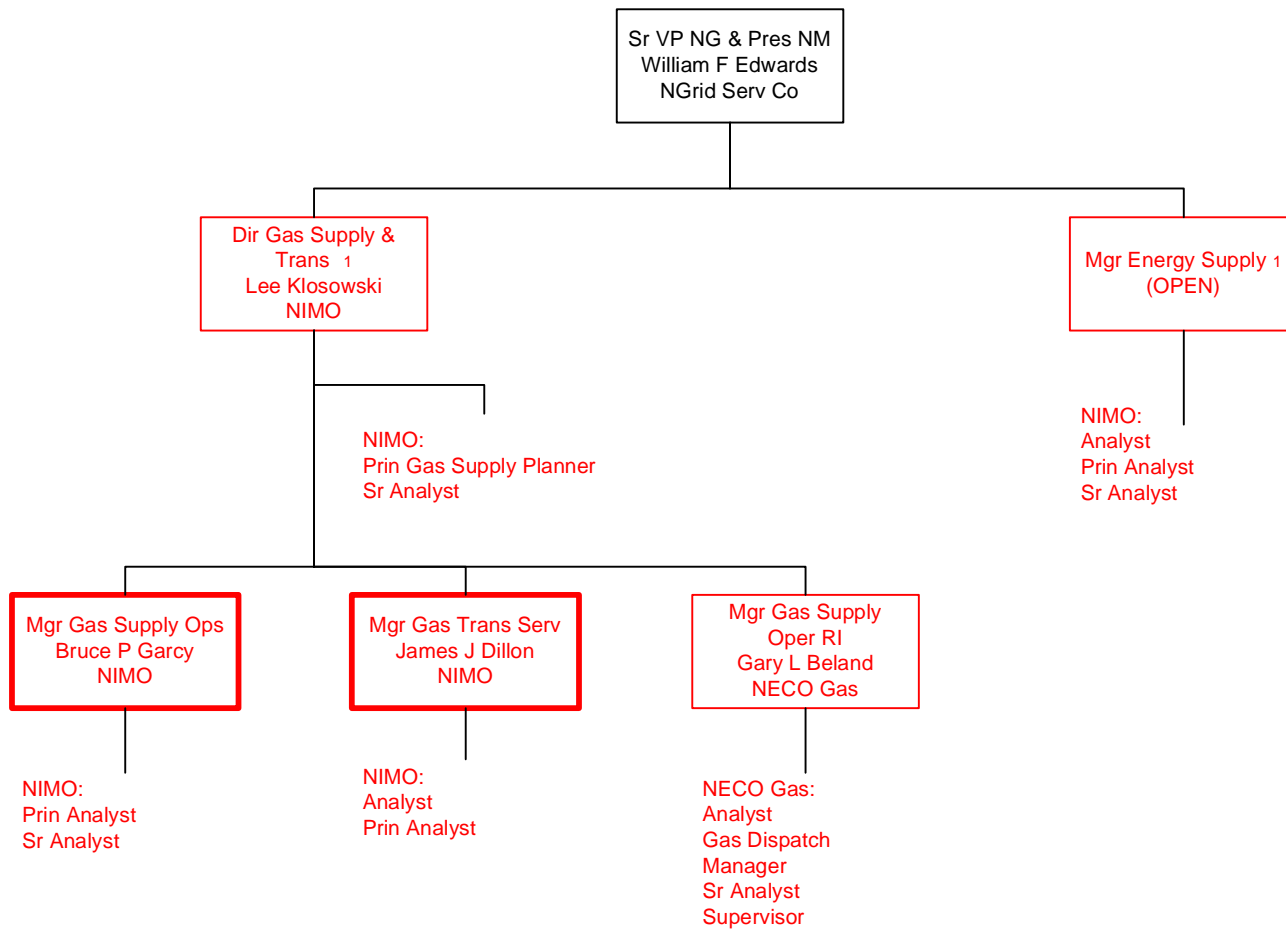

GECCO = Granite State Electric Company  
 MECO = Massachusetts Electric Company  
 Nant = Nantucket Electric Company  
 NECO = The Narragansett Electric Company  
 NECO Gas = Narragansett Electric Company  
 NGrid Serv Co = National Grid USA Service Company Inc  
 NIMO = Niagara Mohawk Power Corporation  
 Information shown in Blue represents a Transmission Function  
 Information shown in Red represents a Sales & Marketing Function

# Business Services and Economic Development

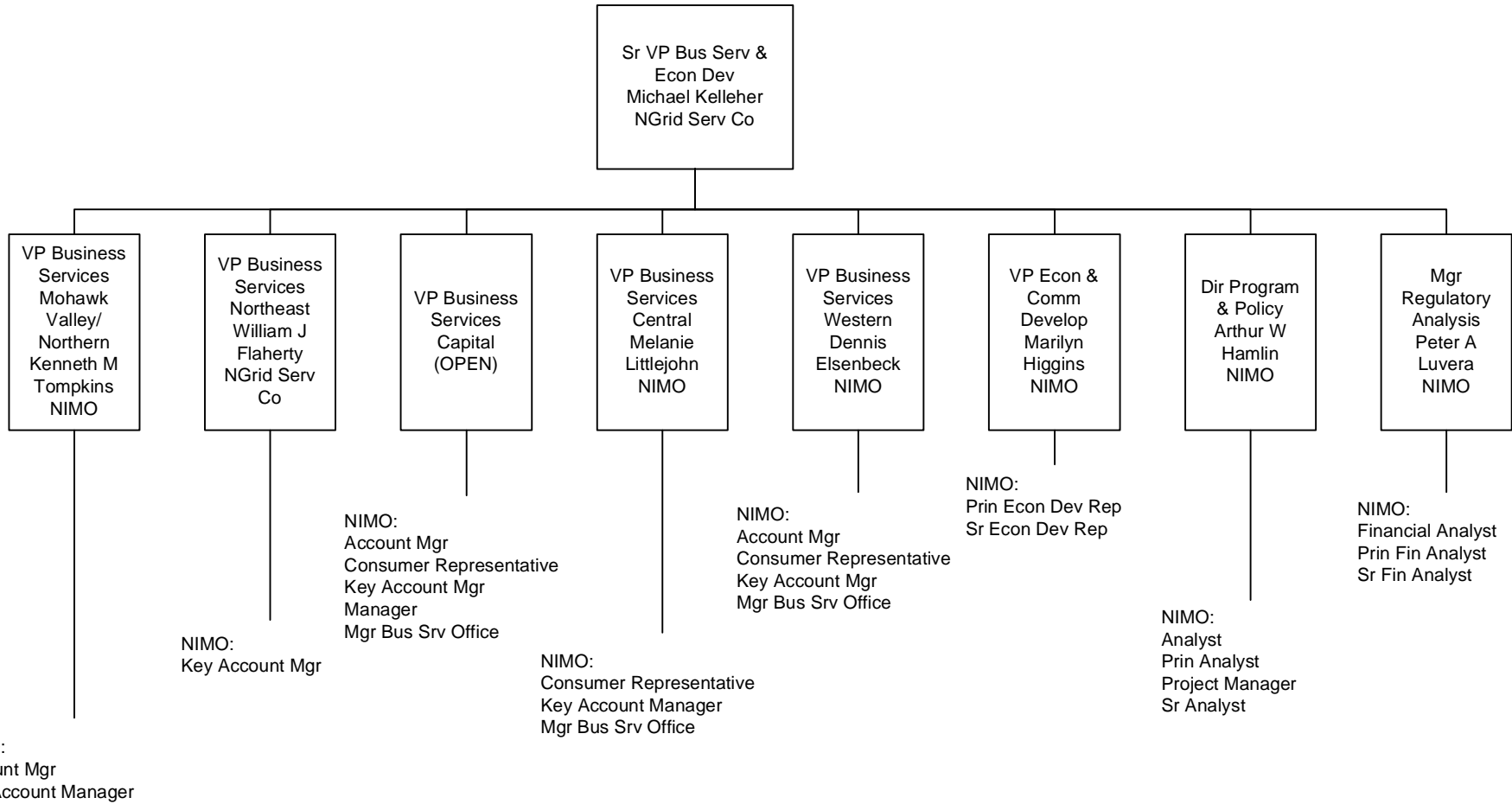

GECCO = Granite State Electric Company  
 MECO = Massachusetts Electric Company  
 Nant = Nantucket Electric Company  
 NECO = The Narragansett Electric Company  
 NECO Gas = Narragansett Electric Company  
 NGrid Serv Co = National Grid USA Service Company Inc  
 NIMO = Niagara Mohawk Power Corporation  
 Information shown in Blue represents a Transmission Function  
 Information shown in Red represents a Sales & Marketing Function

# Customer Service Centers

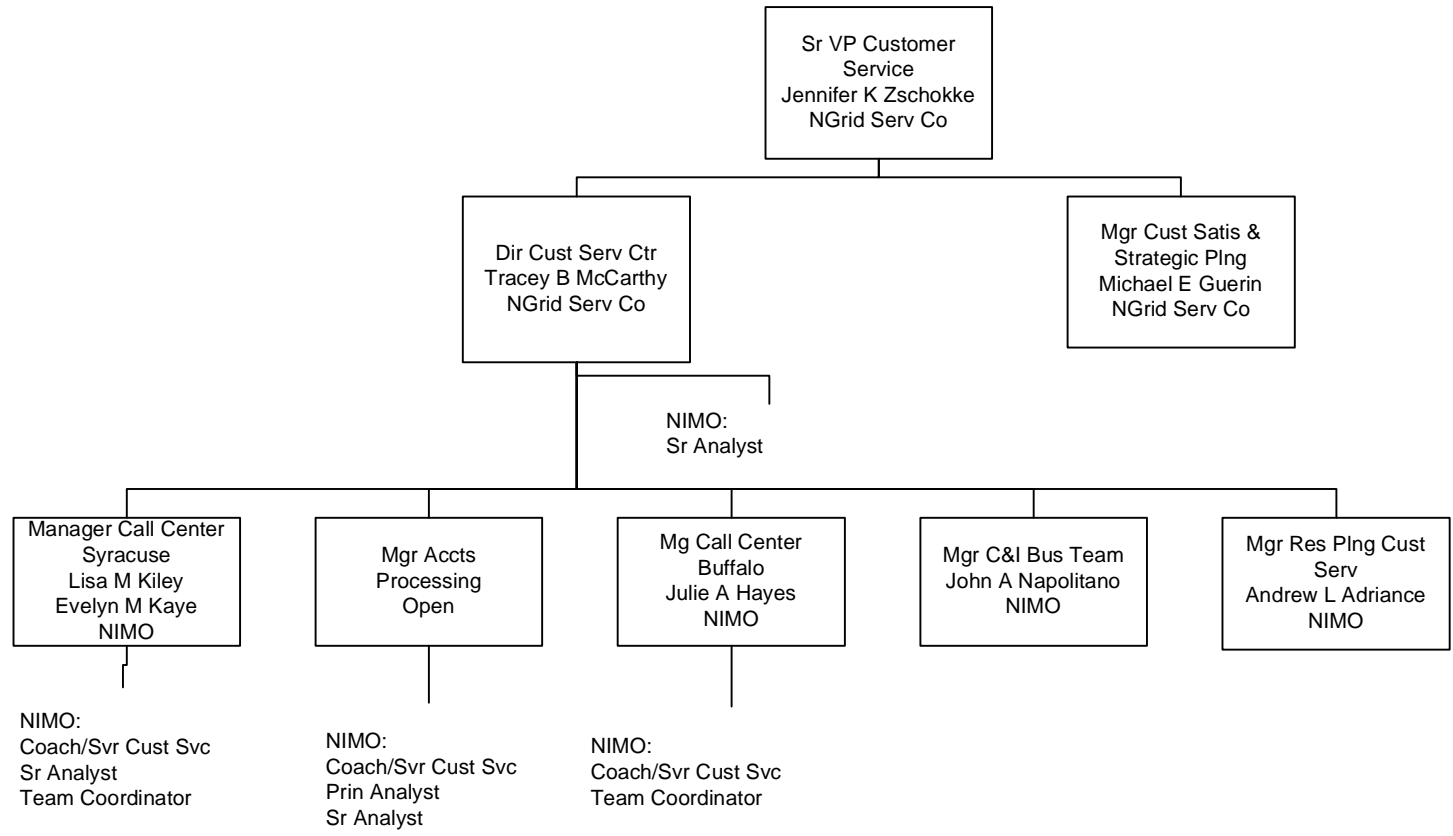

GECS = Granite State Electric Company  
 MECO = Massachusetts Electric Company  
 Nant = Nantucket Electric Company  
 NECO = The Narragansett Electric Company  
 NECO Gas = Narragansett Electric Company  
 NGrid Serv Co = National Grid USA Service Company Inc  
 NIMO = Niagara Mohawk Power Corporation  
 Information shown in Blue represents a Transmission Function  
 Information shown in Red represents a Sales & Marketing Function

# Customer Service Programs

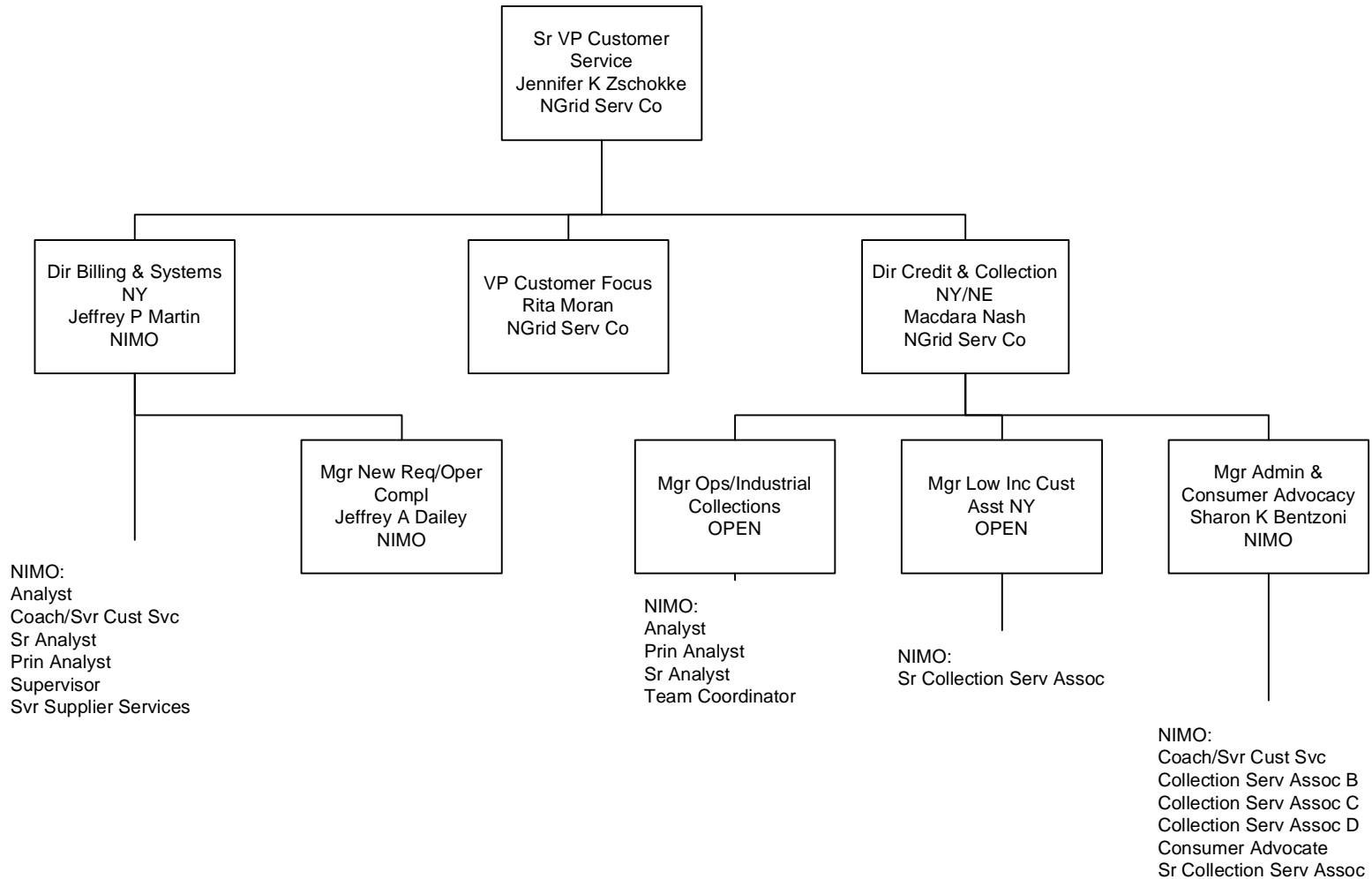

GECO = Granite State Electric Company  
 MECO = Massachusetts Electric Company  
 Nant = Nantucket Electric Company  
 NECO = The Narragansett Electric Company  
 NECO Gas = Narragansett Electric Company  
 NGrid Serv Co = National Grid USA Service Company Inc  
 NIMO = Niagara Mohawk Power Corporation  
 Information shown in Blue represents a Transmission Function  
 Information shown in Red represents a Sales & Marketing Function

Last Updated 01/09/07

## Customer Satisfaction and Strategic Planning and Support

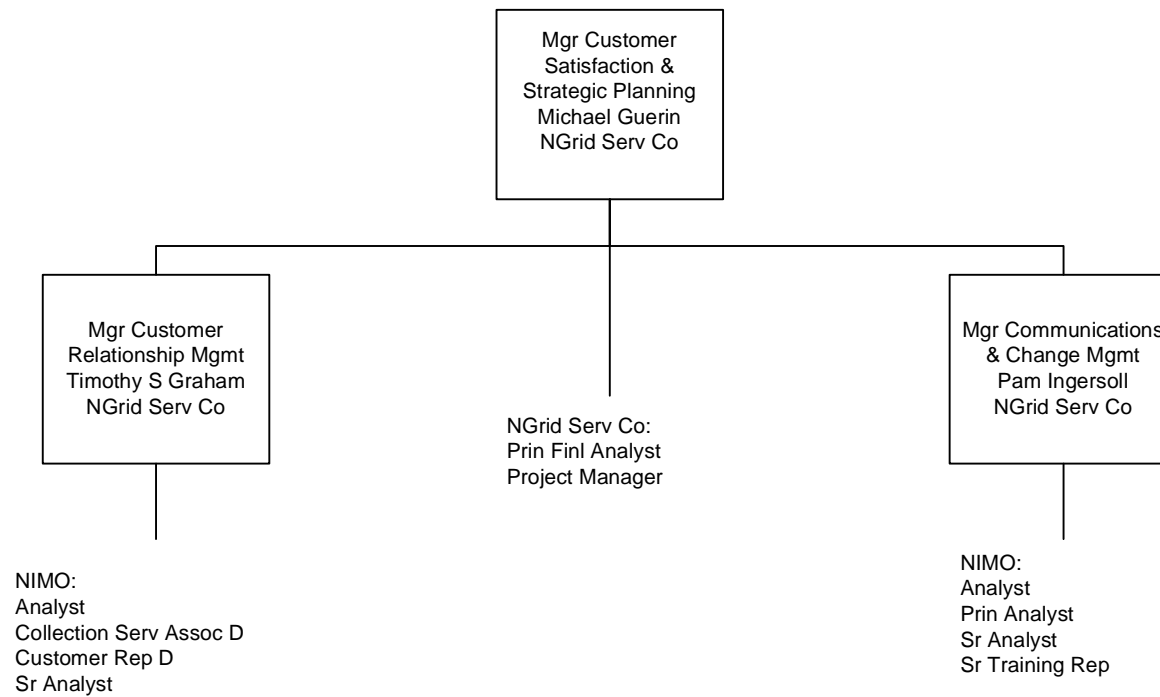

GECO = Granite State Electric Company

MECO = Massachusetts Electric Company

Nant = Nantucket Electric Company

NECO = The Narragansett Electric Company

NECO Gas = Narragansett Electric Company

NGrid Serv Co = National Grid USA Service Company Inc

NIMO = Niagara Mohawk Power Corporation

Information shown in Blue represents a Transmission Function

Information shown in Red represents a Sales & Marketing Function

# Supply Chain Management

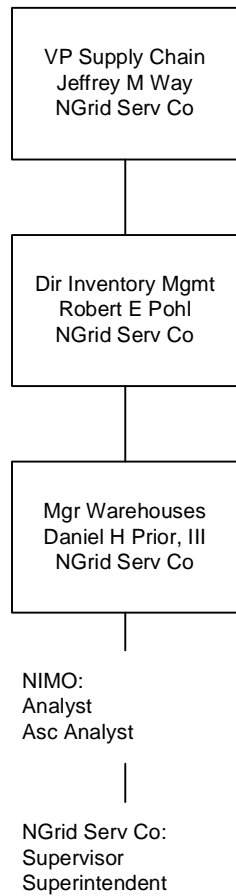

GECO = Granite State Electric Company  
MECO = Massachusetts Electric Company  
Nant = Nantucket Electric Company  
NECO = The Narragansett Electric Company  
NECO Gas = Narragansett Electric Company  
NGrid Serv Co = National Grid USA Service Company Inc  
NIMO = Niagara Mohawk Power Corporation  
Information shown in Blue represents a Transmission Function  
Information shown in Red represents a Sales & Marketing Function

Last Updated 11/01/06

# Real Estate Management and Property Tax

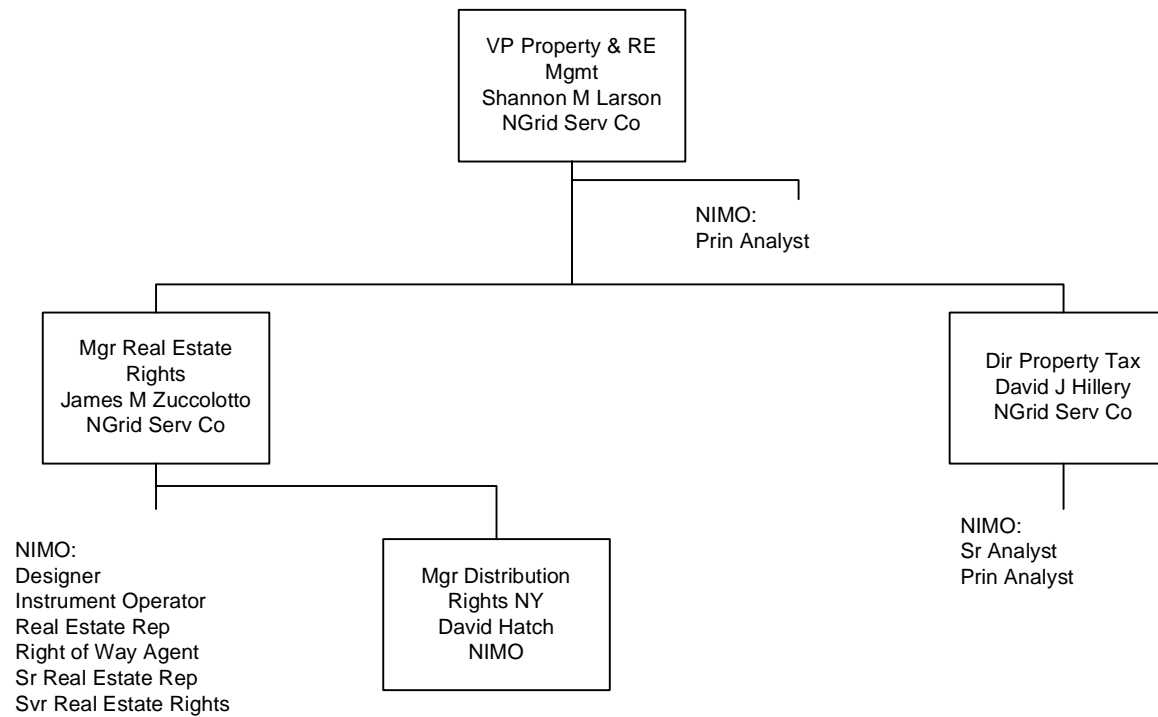

GECO = Granite State Electric Company  
 MECO = Massachusetts Electric Company  
 Nant = Nantucket Electric Company  
 NECO = The Narragansett Electric Company  
 NECO Gas = Narragansett Electric Company  
 NGrid Serv Co = National Grid USA Service Company Inc  
 NIMO = Niagara Mohawk Power Corporation  
 Information shown in Blue represents a Transmission Function  
 Information shown in Red represents a Sales & Marketing Function

## Property and Real Estate Management Facilities

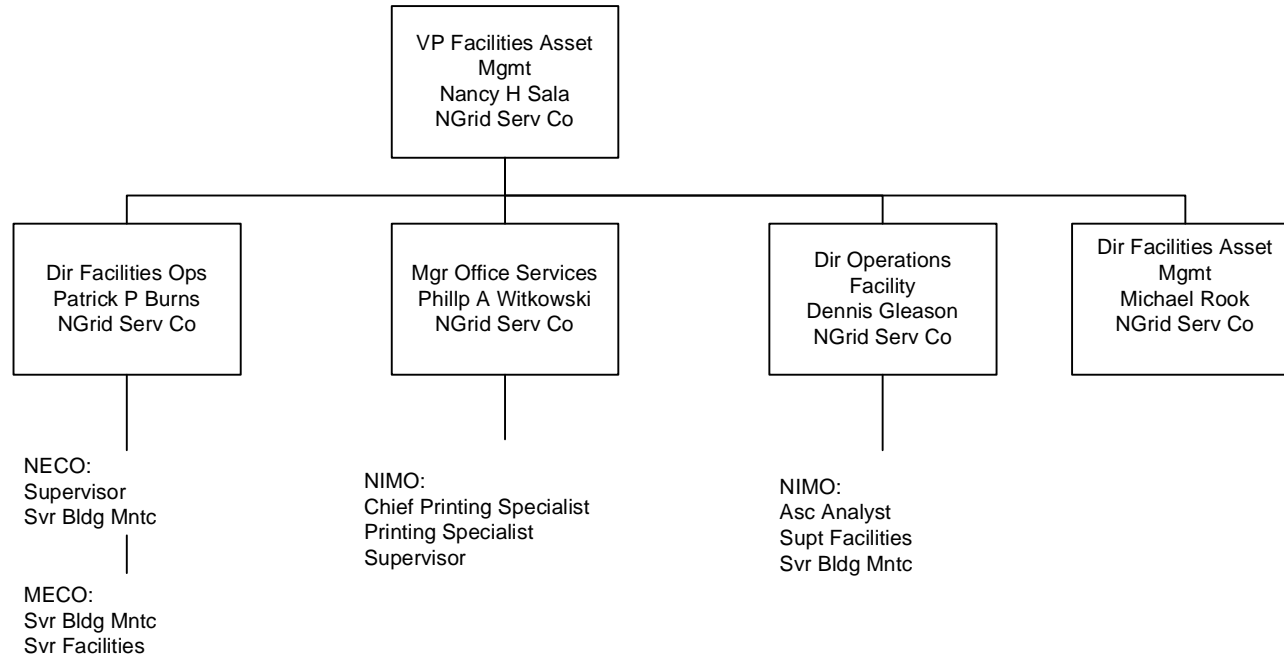

GECO = Granite State Electric Company

MECO = Massachusetts Electric Company

Nant = Nantucket Electric Company

NECO = The Narragansett Electric Company

NECO Gas = Narragansett Electric Company

NGrid Serv Co = National Grid USA Service Company Inc

NIMO = Niagara Mohawk Power Corporation

Information shown in Blue represents a Transmission Function

Information shown in Red represents a Sales & Marketing Function



## Safety & Health, Envir, Security

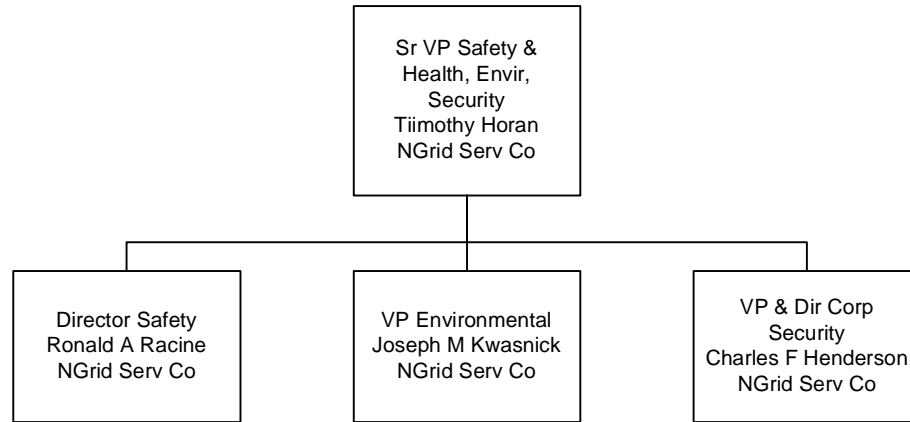

GECO = Granite State Electric Company

MECO = Massachusetts Electric Company

Nant = Nantucket Electric Company

NECO = The Narragansett Electric Company

NECO Gas = Narragansett Electric Company

NGrid Serv Co = National Grid USA Service Company Inc

NIMO = Niagara Mohawk Power Corporation

Information shown in Blue represents a Transmission Function

Information shown in Red represents a Sales & Marketing Function

# Environmental

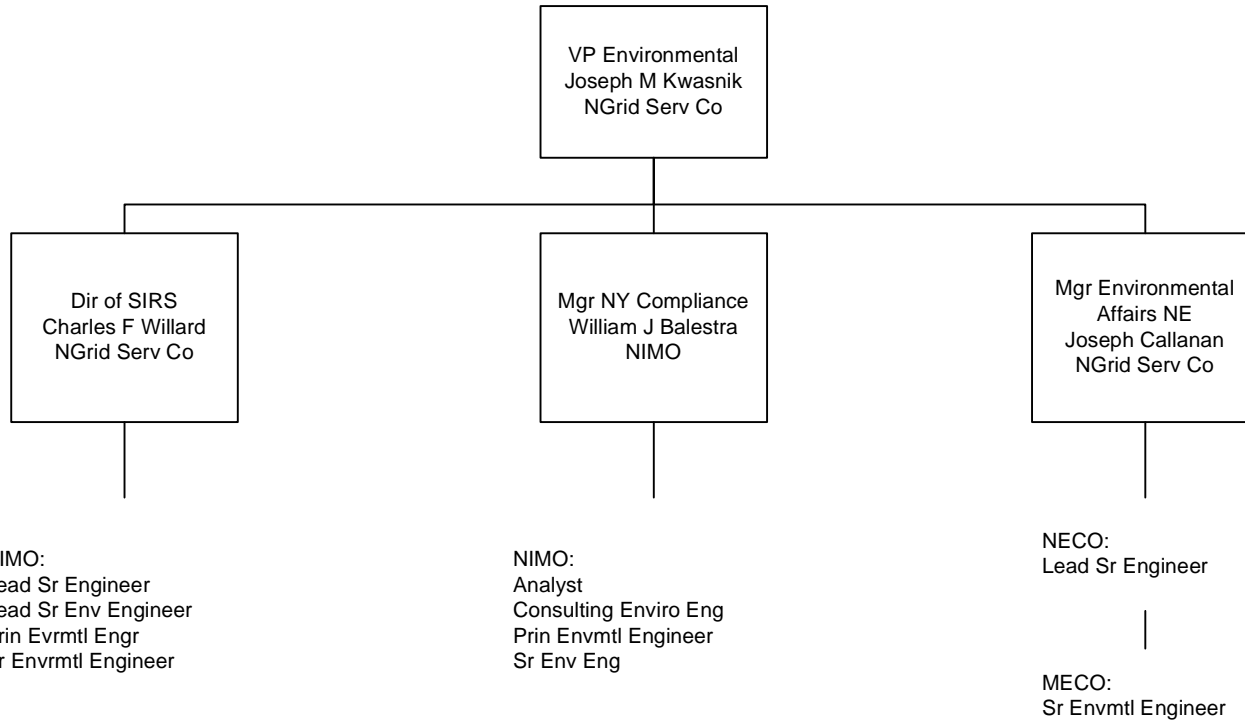

GECO = Granite State Electric Company  
 MECO = Massachusetts Electric Company  
 Nant = Nantucket Electric Company  
 NECO = The Narragansett Electric Company  
 NECO Gas = Narragansett Electric Company  
 NGrid Serv Co = National Grid USA Service Company Inc  
 NIMO = Niagara Mohawk Power Corporation  
 Information shown in Blue represents a Transmission Function  
 Information shown in Red represents a Sales & Marketing Function

Information Technology

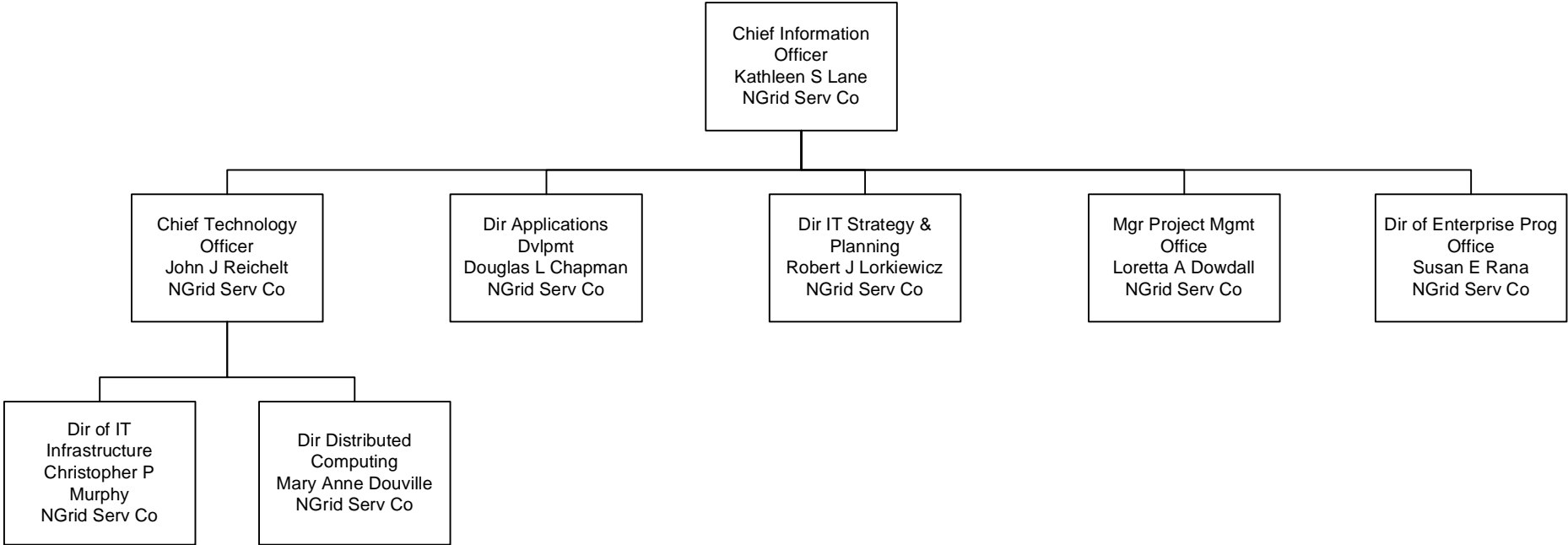

GECS = Granite State Electric Company  
 MECO = Massachusetts Electric Company  
 Nant = Nantucket Electric Company  
 NECO = The Narragansett Electric Company  
 NECO Gas = Narragansett Electric Company  
 NGrid Serv Co = National Grid USA Service Company Inc  
 NIMO = Niagara Mohawk Power Corporation  
 Information shown in Blue represents a Transmission Function  
 Information shown in Red represents a Sales & Marketing Function

# Information Technology Application Development

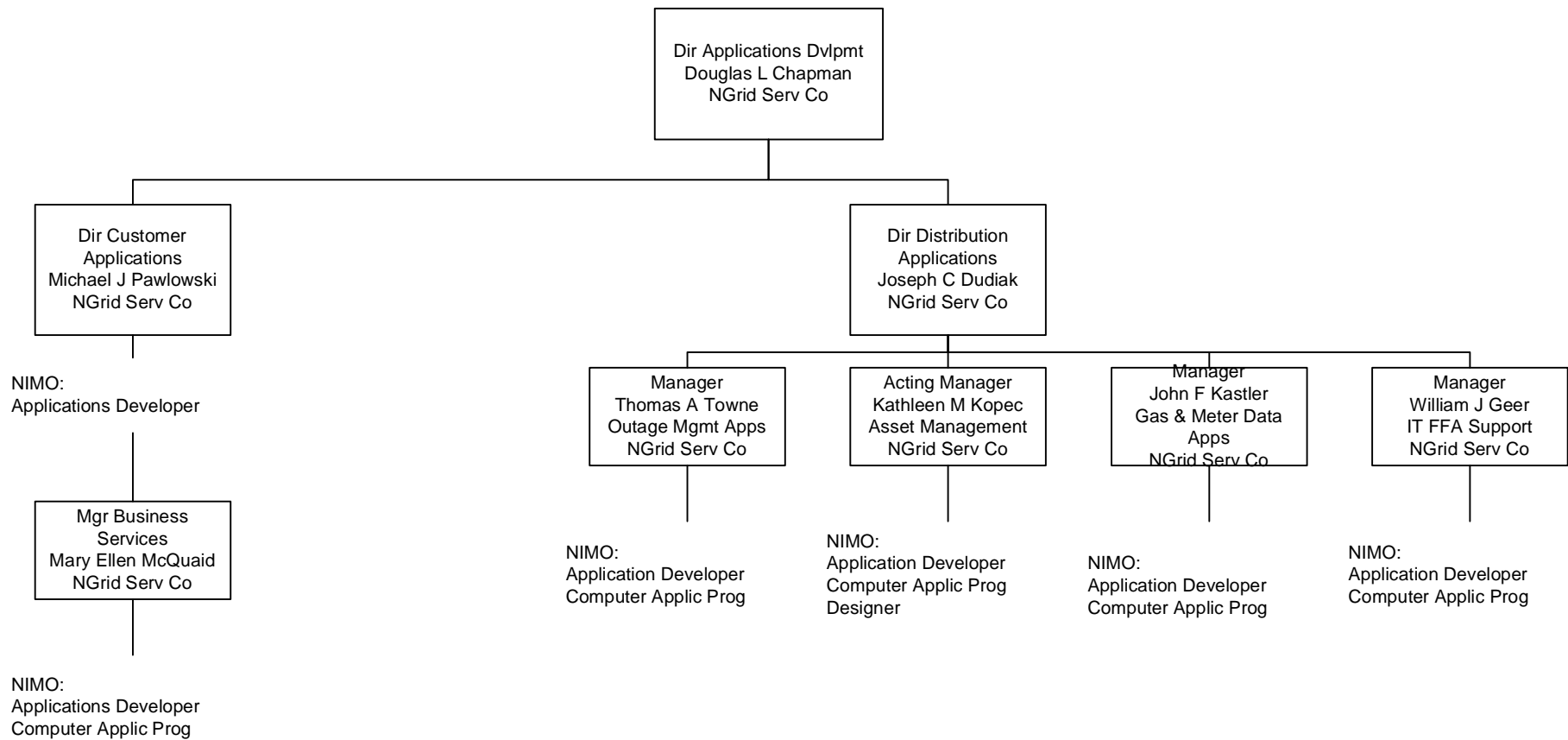

GECS = Granite State Electric Company  
 MECO = Massachusetts Electric Company  
 Nant = Nantucket Electric Company  
 NECO = The Narragansett Electric Company  
 NECO Gas = Narragansett Electric Company  
 NGrid Serv Co = National Grid USA Service Company Inc  
 NIMO = Niagara Mohawk Power Corporation  
 Information shown in Blue represents a Transmission Function  
 Information shown in Red represents a Sales & Marketing Function

# Information Technology Infrastructure

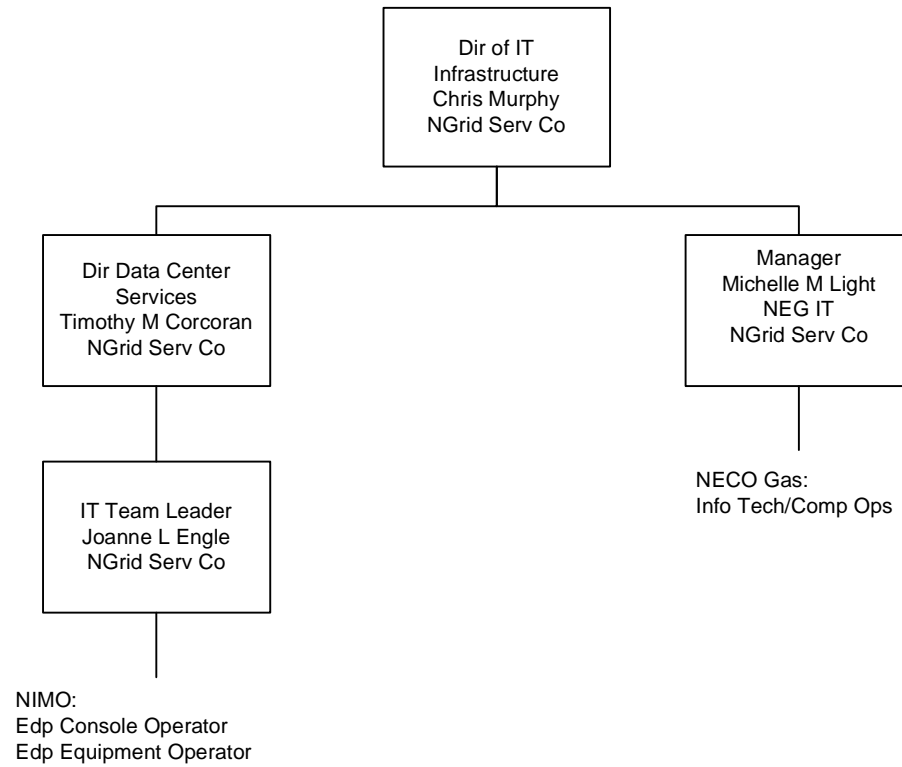

GECO = Granite State Electric Company  
MECO = Massachusetts Electric Company  
Nant = Nantucket Electric Company  
NECO = The Narragansett Electric Company  
NECO Gas = Narragansett Electric Company  
NGrid Serv Co = National Grid USA Service Company Inc  
NIMO = Niagara Mohawk Power Corporation  
Information shown in Blue represents a Transmission Function  
Information shown in Red represents a Sales & Marketing Function

# Business Development

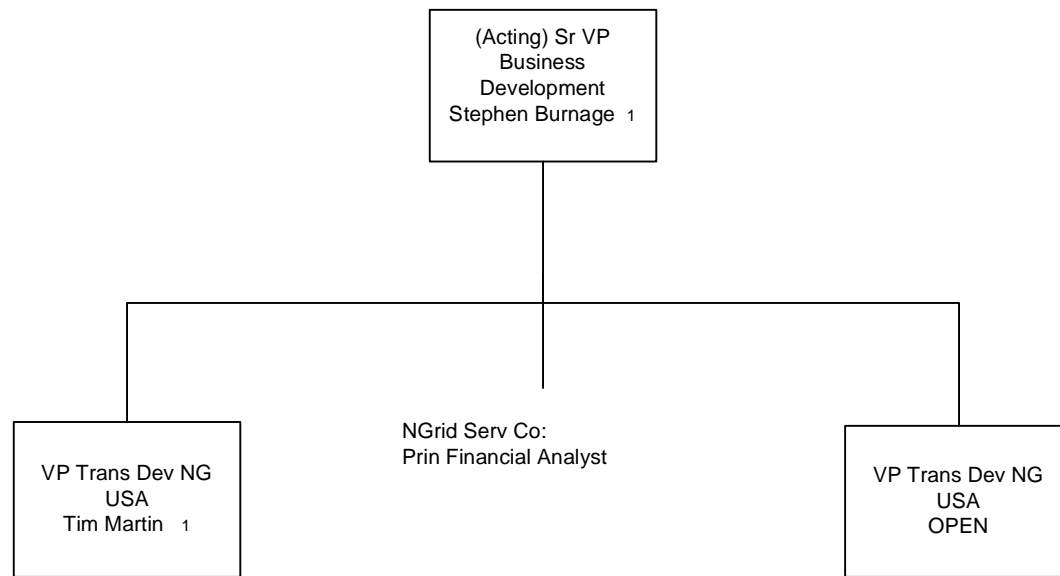

GECO = Granite State Electric Company  
MECO = Massachusetts Electric Company  
Nant = Nantucket Electric Company  
NECO = The Narragansett Electric Company  
NECO Gas = Narragansett Electric Company  
NGrid Serv Co = National Grid USA Service Company Inc  
NIMO = Niagara Mohawk Power Corporation  
Information shown in Blue represents a Transmission Function  
Information shown in Red represents a Sales & Marketing Function

## Mergers and Aquisitions

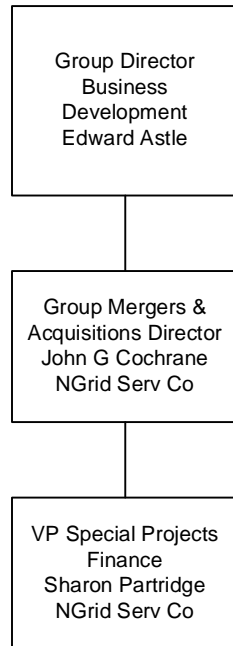

GECO = Granite State Electric Company

MECO = Massachusetts Electric Company

Nant = Nantucket Electric Company

NECO = The Narragansett Electric Company

NECO Gas = Narragansett Electric Company

NGrid Serv Co = National Grid USA Service Company Inc

NIMO = Niagara Mohawk Power Corporation

Information shown in Blue represents a Transmission Function

Information shown in Red represents a Sales & Marketing Function

Last Updated 11/01/06

Finance - CFO

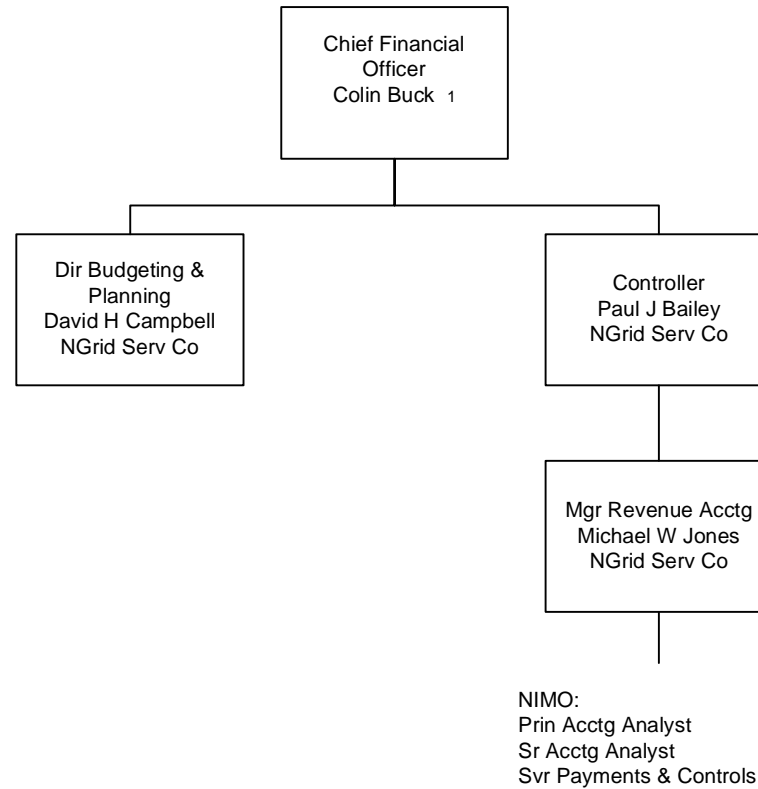

GECO = Granite State Electric Company  
MECO = Massachusetts Electric Company  
Nant = Nantucket Electric Company  
NECO = The Narragansett Electric Company  
NECO Gas = Narragansett Electric Company  
NGrid Serv Co = National Grid USA Service Company Inc  
NIMO = Niagara Mohawk Power Corporation  
Information shown in Blue represents a Transmission Function  
Information shown in Red represents a Sales & Marketing Function



Finance

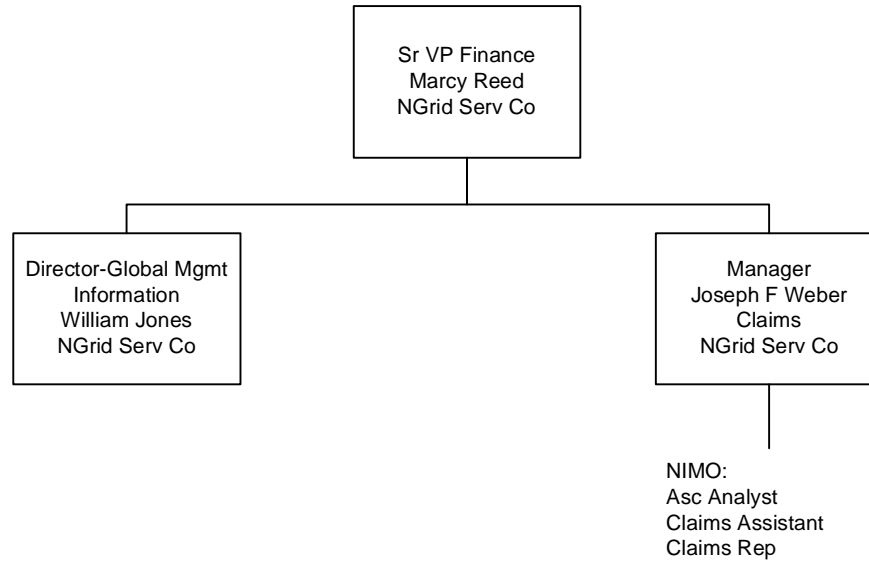

GECO = Granite State Electric Company  
MECO = Massachusetts Electric Company  
Nant = Nantucket Electric Company  
NECO = The Narragansett Electric Company  
NECO Gas = Narragansett Electric Company  
NGrid Serv Co = National Grid USA Service Company Inc  
NIMO = Niagara Mohawk Power Corporation  
Information shown in Blue represents a Transmission Function  
Information shown in Red represents a Sales & Marketing Function

Last Updated 12/11/06

# Human Resources

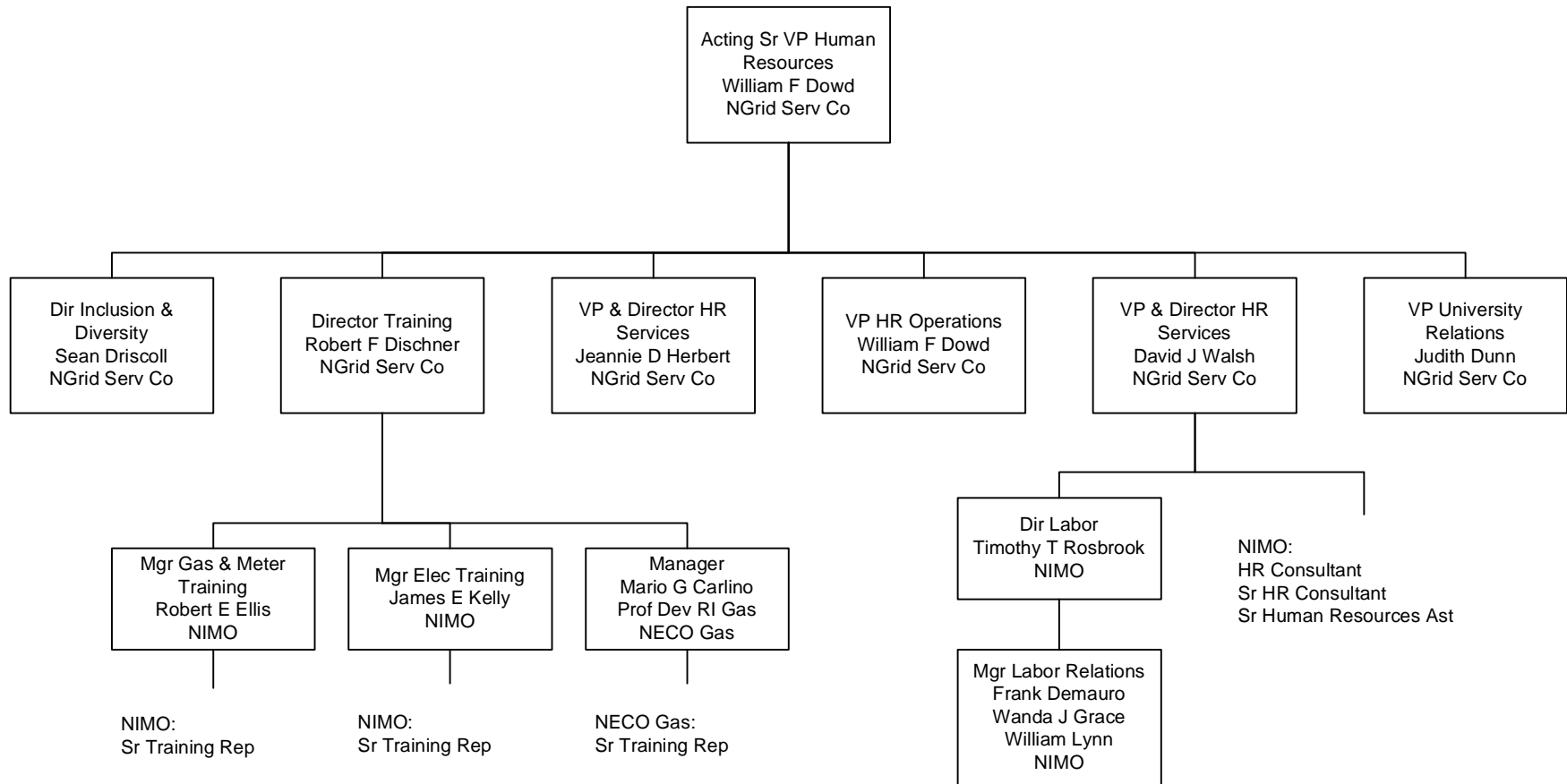

GECS = Granite State Electric Company  
 MECO = Massachusetts Electric Company  
 Nant = Nantucket Electric Company  
 NECO = The Narragansett Electric Company  
 NECO Gas = Narragansett Electric Company  
 NGrid Serv Co = National Grid USA Service Company Inc  
 NIMO = Niagara Mohawk Power Corporation  
 Information shown in Blue represents a Transmission Function  
 Information shown in Red represents a Sales & Marketing Function

Legal

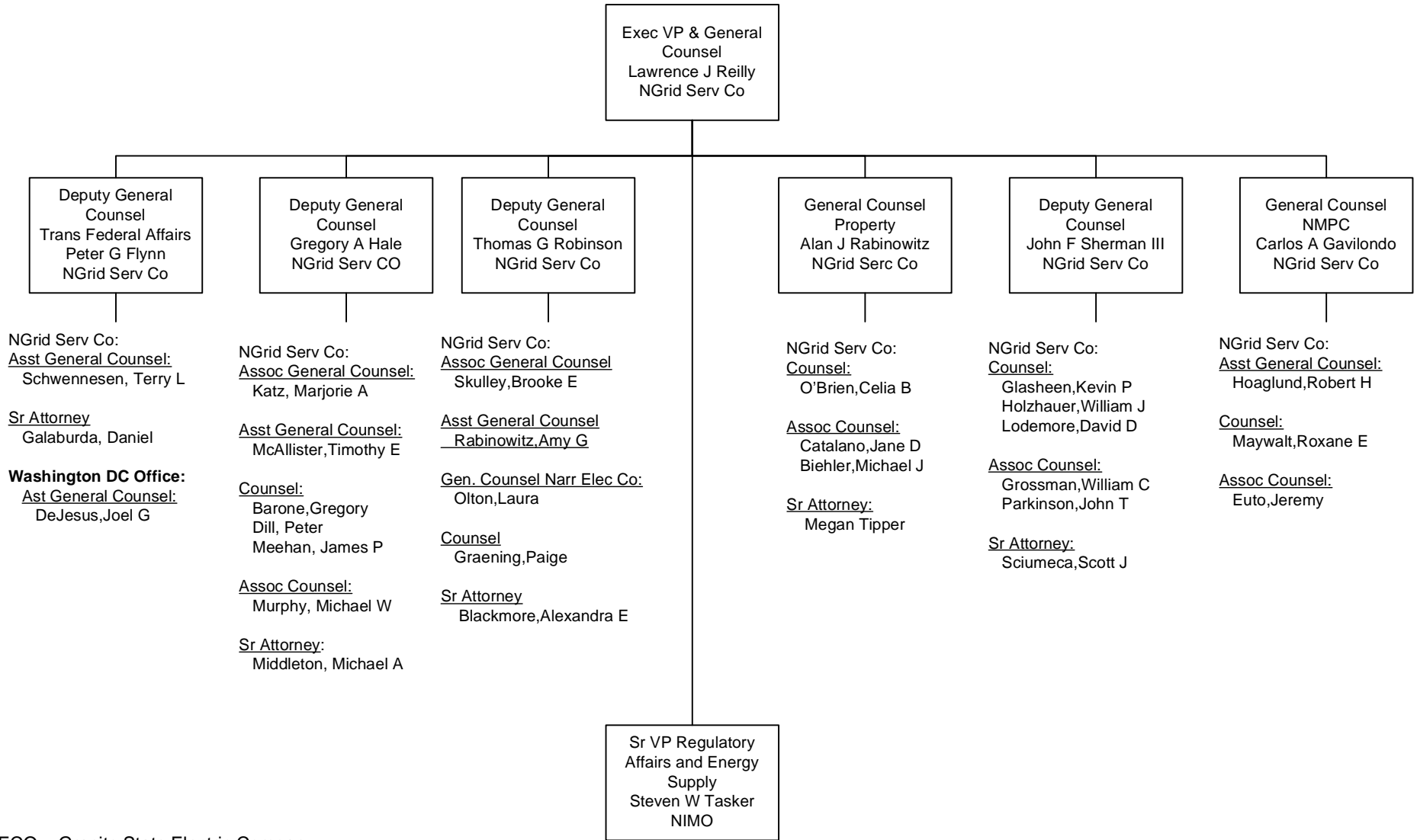

GECO = Granite State Electric Company  
 MECO = Massachusetts Electric Company  
 Nant = Nantucket Electric Company  
 NECO = The Narragansett Electric Company  
 NECO Gas = Narragansett Electric Company  
 NGrid Serv Co = National Grid USA Service Company Inc  
 NIMO = Niagara Mohawk Power Corporation  
 Information shown in Blue represents a Transmission Function  
 Information shown in Red represents a Sales & Marketing Function

Last Updated 02/27/07

## Legal and External Relations

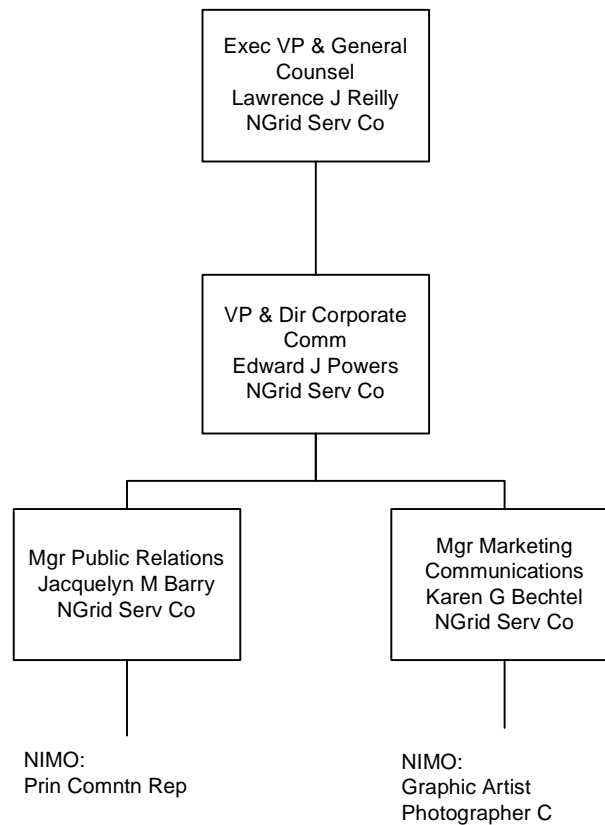

GECO = Granite State Electric Company

MECO = Massachusetts Electric Company

Nant = Nantucket Electric Company

NECO = The Narragansett Electric Company

NECO Gas = Narragansett Electric Company

NGrid Serv Co = National Grid USA Service Company Inc

NIMO = Niagara Mohawk Power Corporation

Information shown in Blue represents a Transmission Function

Information shown in Red represents a Sales & Marketing Function

Last Updated 03/09/07

# New York Regulatory Affairs

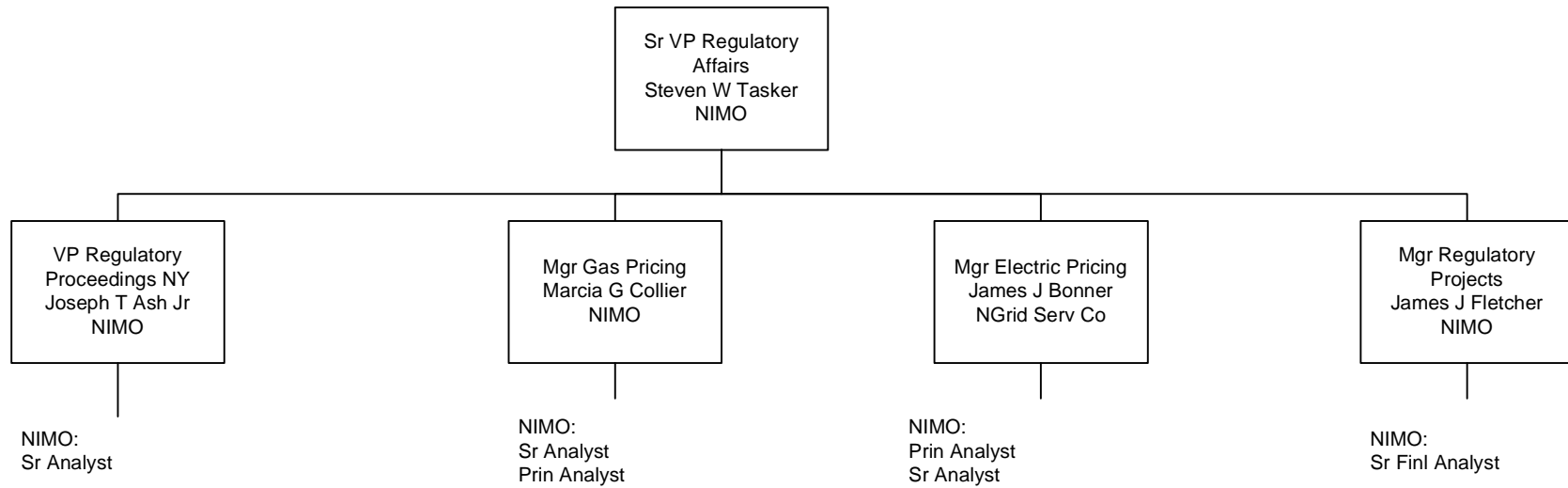

GECO = Granite State Electric Company  
MECO = Massachusetts Electric Company  
Nant = Nantucket Electric Company  
NECO = The Narragansett Electric Company  
NECO Gas = Narragansett Electric Company  
NGrid Serv Co = National Grid USA Service Company Inc  
NIMO = Niagara Mohawk Power Corporation  
Information shown in Blue represents a Transmission Function  
Information shown in Red represents a Sales & Marketing Function