

a) See explanatory footnote next page

b) Includes **transmission function** employees, employees engaged in **Marketing, Sales** or Energy Affiliate activities, and shared support units. The shared support units are identified and described in the document posted under Shared Services.

a) Massachusetts Electric Company and The Narragansett Electric Company own transmission facilities and are classified as “transmission Providers” under Order No. 2004. However, they do not provide transmission service under Order No. 888/889. Instead, these facilities are controlled and operated by New England Power as part of its integrated transmission system pursuant to the integrated facilities provisions of its FERC Electric Tariff, Original Volume No.1, Schedule III-B.

Similarly, New England Electric Transmission Company, New England Hydro-Transmission Company, and New England Hydro-Transmission Electric Company (collectively “the Hydro Companies”) are also all designated as “transmission providers” because they collectively own a high voltage, direct current transmission facility but do not provide transmission service over that facility. Instead the capacity has been fully subscribed by supporting utilities who have exclusive rights to use their respective shares of the capacity. New England Power Company is one such supporting utility, and it provides transmission service over its respective share of the facility under ISO-NE’s open access transmission tariff. See *New England Hydro-Transmission Corporation, et al.*, 39 FERC ¶ 61,288 (1987) (order approving various agreements including Support Agreements); *Northern States Power Company (Minnesota), et al.*, 76 FERC ¶ 61,250 at 62,296 (1996), *order on rehearing, Black Creek Hydro, Inc. et al.*, 77 FERC ¶ 61,232 at 61,943 (1996) (granting waiver of Order No. 888 for the Hydro Companies).

Shared Services

Human Resources Services – consults and collaborates with management to develop and implement HR strategies in the areas of workforce planning, employment, organizational design, organizational development and performance management.

Labor Relations – responsible for negotiation, interpretation and administration of collective bargaining agreements.

Employee Services – responsible for employee transactions, employee call center, policy interpretation, maintenance of personnel records, complaint investigations and compliance with applicable laws and rules affecting employees.

Payroll – responsible for all aspects of payroll processing.

HR IS – responsible for human resources data needs.

Health & Welfare Plan – responsible for the design, implementation and management of welfare benefit plans.

Compensation – designs, plans, implements and administers corporate compensation programs, policies and procedures including incentive plans.

Corporate Security – management of all aspects of security, including contract security, threat management, and liaison with state and federal law enforcement.

Corporate Communications – management of media relations, employee communications, customer communications, corporate advertising and marketing, and community relations.

Transmission and Federal Affairs – responsible for federal regulatory affairs and legal support for the Transmission organization.

Commercial – responsible for corporate and commercial legal matters.

Regulatory – responsible for state regulatory affairs.

Property – responsible for property and real estate matters and transactions.

Litigation - responsible for commercial litigation, environmental law, personal injury and property damage claims and compliance.

Distribution Regulatory Services - responsible for the regulatory proceedings in the state of Massachusetts including regulatory filings and handling of all state government interactions; analyzes proposed legislative actions and determines the potential impact on the organization; monitors legislative and regulatory activities and develops company positions.

Regulatory Strategy and Research - responsible for the development of regulatory strategy that supports and implements the business plan; conduct research on regulatory activities in other state and federal jurisdictions that affect NG business model and business plan; keep management informed of regulatory developments and assist business development team in assessment of regulatory matters.

New York Regulatory Affairs - responsible for pricing of electric and gas services, administration of electric and gas tariffs and related filings, and establishing and maintaining Company policies in regards to pricing, as well as providing regulatory financial advice and guidance with respect to state proceedings

Ethics & Compliance – responsible for governance and compliance related programs and initiatives, including standards of conduct, ethics, risk and compliance management, and environmental and safety compliance audit.

Internal Audit – is responsible for providing Management and the Audit Committee and the Board of National Grid Transco with an independent assessment of the adequacy and effectiveness of the Company's management systems and related controls.

IT Infrastructure – responsible for the design, deployment, and operations of the computing and communications infrastructure, as well as the Energy Management Systems used to operate the electric system within the National Grid service territory.

Applications Development – responsible for the development, configuration, and support of business software applications.

Strategy & Planning – provides support and planning services related to enterprise architecture, cyber security, cost accounting and budgeting, contract and asset management and disaster recovery.

Treasury Services – provides corporate finance and banking services to all entities within the National Grid USA group of companies.

Investment Management – is responsible for overseeing the investments in the employee benefit trusts.

Claims – investigates, evaluates and disposes of third party claims.

Revenue Accounting – responsible for revenue reporting, account receivable and miscellaneous billing.

Financial Reporting – responsible for creating, summarizing, and reporting financial statements and disclosures to the parent company and third parties.

System Support – ensures the effective operation and use of the ERP systems by working with business owners, Information Technology, and ERP Support.

Accounting Services – responsible for maintaining the financial books and records of the National Grid USA group of companies.

Corporate Tax – responsible for tax return compliance, managing federal and state audits, tax research and planning, and accounting for income taxes.

Real Estate Management & Property Tax – responsible for managing property tax and acquiring and disposing of real estate rights.

Forecasting, Budgeting and Planning – is responsible for the consolidation and reporting of all National Grid USA financial forecasts, budgets and business plans to NGT Corporate Finance.

Substation Engineering – operational and design support for substations

Delivery Engineering – operational and design support for power lines

Protection & Meter Engineering – operational and design support for power system controls and metering

Lab and Testing Services – meter and rubber goods testing and services, field and laboratory services, and instrument service and repair.

T&D Systems Engineering – system performance and asset strategy analysis, benchmarking and R&D.

Technical Training – technical training for electric and gas businesses

Environmental – environmental compliance support services

Meter & Data Services – acquire, process, analyze and distribute energy information for use in market settlement and customer billing

Process & Systems – development, implementation, and ongoing user support of operations applications

Fleet Management – asset management including service and repair of corporate transportation fleet.

Supply Chain – procurement, accounts payable, and inventory management services.

Facilities Asset Management – operation and maintenance of employee occupied facilities

Health and Safety Services – provides regulatory required records and reporting of occupational injuries, safety committee and management professional support, safety observation tours, medical surveillance and DOT required reporting, Employee Assistance Program, and regulatory guidance, interpretation, and accompanying policies and procedures.

Transmission

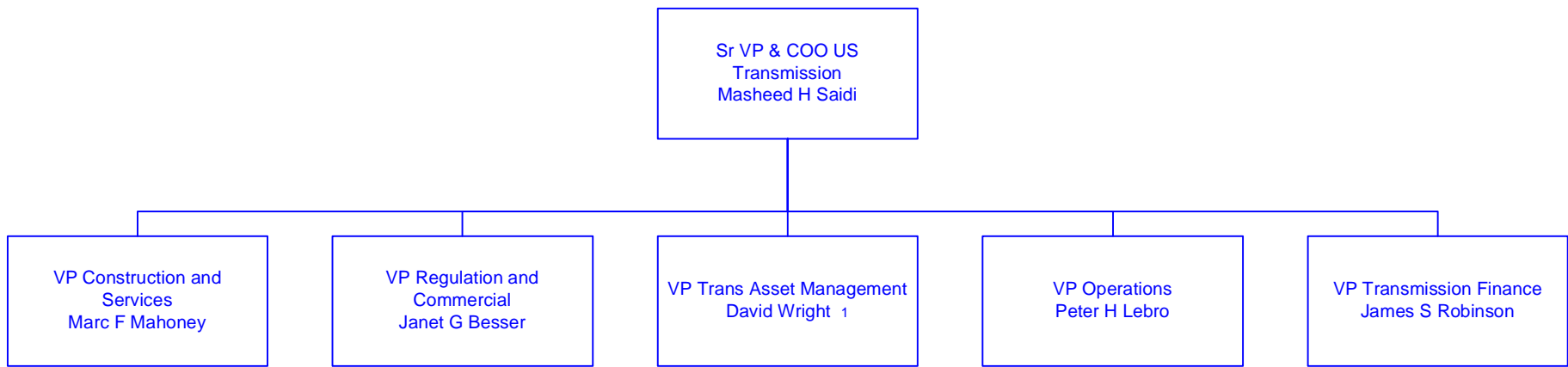

All employees shown on this page are employed by National Grid USA Service Co.
Information shown in blue represents a Transmission Function

Last Updated 11/01/06

Transmission Construction and Services

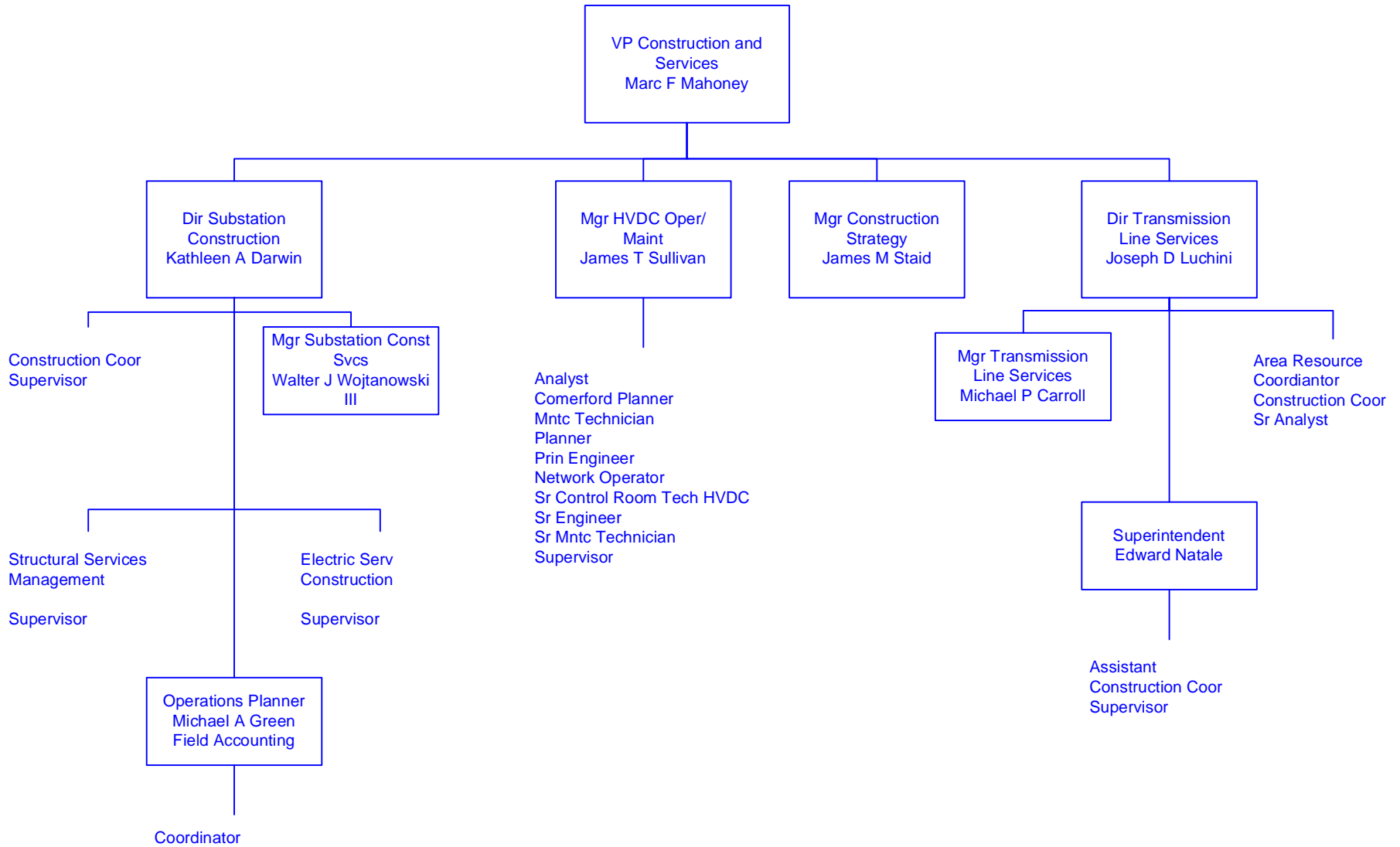

All employees shown on this page are employed by National Grid USA Service Co.
Information shown in blue represents a Transmission Function

Last Updated 01/16/07

Transmission Regulation and Commercial

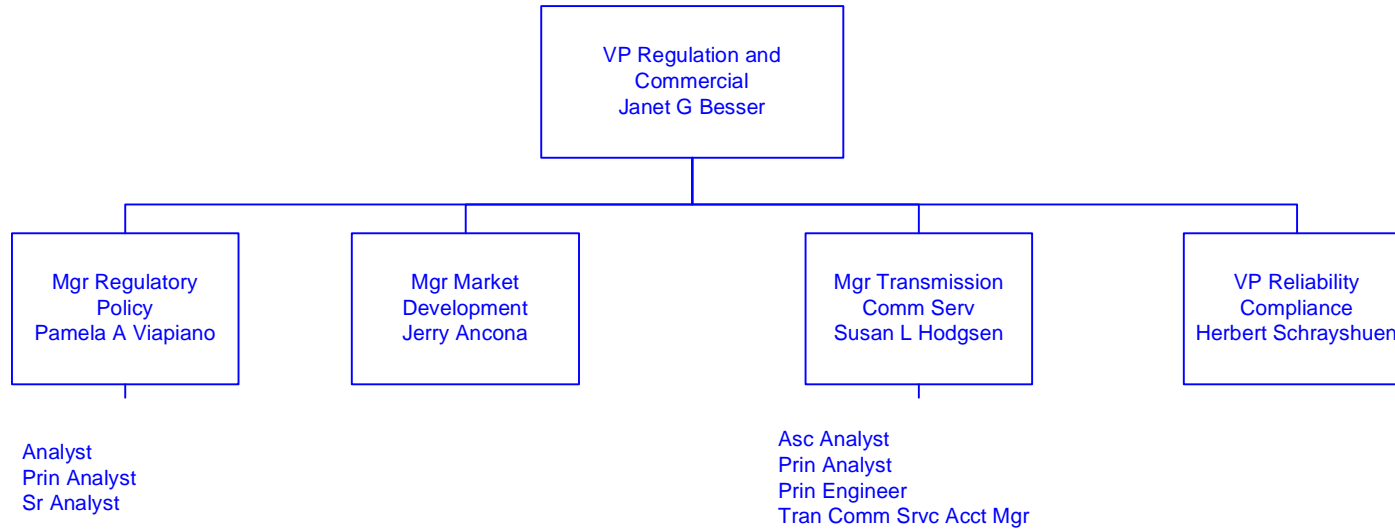

All employees shown on this page are employed by National Grid USA Service Co.
Information shown in blue represents a Transmission Function

Last Updated 12/11/06

Transmission Network Operations

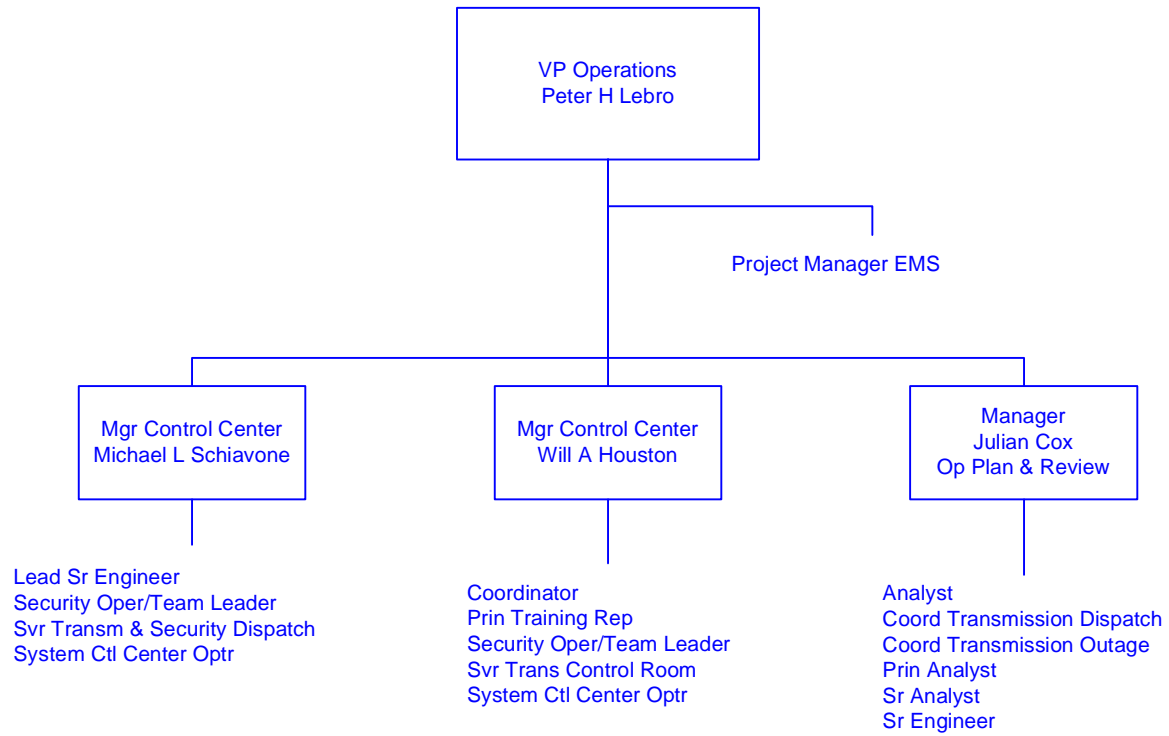

All employees shown on this page are employed by National Grid USA Service Co.
Information shown in blue represents a Transmission Function

Last Updated 03/20/07

Transmission Finance

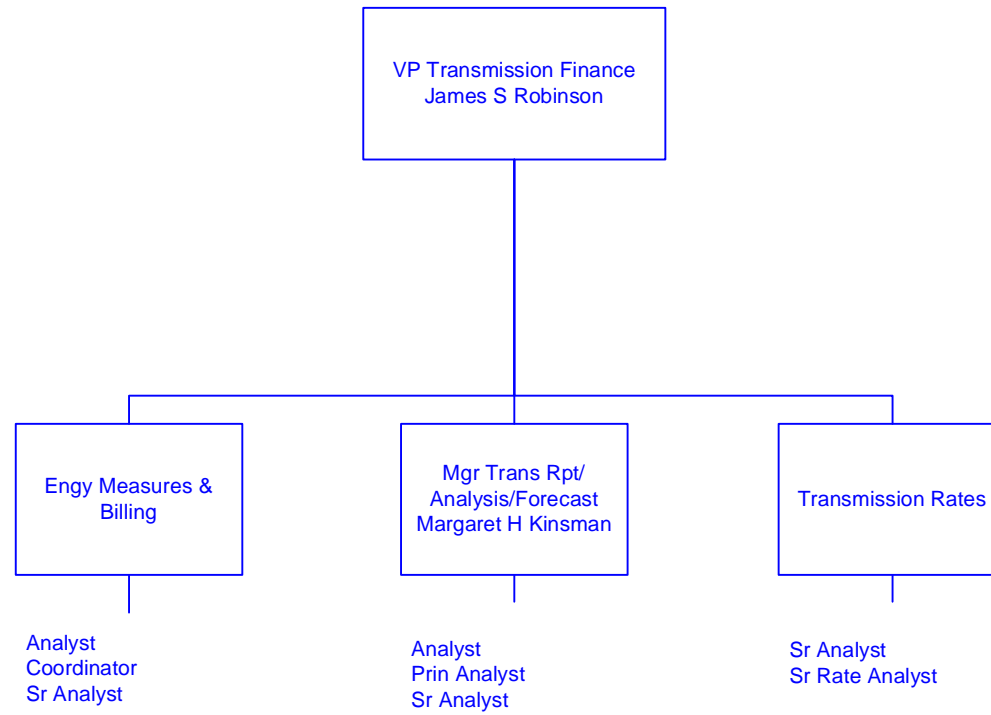

All employees shown on this page are employed by National Grid USA Service Co.
Information shown in blue represents a Transmission Function

Last Updated 02/05/07

Transmission Asset Management

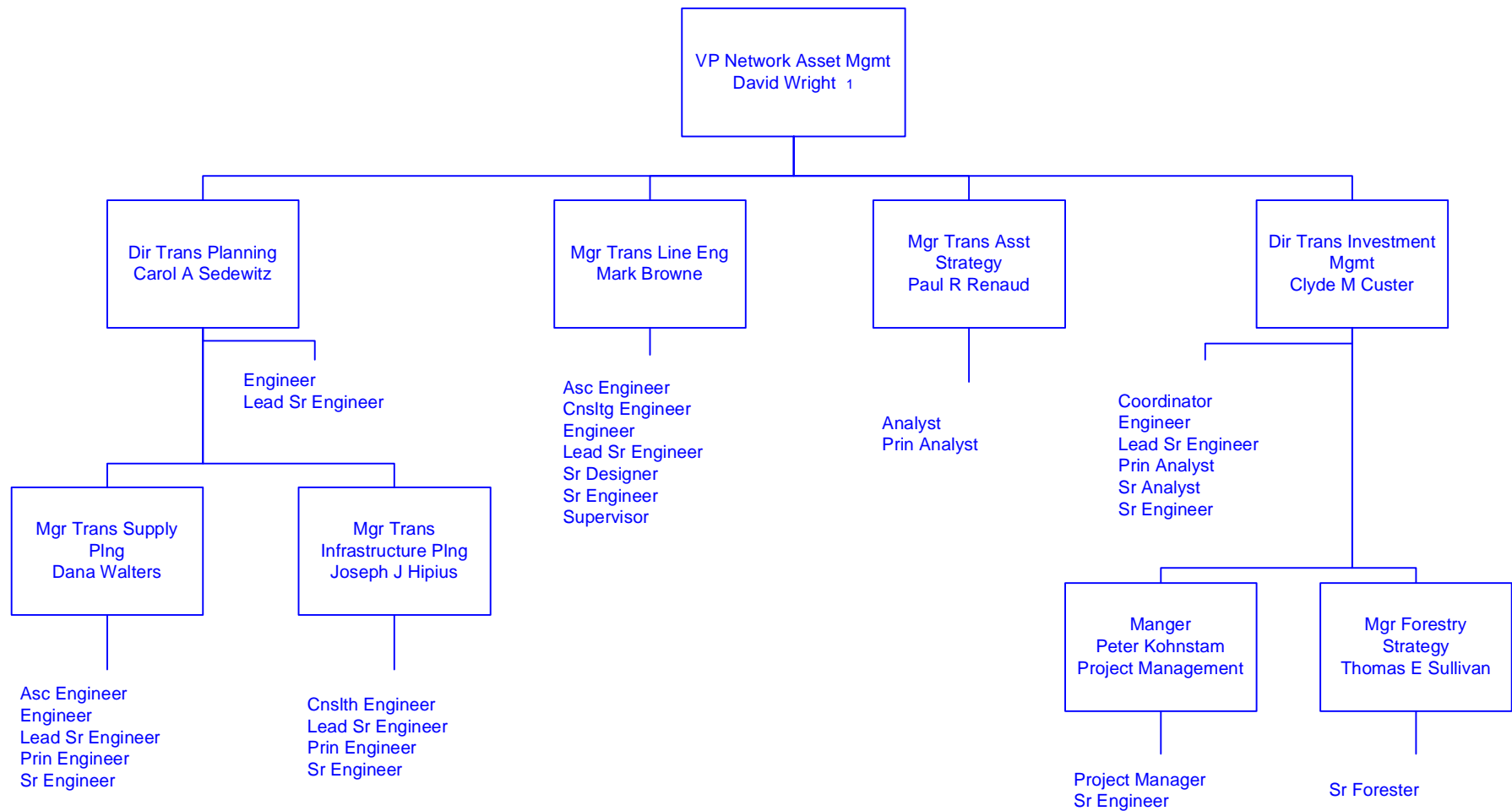

All employees shown on this page are employed by National Grid USA Service Co.
Information shown in blue represents a Transmission Function

Last Updated 03/12/07

National Grid USA

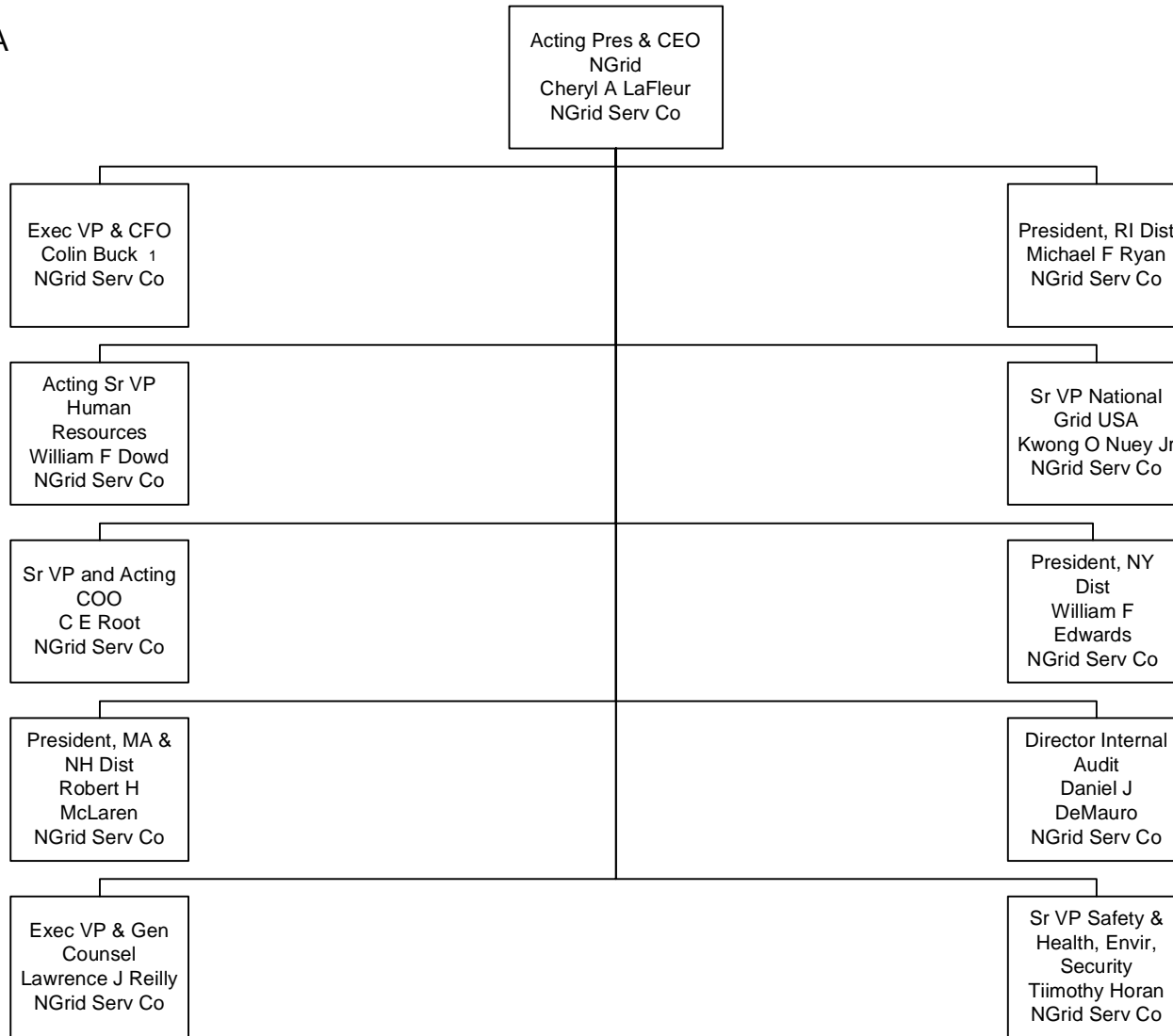

GECO = Granite State Electric Company
 MECO = Massachusetts Electric Company
 Nant = Nantucket Electric Company
 NECO = The Narragansett Electric Company
 NECO Gas = Narragansett Electric Company
 NGrid Serv Co = National Grid USA Service Company Inc
 NIMO = Niagara Mohawk Power Corporation
 Information shown in Blue represents a Transmission Function
 Information shown in Red represents a Sales & Marketing Function

Business Service MA and NH

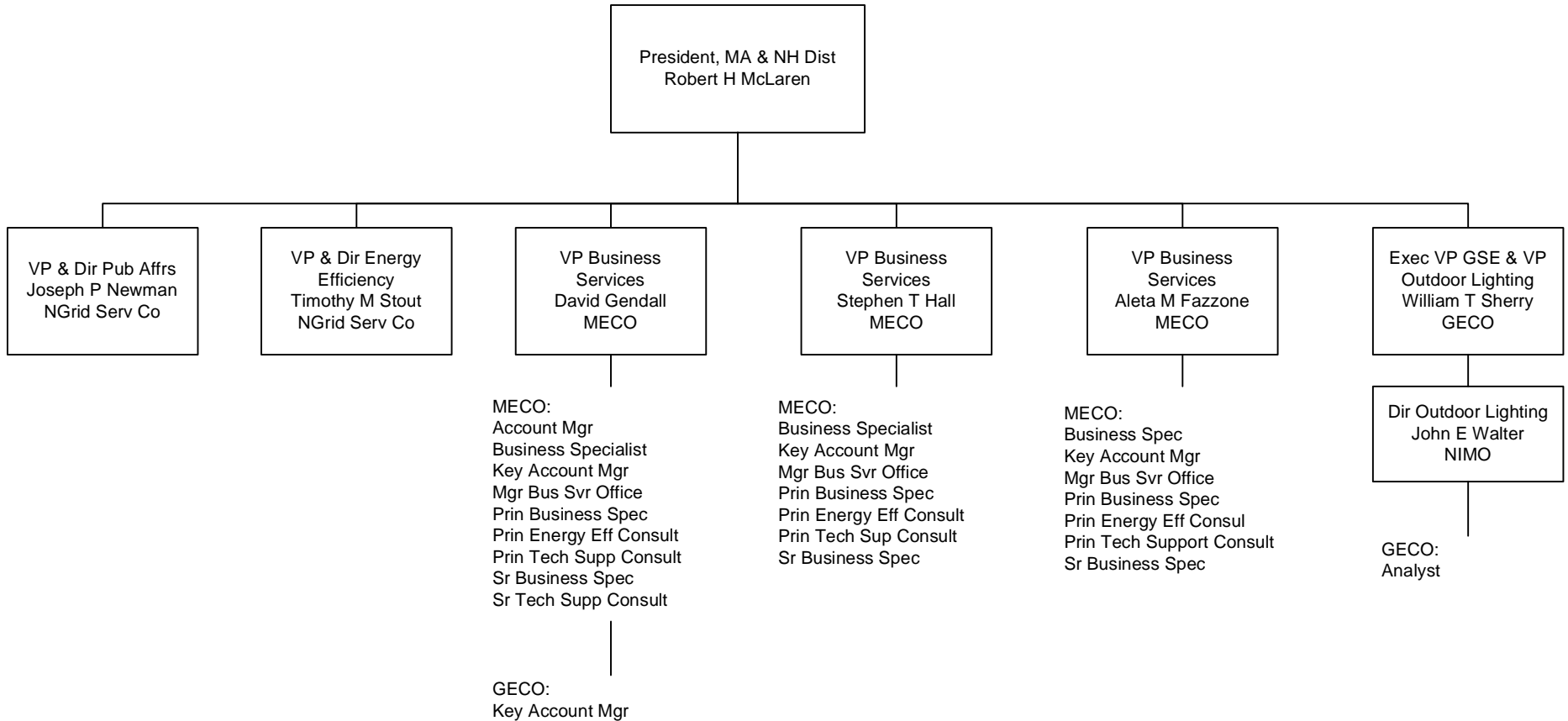

GECO = Granite State Electric Company
 MECO = Massachusetts Electric Company
 Nant = Nantucket Electric Company
 NECO = The Narragansett Electric Company
 NECO Gas = Narragansett Electric Company
 NGrid Serv Co = National Grid USA Service Company Inc
 NIMO = Niagara Mohawk Power Corporation
 Information shown in Blue represents a Transmission Function
 Information shown in Red represents a Sales & Marketing Function

Business Service RI

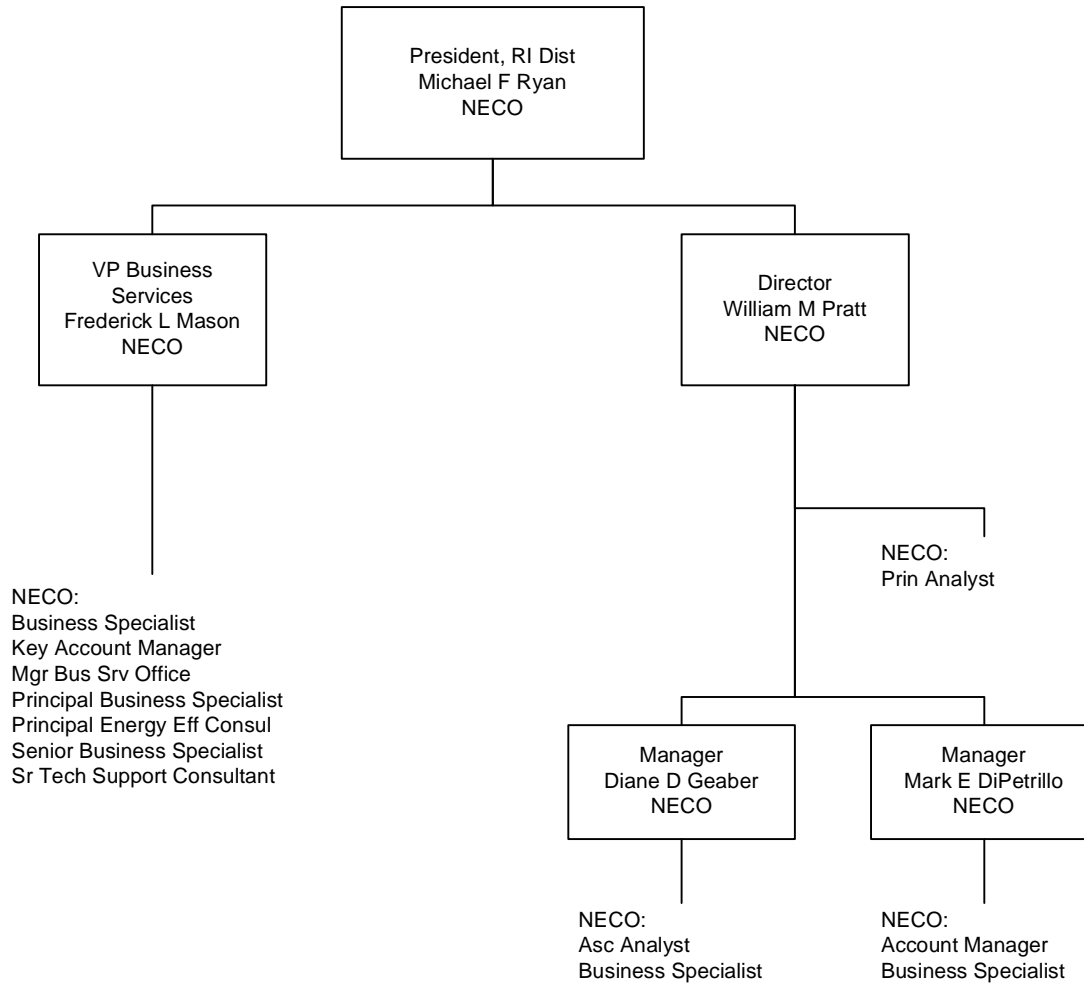

GECO = Granite State Electric Company
 MECO = Massachusetts Electric Company
 Nant = Nantucket Electric Company
 NECO = The Narragansett Electric Company
 NECO Gas = Narragansett Electric Company
 NGrid Serv Co = National Grid USA Service Company Inc
 NIMO = Niagara Mohawk Power Corporation
 Information shown in Blue represents a Transmission Function
 Information shown in Red represents a Sales & Marketing Function

Operations

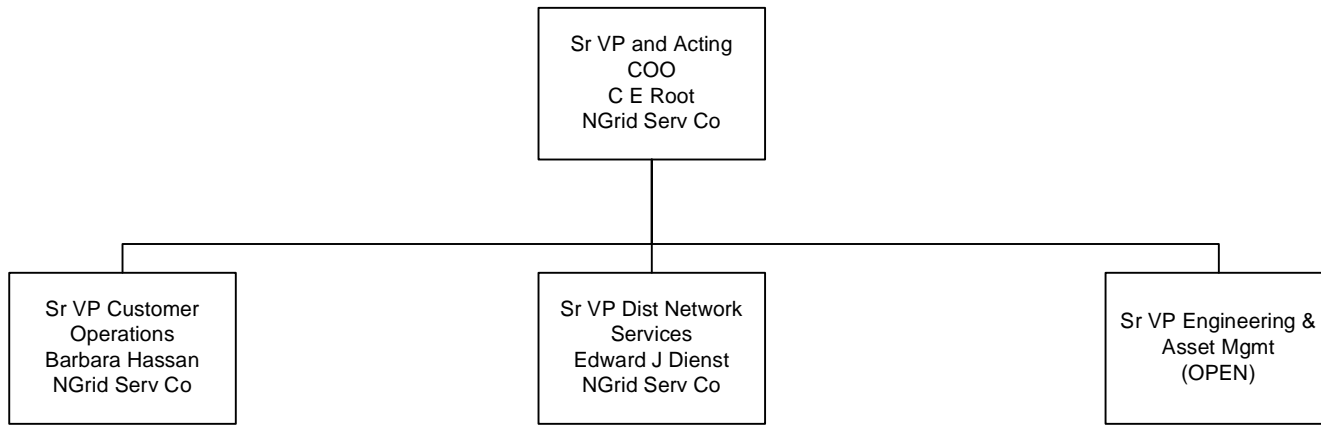

GECO = Granite State Electric Company
MECO = Massachusetts Electric Company
Nant = Nantucket Electric Company
NECO = The Narragansett Electric Company
NECO Gas = Narragansett Electric Company
NGrid Serv Co = National Grid USA Service Company Inc
NIMO = Niagara Mohawk Power Corporation
Information shown in Blue represents a Transmission Function
Information shown in Red represents a Sales & Marketing Function

Distribution Operations

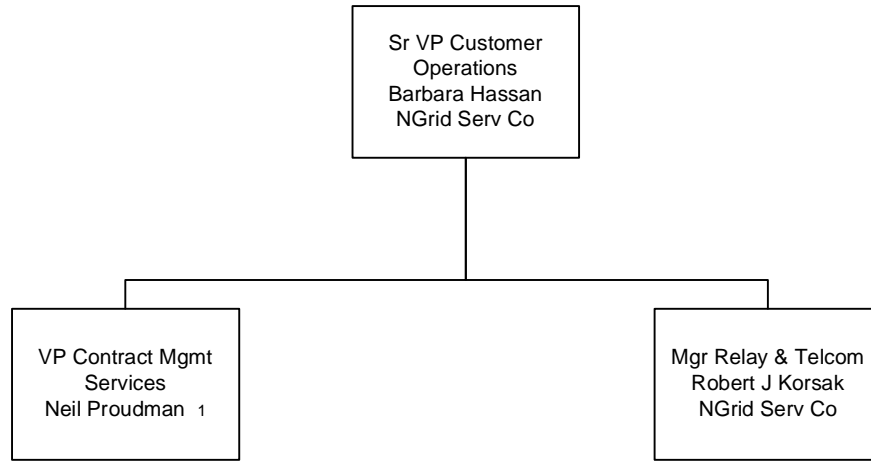

GECO = Granite State Electric Company

MECO = Massachusetts Electric Company

Nant = Nantucket Electric Company

NECO = The Narragansett Electric Company

NECO Gas = Narragansett Electric Company

NGrid Serv Co = National Grid USA Service Company Inc

NIMO = Niagara Mohawk Power Corporation

Information shown in Blue represents a Transmission Function

Information shown in Red represents a Sales & Marketing Function

Distribution Network Services

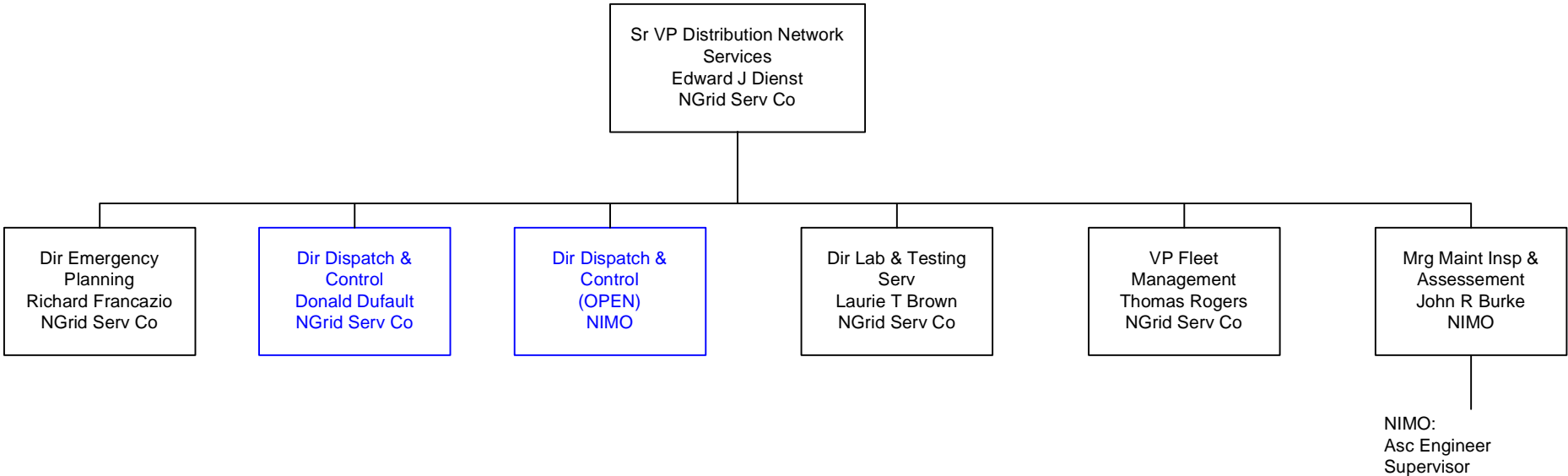

GECO = Granite State Electric Company
 MECO = Massachusetts Electric Company
 Nant = Nantucket Electric Company
 NECO = The Narragansett Electric Company
 NECO Gas = Narragansett Electric Company
 NGrid Serv Co = National Grid USA Service Company Inc
 NIMO = Niagara Mohawk Power Corporation
 Information shown in Blue represents a Transmission Function
 Information shown in Red represents a Sales & Marketing Function

New England Distribution Dispatch and Control

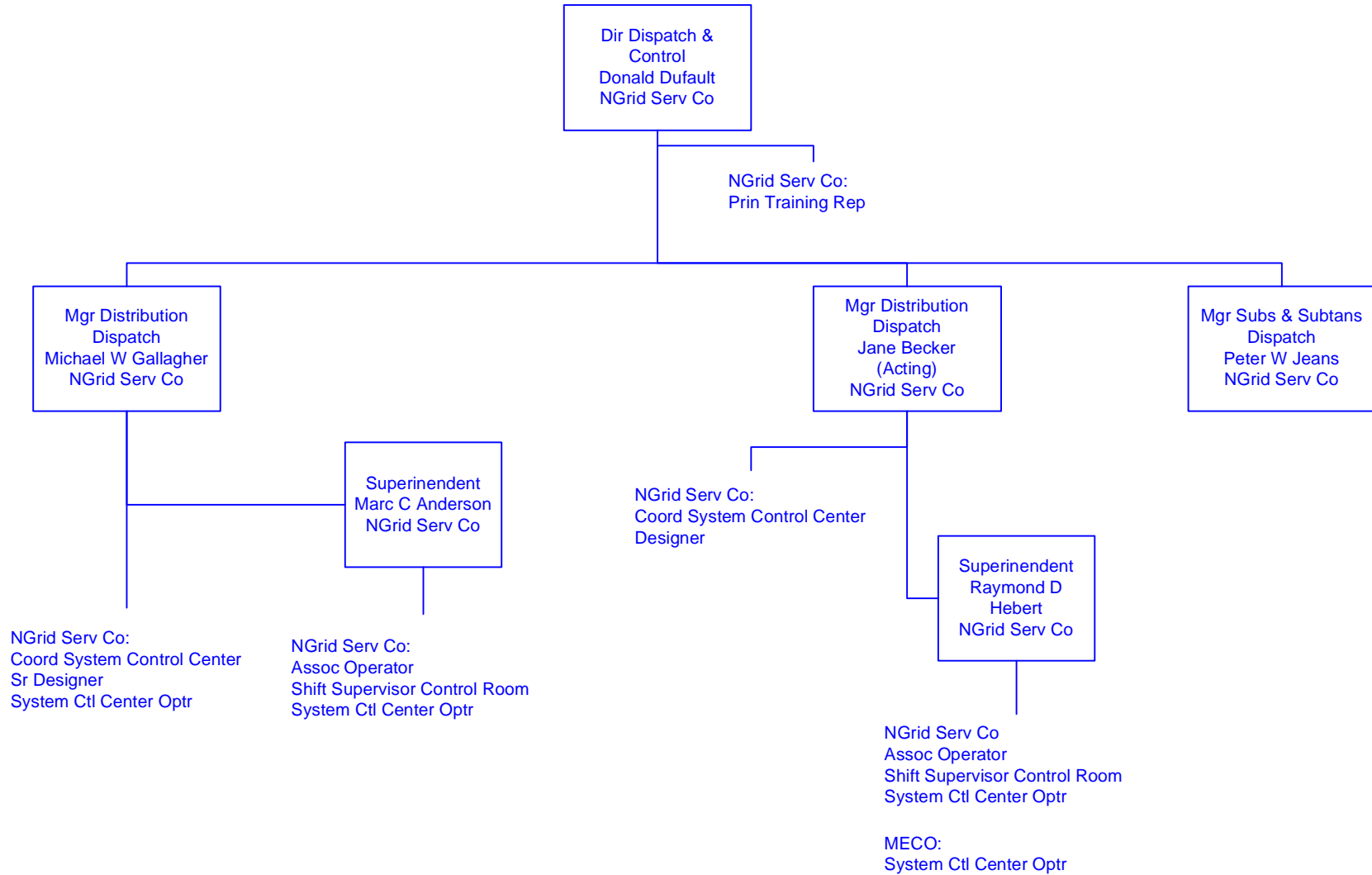

GECO = Granite State Electric Company
 MECO = Massachusetts Electric Company
 Nant = Nantucket Electric Company
 NECO = The Narragansett Electric Company
 NECO Gas = Narragansett Electric Company
 NGrid Serv Co = National Grid USA Service Company Inc
 NIMO = Niagara Mohawk Power Corporation
 Information shown in Blue represents a Transmission Function
 Information shown in Red represents a Sales & Marketing Function

New York Distribution Dispatch and Control

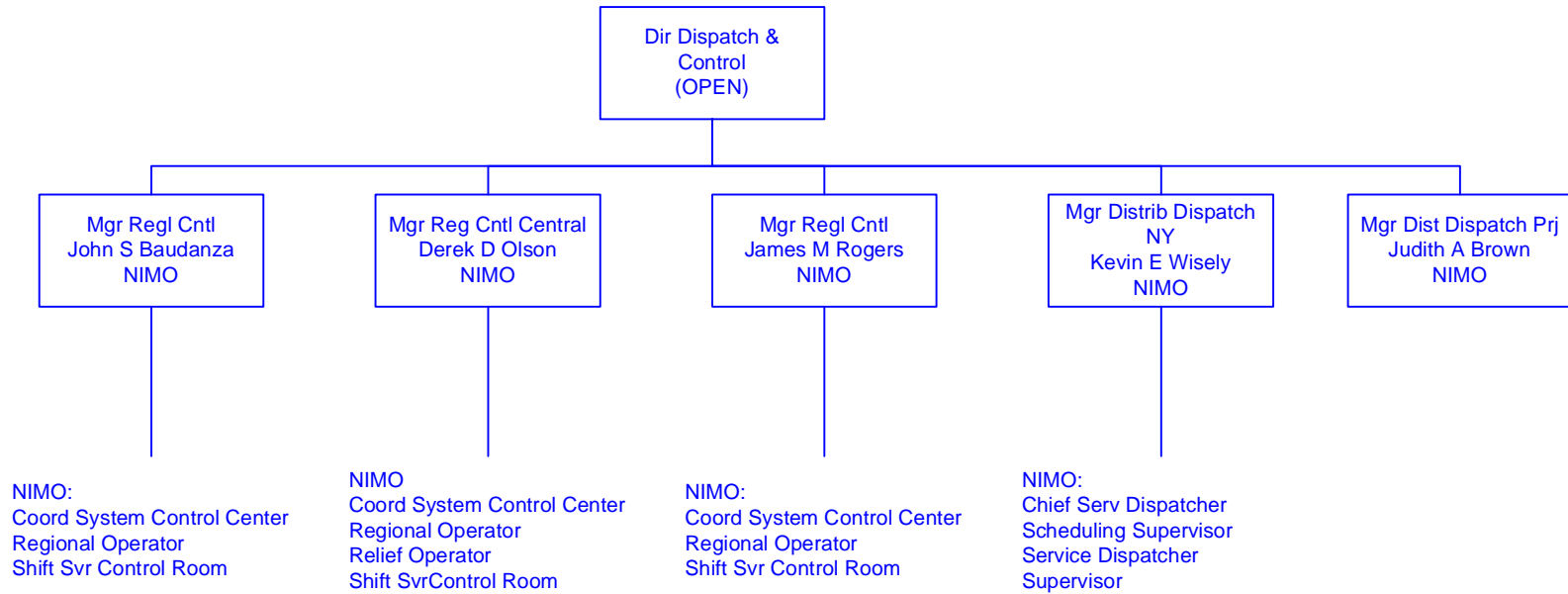

GECCO = Granite State Electric Company
 MECO = Massachusetts Electric Company
 Nant = Nantucket Electric Company
 NECO = The Narragansett Electric Company
 NECO Gas = Narragansett Electric Company
 NGrid Serv Co = National Grid USA Service Company Inc
 NIMO = Niagara Mohawk Power Corporation
 Information shown in Blue represents a Transmission Function
 Information shown in Red represents a Sales & Marketing Function

Lab and Testing Services

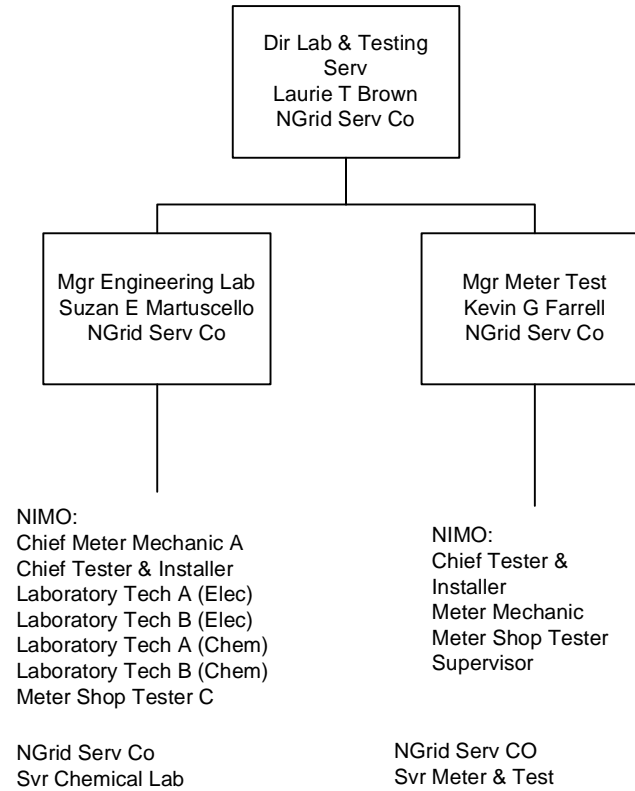

GECO = Granite State Electric Company

MECO = Massachusetts Electric Company

Nant = Nantucket Electric Company

NECO = The Narragansett Electric Company

NECO Gas = Narragansett Electric Company

NGrid Serv Co = National Grid USA Service Company Inc

NIMO = Niagara Mohawk Power Corporation

Information shown in Blue represents a Transmission Function

Information shown in Red represents a Sales & Marketing Function

Last Updated 11/01/06

Fleet Management

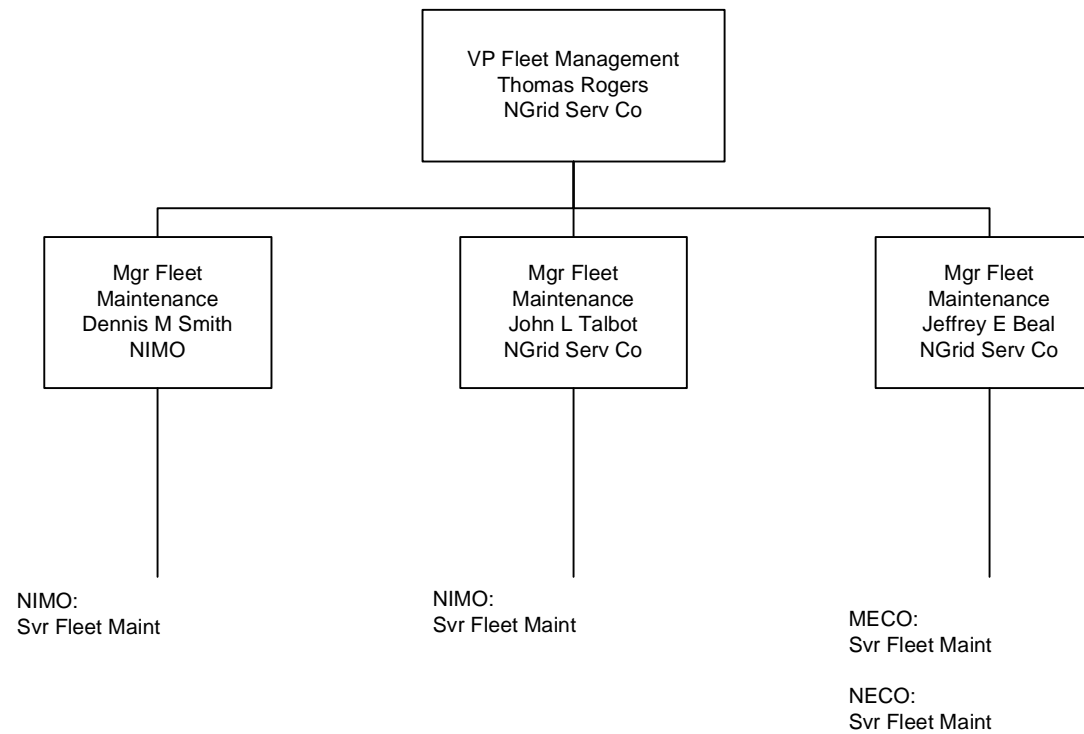

GECO = Granite State Electric Company
MECO = Massachusetts Electric Company
Nant = Nantucket Electric Company
NECO = The Narragansett Electric Company
NECO Gas = Narragansett Electric Company
NGrid Serv Co = National Grid USA Service Company Inc
NIMO = Niagara Mohawk Power Corporation
Information shown in Blue represents a Transmission Function
Information shown in Red represents a Sales & Marketing Function

Last Updated 11/01/06

Engineering and Asset Management

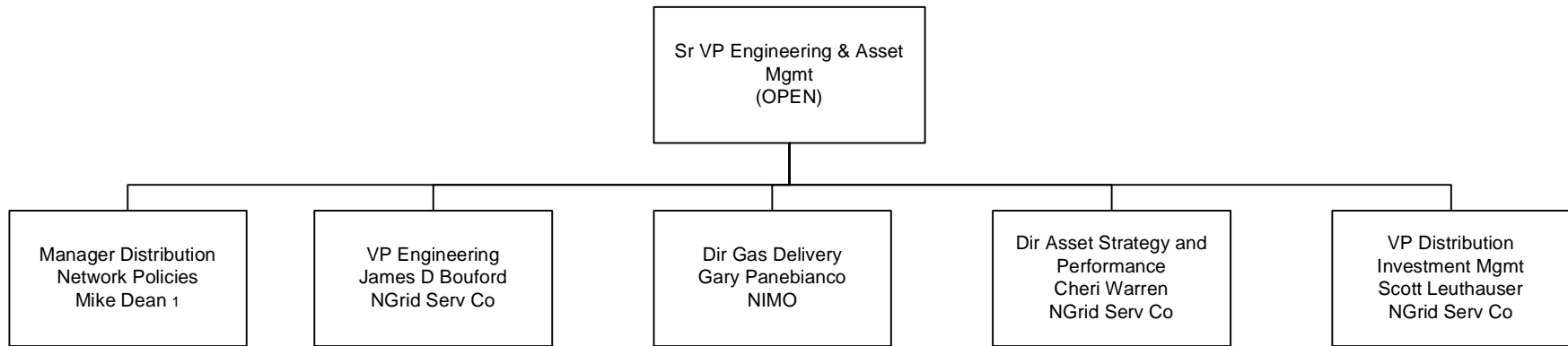

GECO = Granite State Electric Company

MECO = Massachusetts Electric Company

Nant = Nantucket Electric Company

NECO = The Narragansett Electric Company

NECO Gas = Narragansett Electric Company

NGrid Serv Co = National Grid USA Service Company Inc

NIMO = Niagara Mohawk Power Corporation

Information shown in Blue represents a Transmission Function

Information shown in Red represents a Sales & Marketing Function

Engineering Services

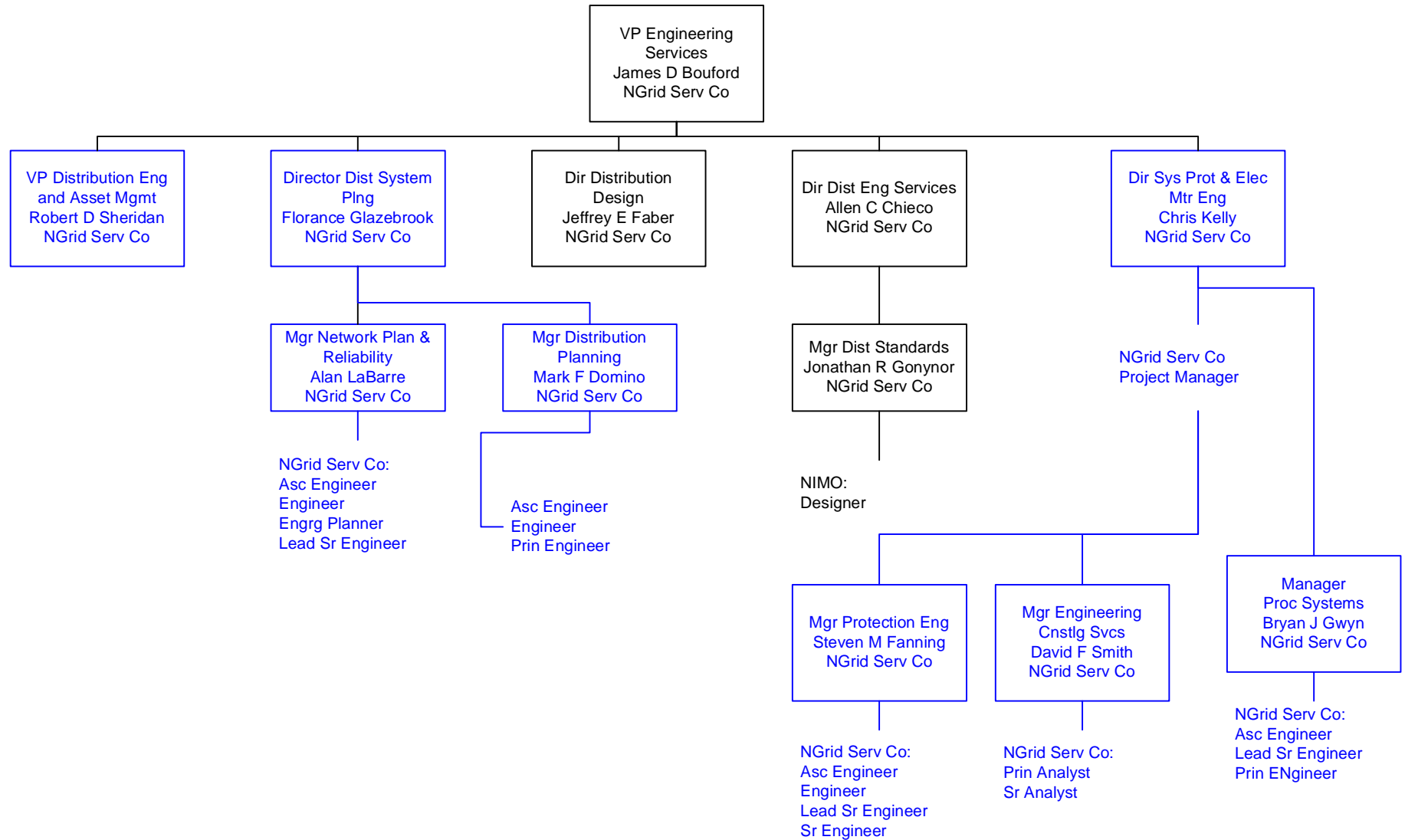

GECS = Granite State Electric Company
 MECO = Massachusetts Electric Company
 Nant = Nantucket Electric Company
 NECO = The Narragansett Electric Company
 NECO Gas = Narragansett Electric Company
 NGrid Serv Co = National Grid USA Service Company Inc
 NIMO = Niagara Mohawk Power Corporation
 Information shown in Blue represents a Transmission Function
 Information shown in Red represents a Sales & Marketing Function

Engineering Services Cont.

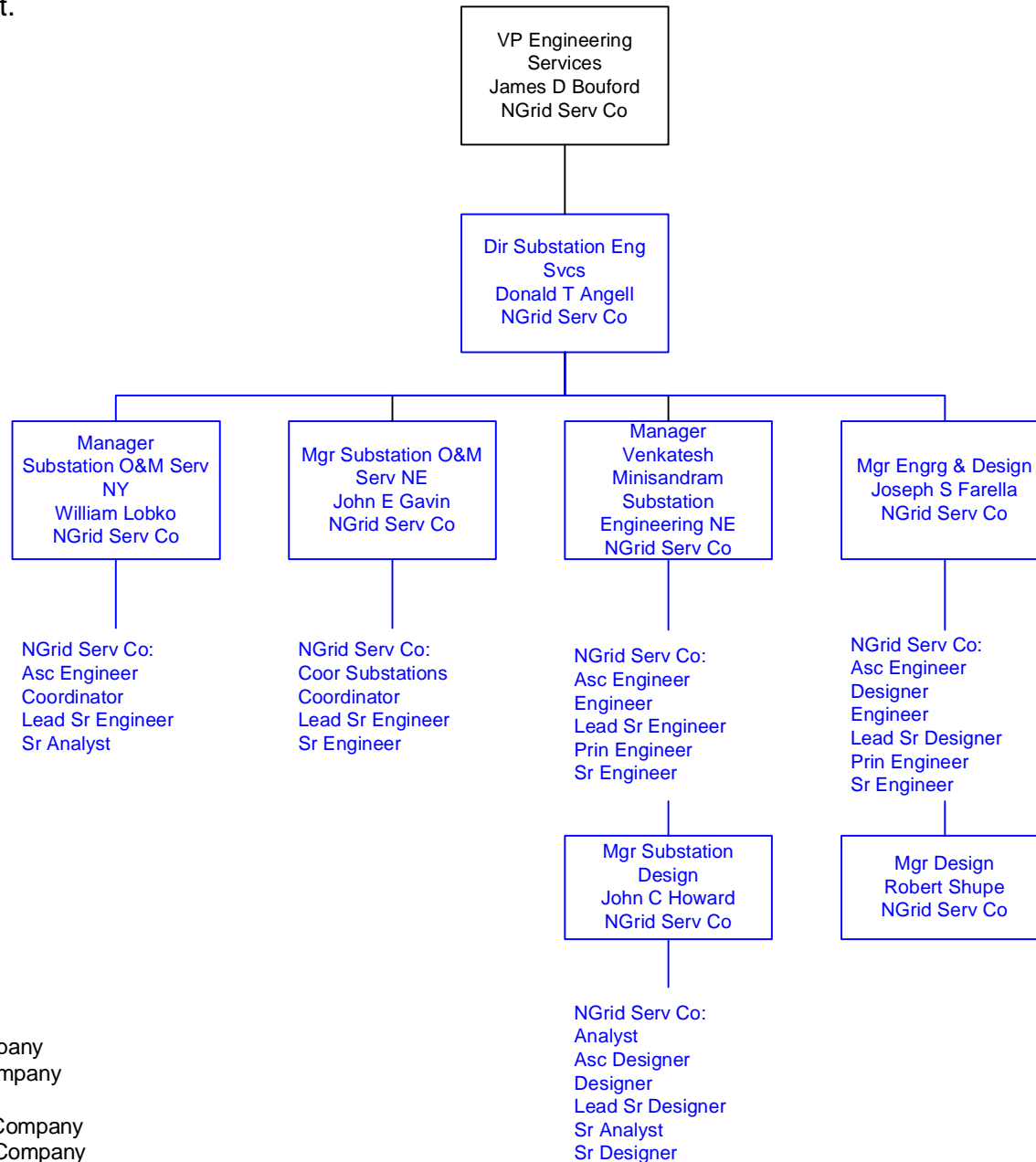

GECS = Granite State Electric Company
 MECO = Massachusetts Electric Company
 Nant = Nantucket Electric Company
 NECO = The Narragansett Electric Company
 NECO Gas = Narragansett Electric Company
 NGrid Serv Co = National Grid USA Service Company Inc
 NIMO = Niagara Mohawk Power Corporation
 Information shown in Blue represents a Transmission Function
 Information shown in Red represents a Sales & Marketing Function

Engineering and Asset Management

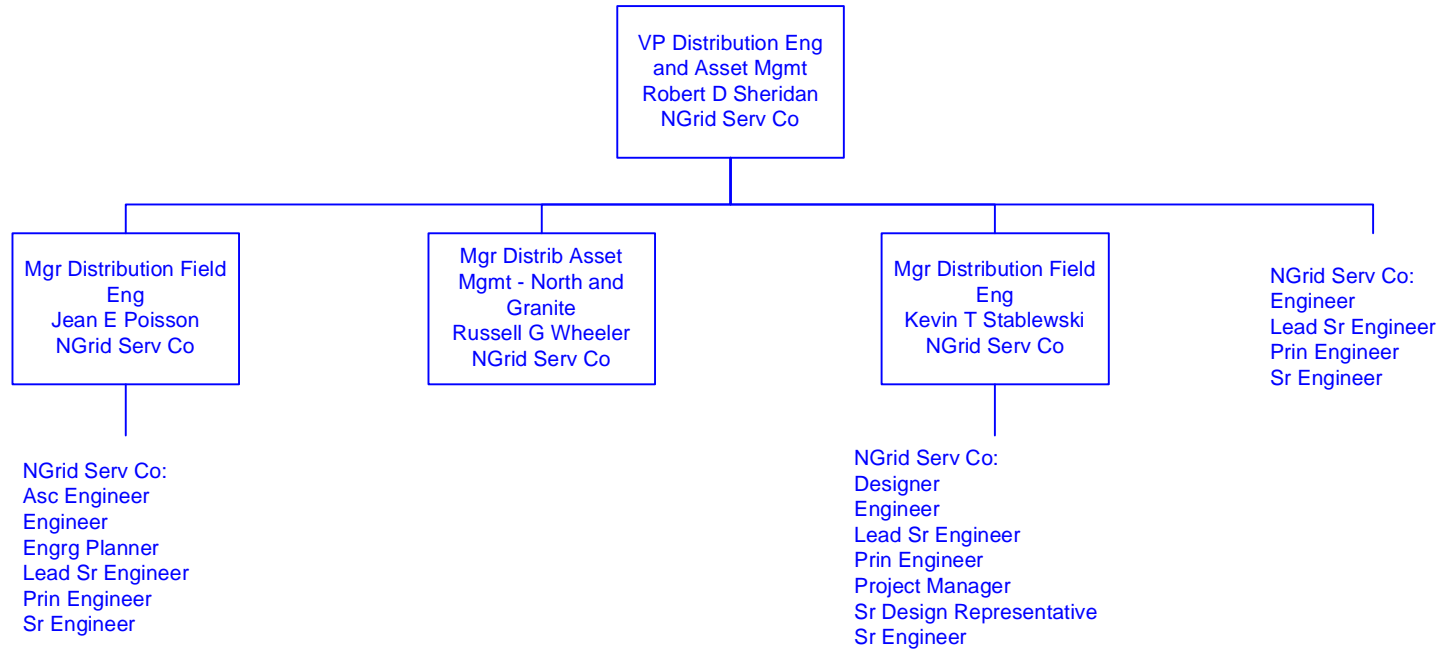

GECS = Granite State Electric Company
 MECO = Massachusetts Electric Company
 Nant = Nantucket Electric Company
 NECO = The Narragansett Electric Company
 NECO Gas = Narragansett Electric Company
 NGrid Serv Co = National Grid USA Service Company Inc
 NIMO = Niagara Mohawk Power Corporation
 Information shown in Blue represents a Transmission Function
 Information shown in Red represents a Sales & Marketing Function

Gas Distribution

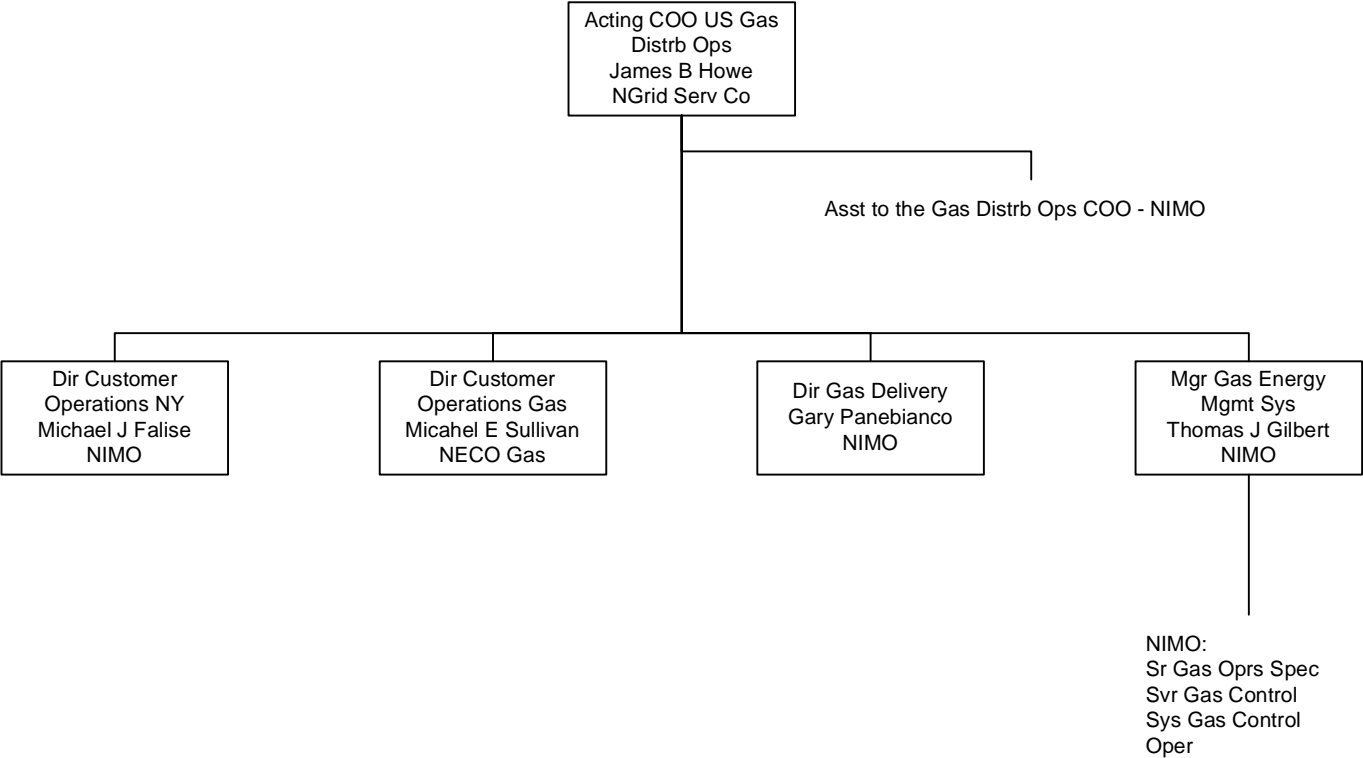

GECS = Granite State Electric Company
 MECO = Massachusetts Electric Company
 Nant = Nantucket Electric Company
 NECO = The Narragansett Electric Company
 NECO Gas = Narragansett Electric Company
 NGrid Serv Co = National Grid USA Service Company Inc
 NIMO = Niagara Mohawk Power Corporation
 Information shown in Blue represents a Transmission Function
 Information shown in Red represents a Sales & Marketing Function

Gas Delivery

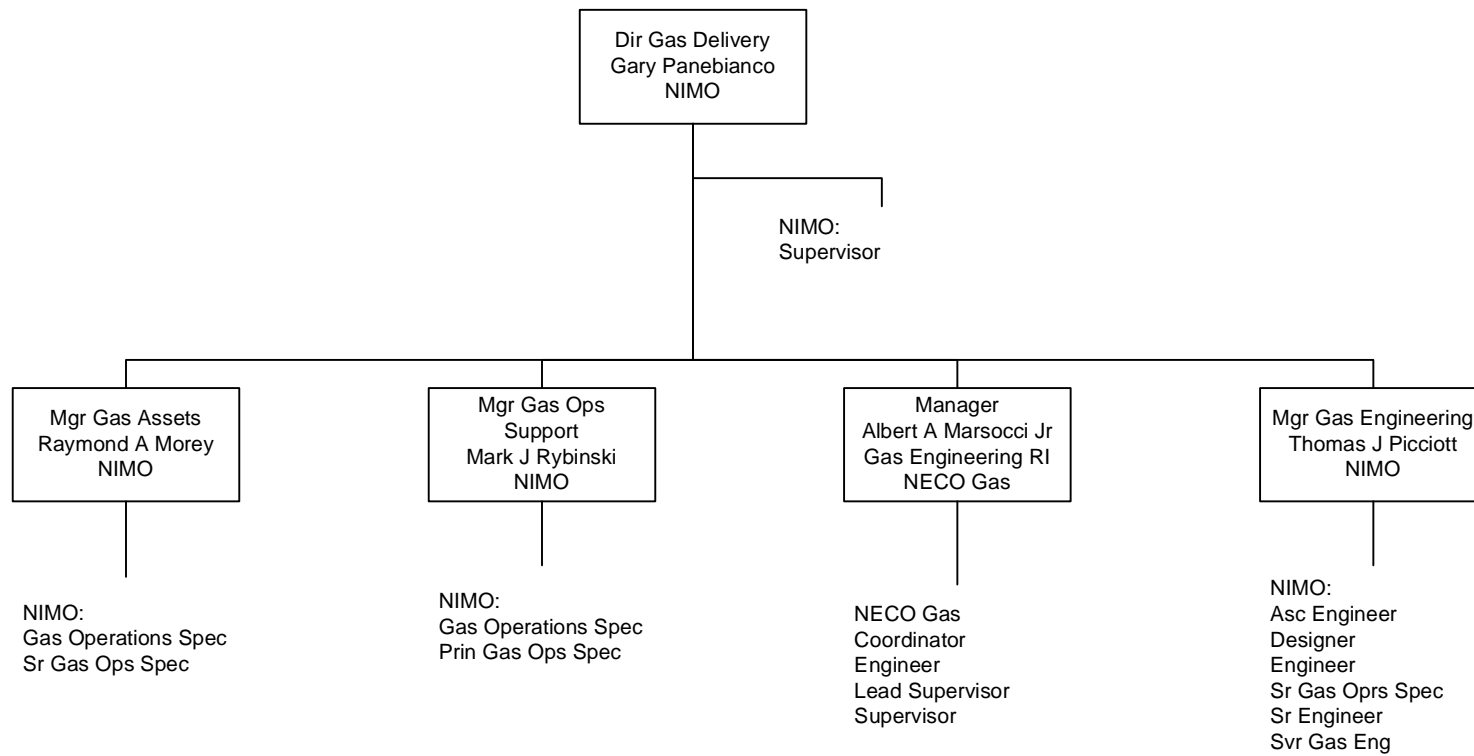

GECO = Granite State Electric Company
 MECO = Massachusetts Electric Company
 Nant = Nantucket Electric Company
 NECO = The Narragansett Electric Company
 NECO Gas = Narragansett Electric Company
 NGrid Serv Co = National Grid USA Service Company Inc
 NIMO = Niagara Mohawk Power Corporation
 Information shown in Blue represents a Transmission Function
 Information shown in Red represents a Sales & Marketing Function

New York Distribution

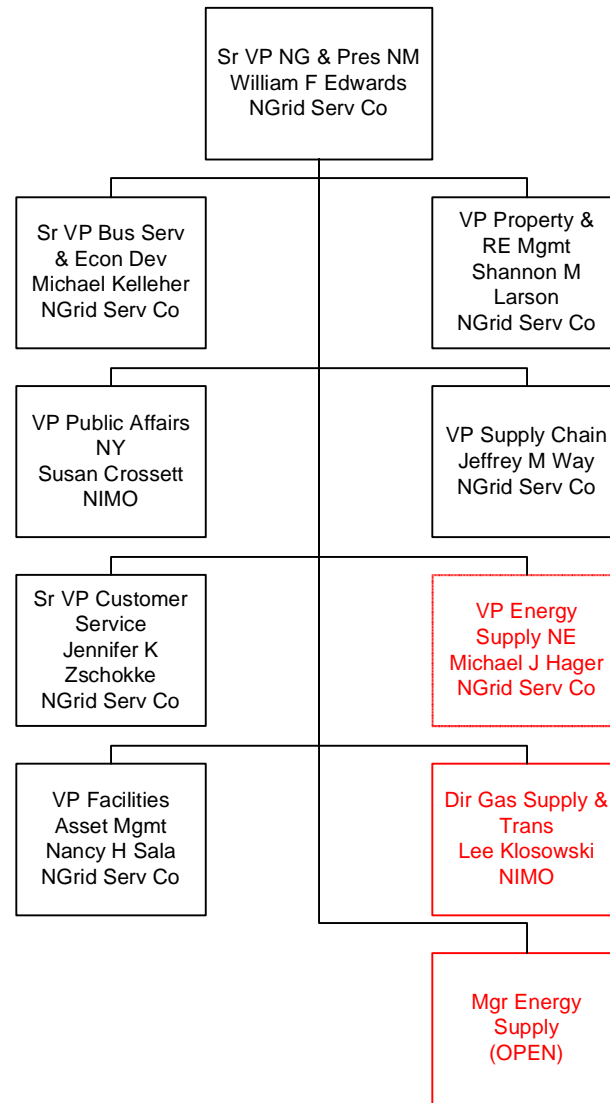

GECS = Granite State Electric Company
 MECO = Massachusetts Electric Company
 Nant = Nantucket Electric Company
 NECO = The Narragansett Electric Company
 NECO Gas = Narragansett Electric Company
 NGrid Serv Co = National Grid USA Service Company Inc
 NIMO = Niagara Mohawk Power Corporation
 Information shown in Blue represents a Transmission Function
 Information shown in Red represents a Sales & Marketing Function

Energy Supply

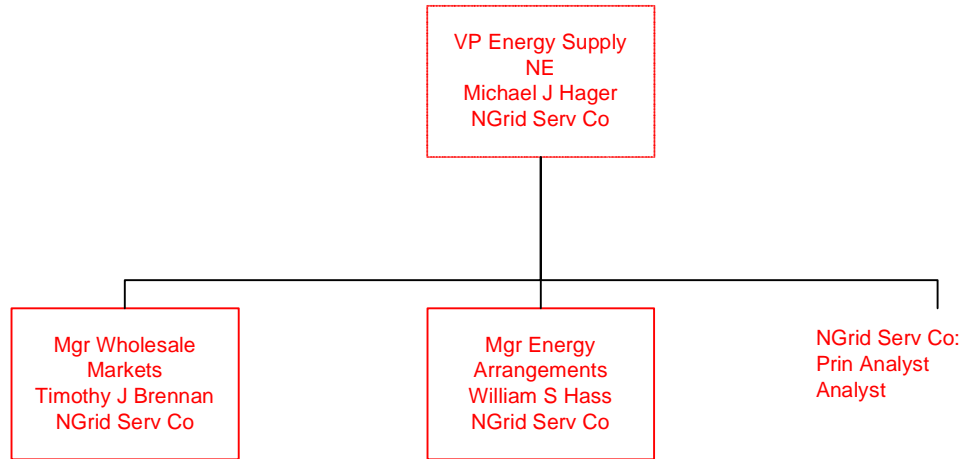

GECO = Granite State Electric Company

MECO = Massachusetts Electric Company

Nant = Nantucket Electric Company

NECO = The Narragansett Electric Company

NECO Gas = Narragansett Electric Company

NGrid Serv Co = National Grid USA Service Company Inc

NIMO = Niagara Mohawk Power Corporation

Information shown in Blue represents a Transmission Function

Information shown in Red represents a Sales & Marketing Function

Gas and Energy Supply

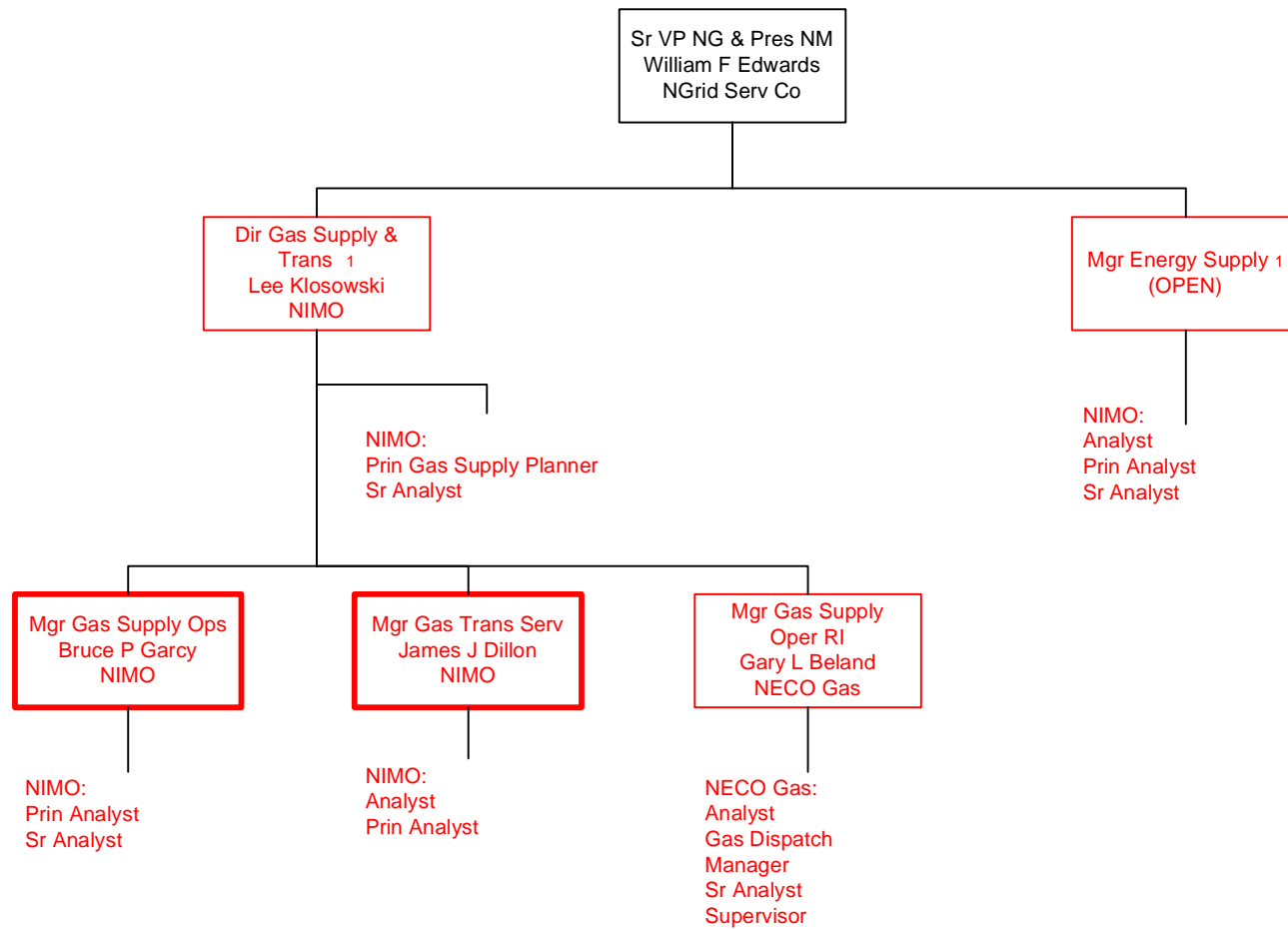

GECCO = Granite State Electric Company
 MECO = Massachusetts Electric Company
 Nant = Nantucket Electric Company
 NECO = The Narragansett Electric Company
 NECO Gas = Narragansett Electric Company
 NGrid Serv Co = National Grid USA Service Company Inc
 NIMO = Niagara Mohawk Power Corporation
 Information shown in Blue represents a Transmission Function
 Information shown in Red represents a Sales & Marketing Function

Business Services and Economic Development

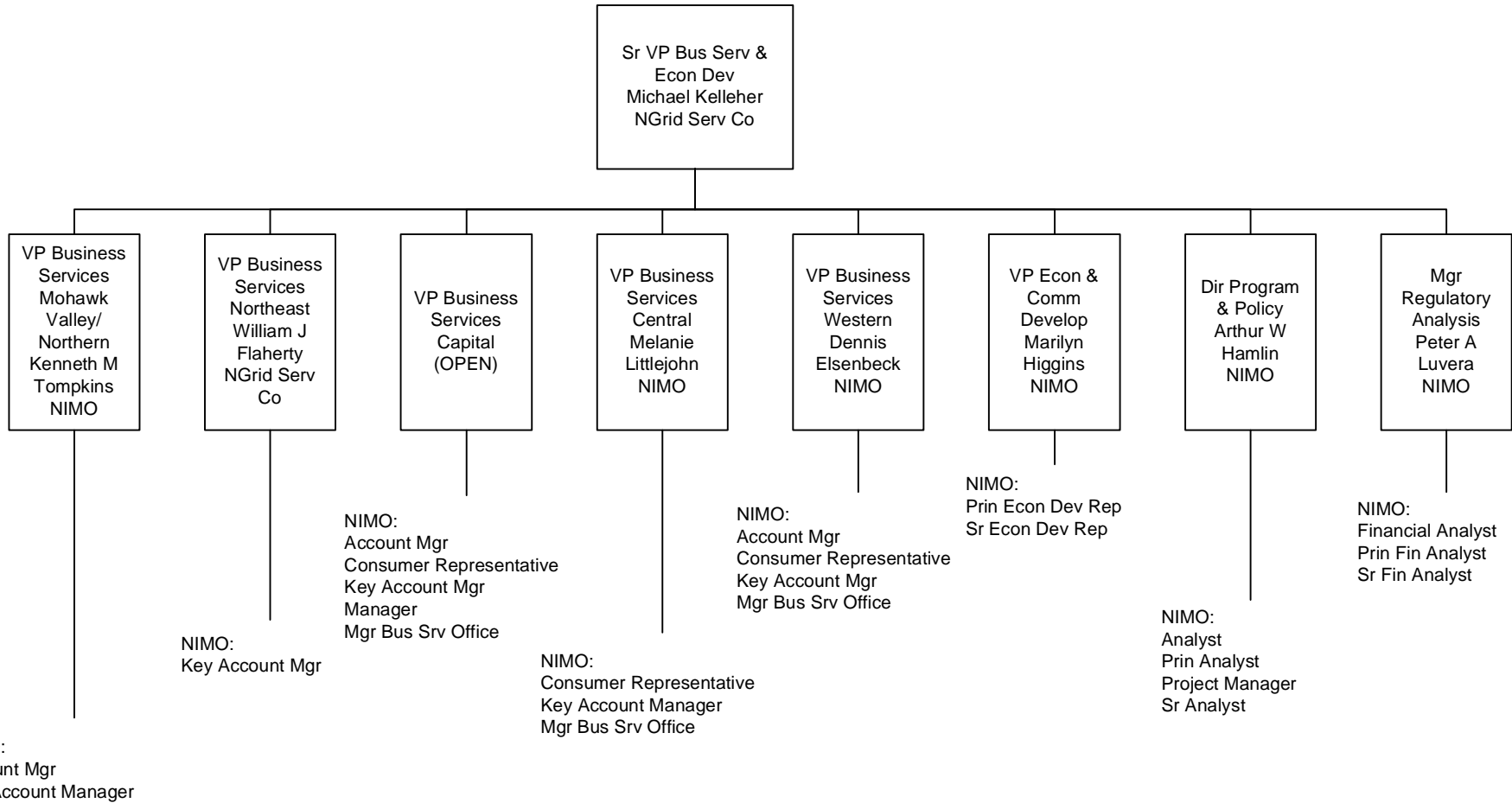

GECS = Granite State Electric Company
 MECO = Massachusetts Electric Company
 Nant = Nantucket Electric Company
 NECO = The Narragansett Electric Company
 NECO Gas = Narragansett Electric Company
 NGrid Serv Co = National Grid USA Service Company Inc
 NIMO = Niagara Mohawk Power Corporation
 Information shown in Blue represents a Transmission Function
 Information shown in Red represents a Sales & Marketing Function

Customer Service Centers

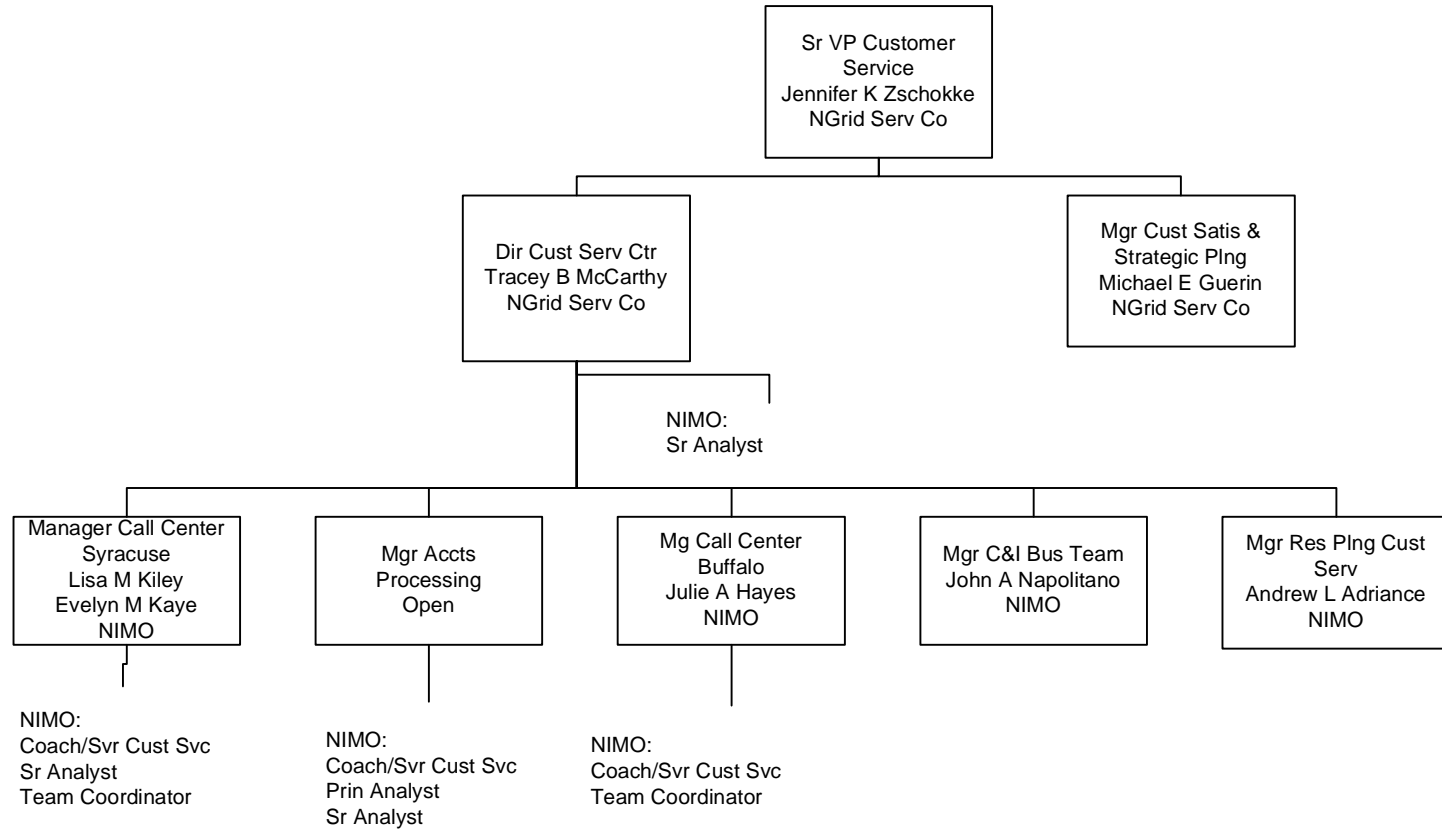

GECS = Granite State Electric Company
 MECO = Massachusetts Electric Company
 Nant = Nantucket Electric Company
 NECO = The Narragansett Electric Company
 NECO Gas = Narragansett Electric Company
 NGrid Serv Co = National Grid USA Service Company Inc
 NIMO = Niagara Mohawk Power Corporation
 Information shown in Blue represents a Transmission Function
 Information shown in Red represents a Sales & Marketing Function

Customer Service Programs

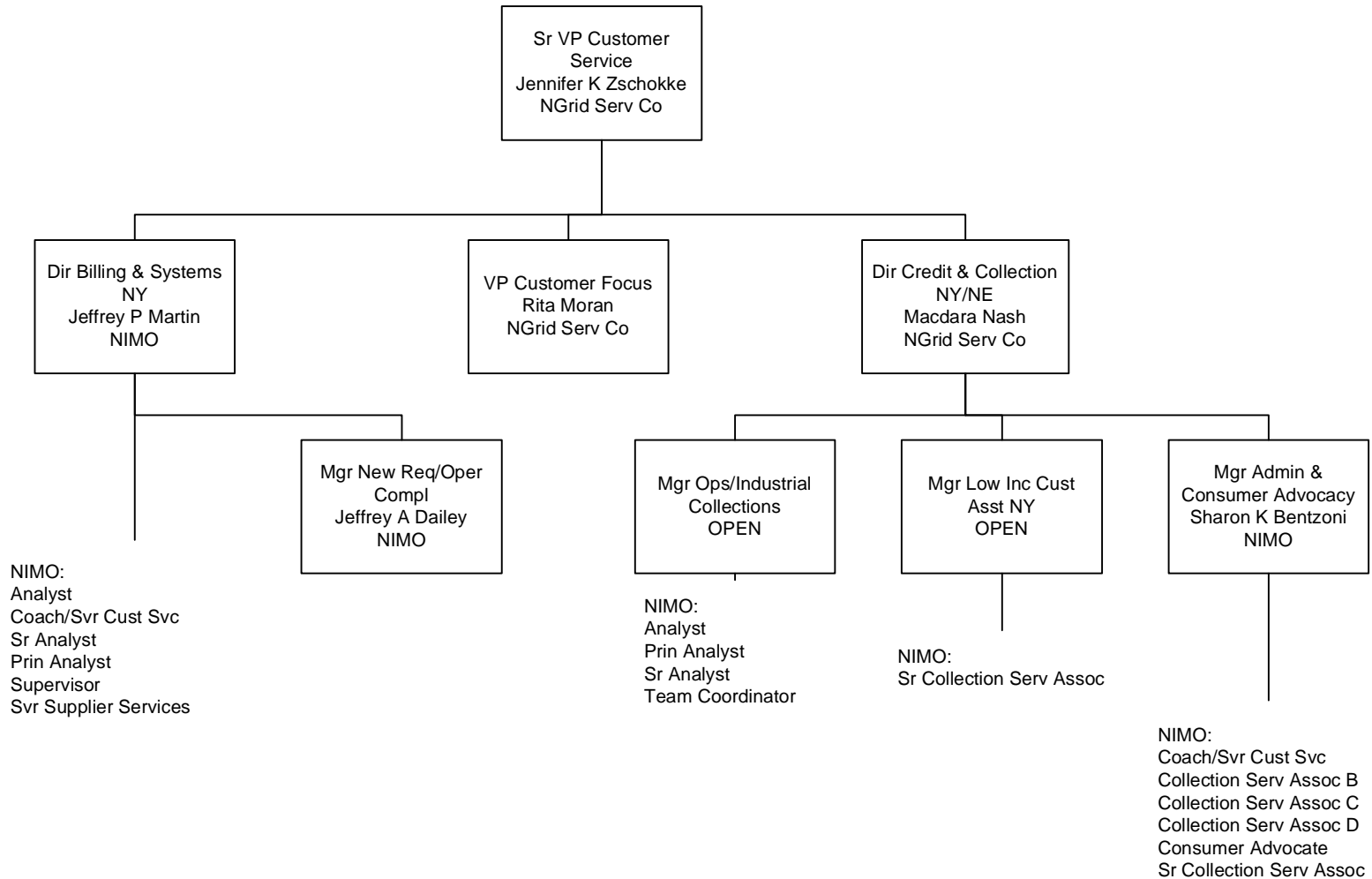

GECS = Granite State Electric Company
 MECO = Massachusetts Electric Company
 Nant = Nantucket Electric Company
 NECO = The Narragansett Electric Company
 NECO Gas = Narragansett Electric Company
 NGrid Serv Co = National Grid USA Service Company Inc
 NIMO = Niagara Mohawk Power Corporation
 Information shown in Blue represents a Transmission Function
 Information shown in Red represents a Sales & Marketing Function

Last Updated 01/09/07

Customer Satisfaction and Strategic Planning and Support

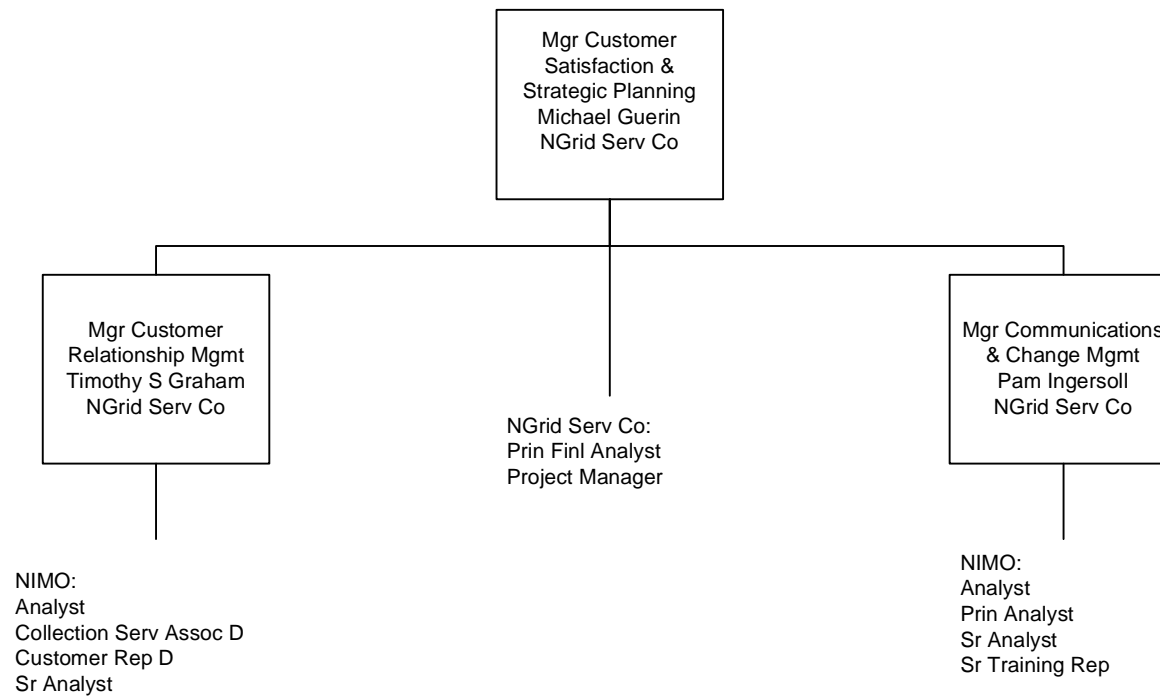

GECO = Granite State Electric Company

MECO = Massachusetts Electric Company

Nant = Nantucket Electric Company

NECO = The Narragansett Electric Company

NECO Gas = Narragansett Electric Company

NGrid Serv Co = National Grid USA Service Company Inc

NIMO = Niagara Mohawk Power Corporation

Information shown in Blue represents a Transmission Function

Information shown in Red represents a Sales & Marketing Function

Supply Chain Management

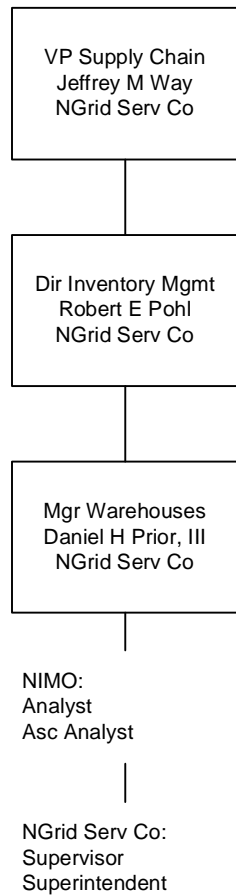

GECO = Granite State Electric Company
MECO = Massachusetts Electric Company
Nant = Nantucket Electric Company
NECO = The Narragansett Electric Company
NECO Gas = Narragansett Electric Company
NGrid Serv Co = National Grid USA Service Company Inc
NIMO = Niagara Mohawk Power Corporation
Information shown in Blue represents a Transmission Function
Information shown in Red represents a Sales & Marketing Function

Last Updated 11/01/06

Real Estate Management and Property Tax

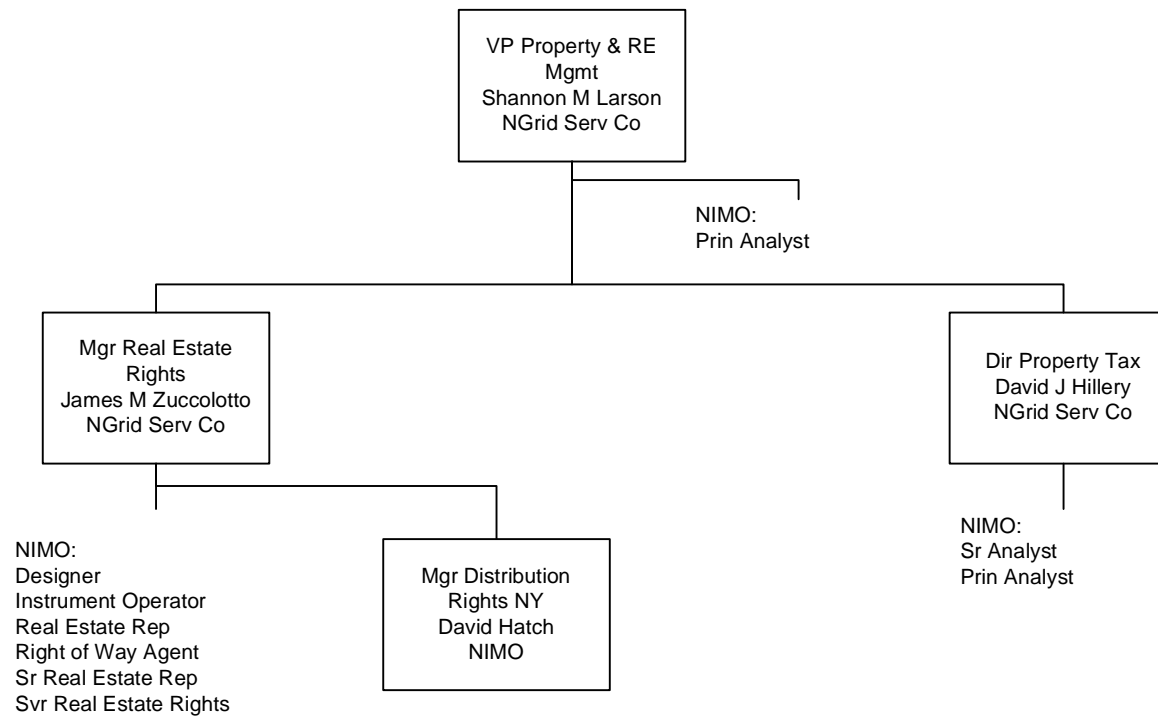

GECO = Granite State Electric Company
 MECO = Massachusetts Electric Company
 Nant = Nantucket Electric Company
 NECO = The Narragansett Electric Company
 NECO Gas = Narragansett Electric Company
 NGrid Serv Co = National Grid USA Service Company Inc
 NIMO = Niagara Mohawk Power Corporation
 Information shown in Blue represents a Transmission Function
 Information shown in Red represents a Sales & Marketing Function

Property and Real Estate Management Facilities

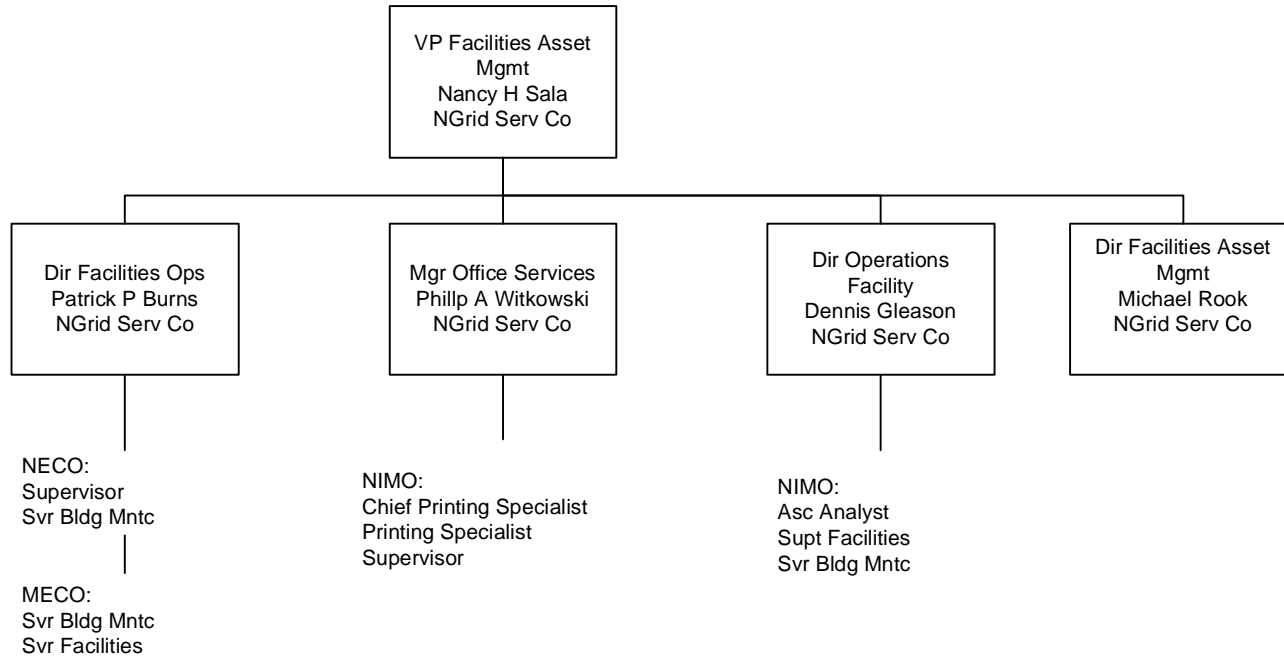

GECO = Granite State Electric Company

MECO = Massachusetts Electric Company

Nant = Nantucket Electric Company

NECO = The Narragansett Electric Company

NECO Gas = Narragansett Electric Company

NGrid Serv Co = National Grid USA Service Company Inc

NIMO = Niagara Mohawk Power Corporation

Information shown in Blue represents a Transmission Function

Information shown in Red represents a Sales & Marketing Function

Last Updated 11/01/06

Safety & Health, Envir, Security

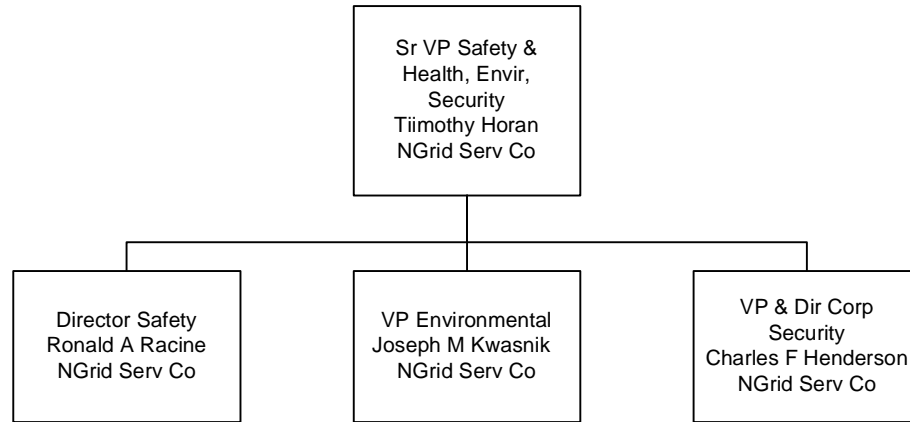

GECO = Granite State Electric Company

MECO = Massachusetts Electric Company

Nant = Nantucket Electric Company

NECO = The Narragansett Electric Company

NECO Gas = Narragansett Electric Company

NGrid Serv Co = National Grid USA Service Company Inc

NIMO = Niagara Mohawk Power Corporation

Information shown in Blue represents a Transmission Function

Information shown in Red represents a Sales & Marketing Function

Environmental

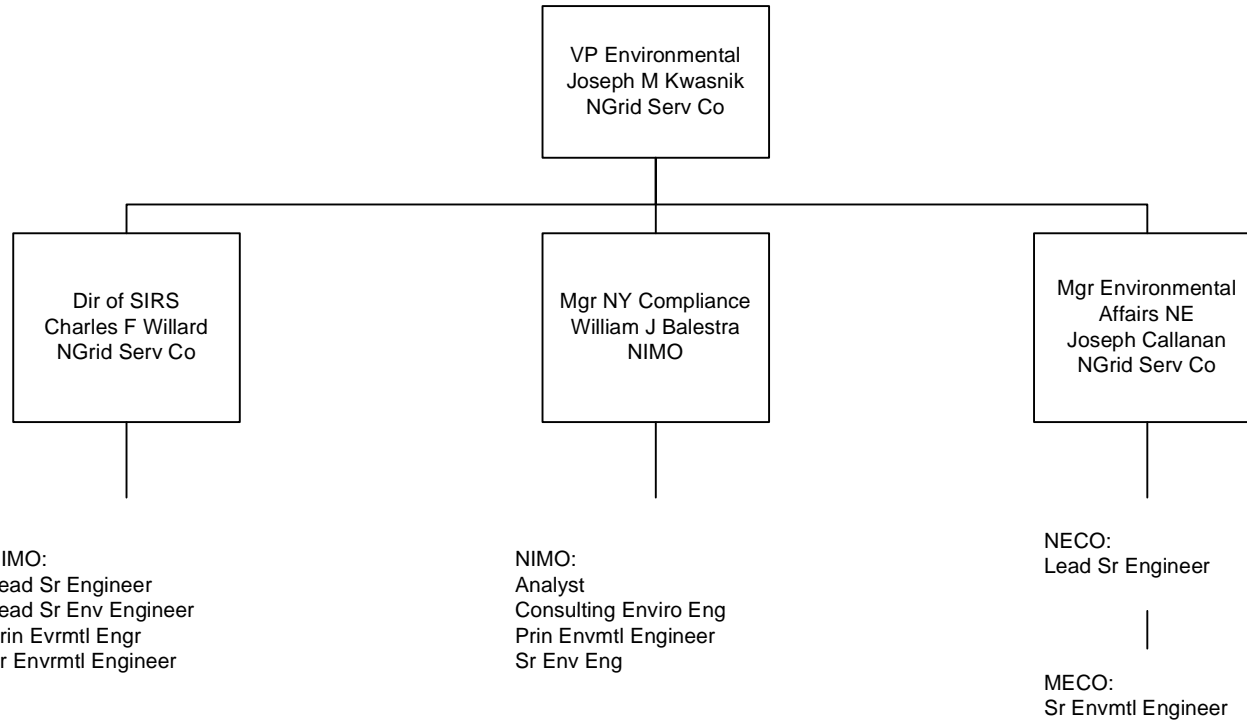

GECO = Granite State Electric Company
 MECO = Massachusetts Electric Company
 Nant = Nantucket Electric Company
 NECO = The Narragansett Electric Company
 NECO Gas = Narragansett Electric Company
 NGrid Serv Co = National Grid USA Service Company Inc
 NIMO = Niagara Mohawk Power Corporation
 Information shown in Blue represents a Transmission Function
 Information shown in Red represents a Sales & Marketing Function

Information Technology

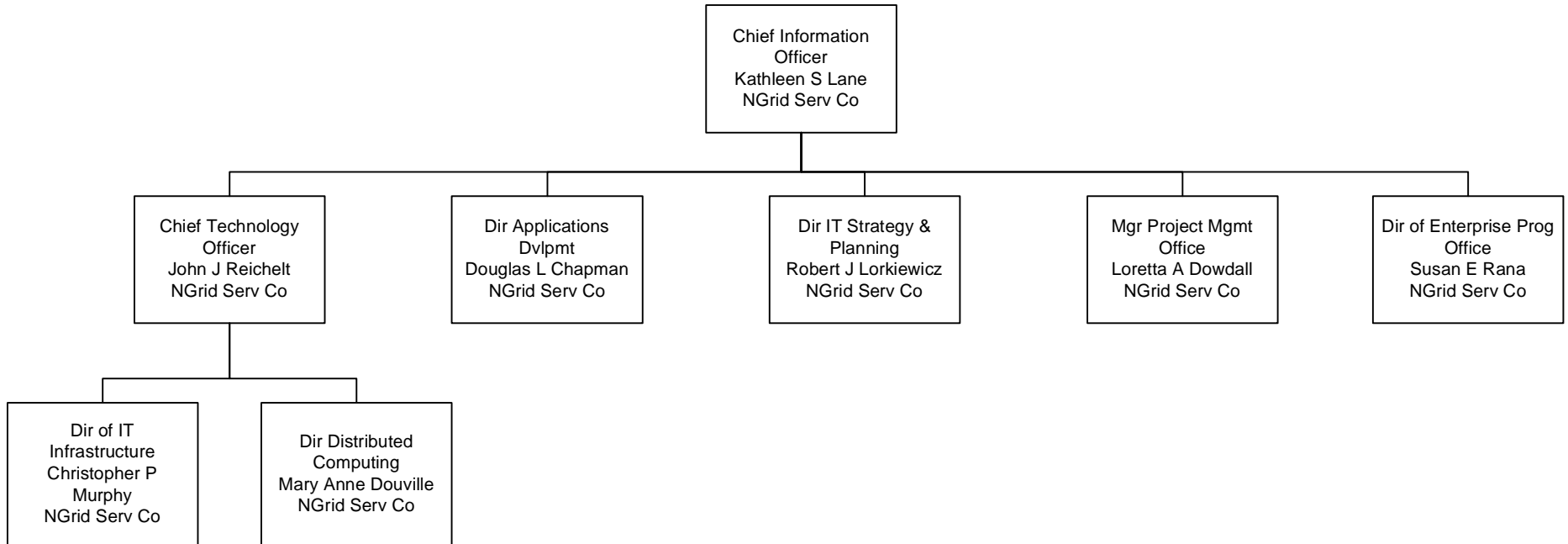

GECS = Granite State Electric Company
 MECO = Massachusetts Electric Company
 Nant = Nantucket Electric Company
 NECO = The Narragansett Electric Company
 NECO Gas = Narragansett Electric Company
 NGrid Serv Co = National Grid USA Service Company Inc
 NIMO = Niagara Mohawk Power Corporation
 Information shown in Blue represents a Transmission Function
 Information shown in Red represents a Sales & Marketing Function

Information Technology Application Development

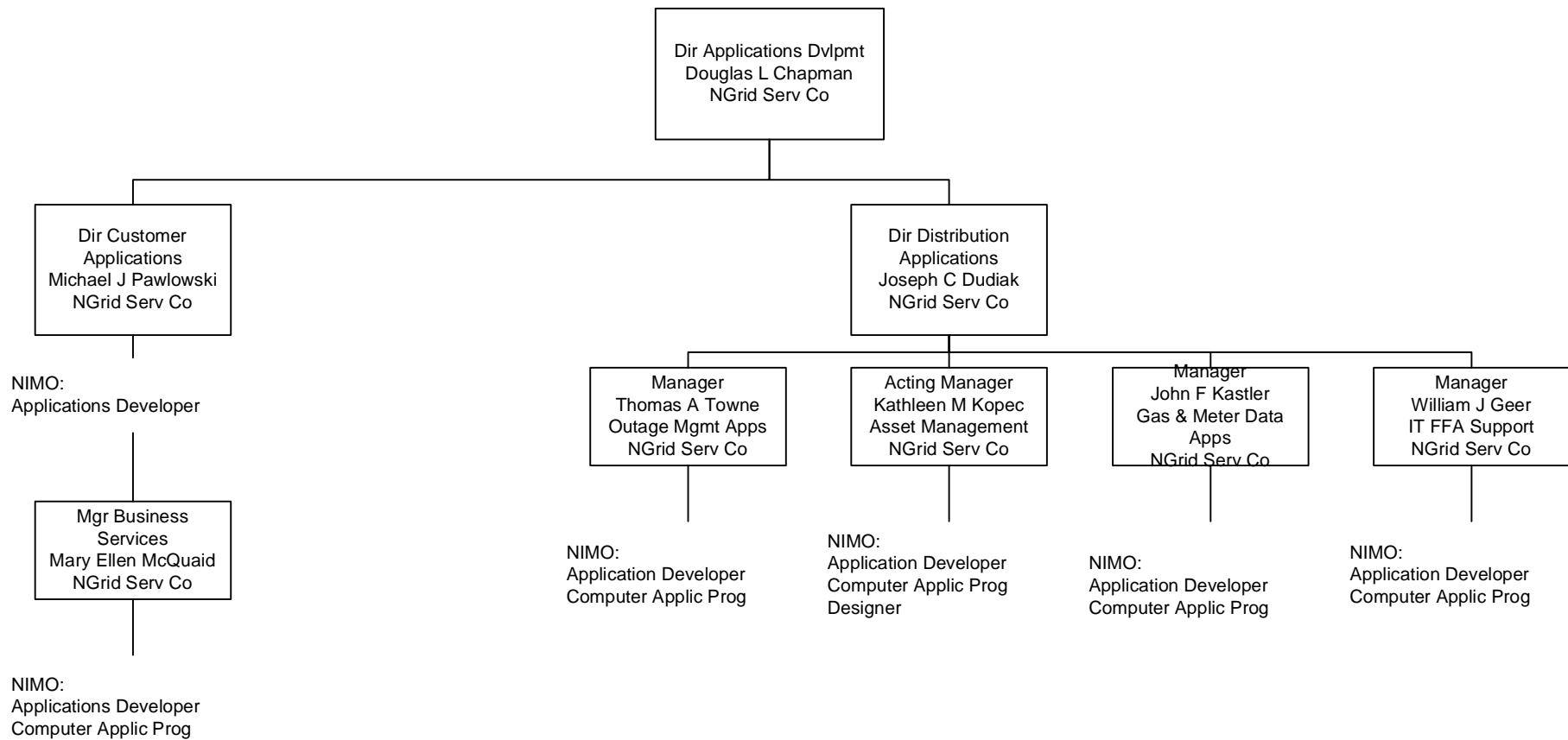

GECS = Granite State Electric Company
 MECO = Massachusetts Electric Company
 Nant = Nantucket Electric Company
 NECO = The Narragansett Electric Company
 NECO Gas = Narragansett Electric Company
 NGrid Serv Co = National Grid USA Service Company Inc
 NIMO = Niagara Mohawk Power Corporation
 Information shown in Blue represents a Transmission Function
 Information shown in Red represents a Sales & Marketing Function

Information Technology Infrastructure

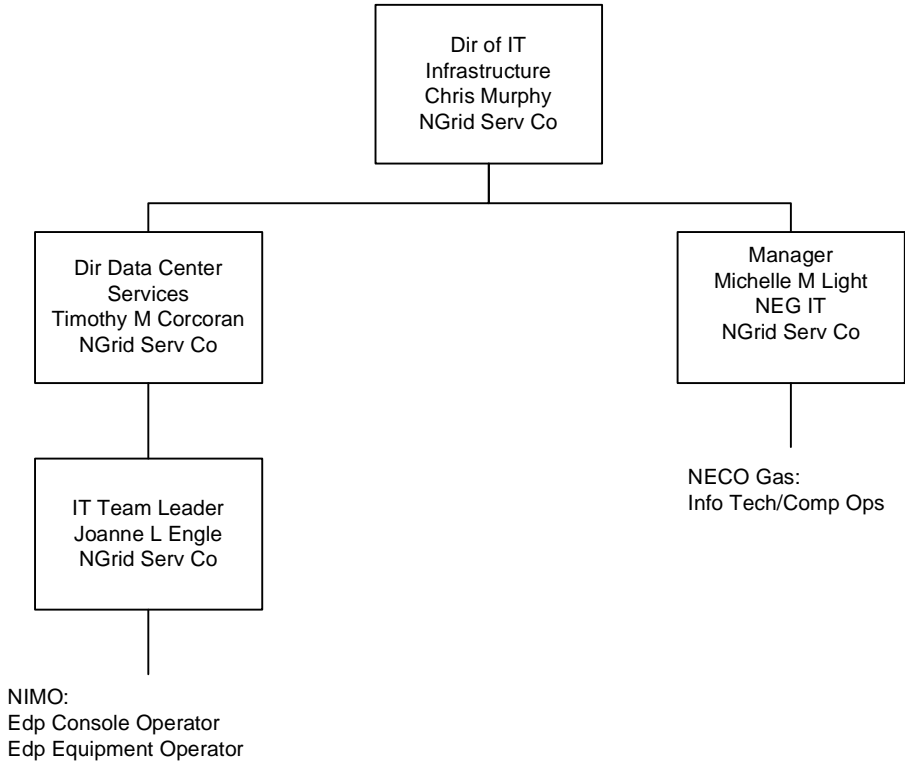

GECCO = Granite State Electric Company
 MECO = Massachusetts Electric Company
 Nant = Nantucket Electric Company
 NECO = The Narragansett Electric Company
 NECO Gas = Narragansett Electric Company
 NGrid Serv Co = National Grid USA Service Company Inc
 NIMO = Niagara Mohawk Power Corporation
 Information shown in Blue represents a Transmission Function
 Information shown in Red represents a Sales & Marketing Function

Business Development

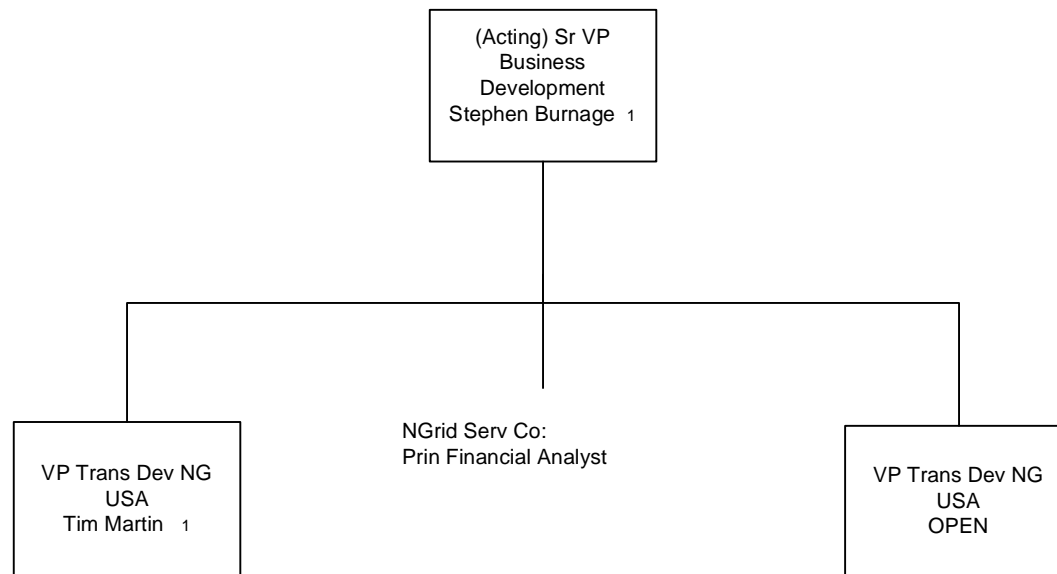

GECO = Granite State Electric Company

MECO = Massachusetts Electric Company

Nant = Nantucket Electric Company

NECO = The Narragansett Electric Company

NECO Gas = Narragansett Electric Company

NGrid Serv Co = National Grid USA Service Company Inc

NIMO = Niagara Mohawk Power Corporation

Information shown in Blue represents a Transmission Function

Information shown in Red represents a Sales & Marketing Function

Mergers and Aquisitions

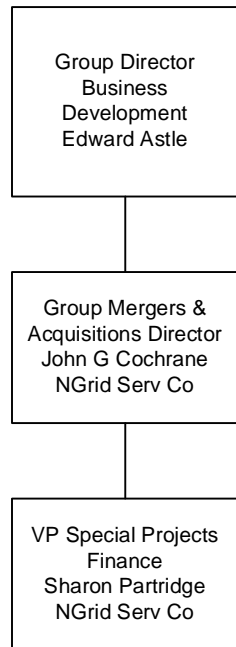

GECO = Granite State Electric Company

MECO = Massachusetts Electric Company

Nant = Nantucket Electric Company

NECO = The Narragansett Electric Company

NECO Gas = Narragansett Electric Company

NGrid Serv Co = National Grid USA Service Company Inc

NIMO = Niagara Mohawk Power Corporation

Information shown in Blue represents a Transmission Function

Information shown in Red represents a Sales & Marketing Function

Finance - CFO

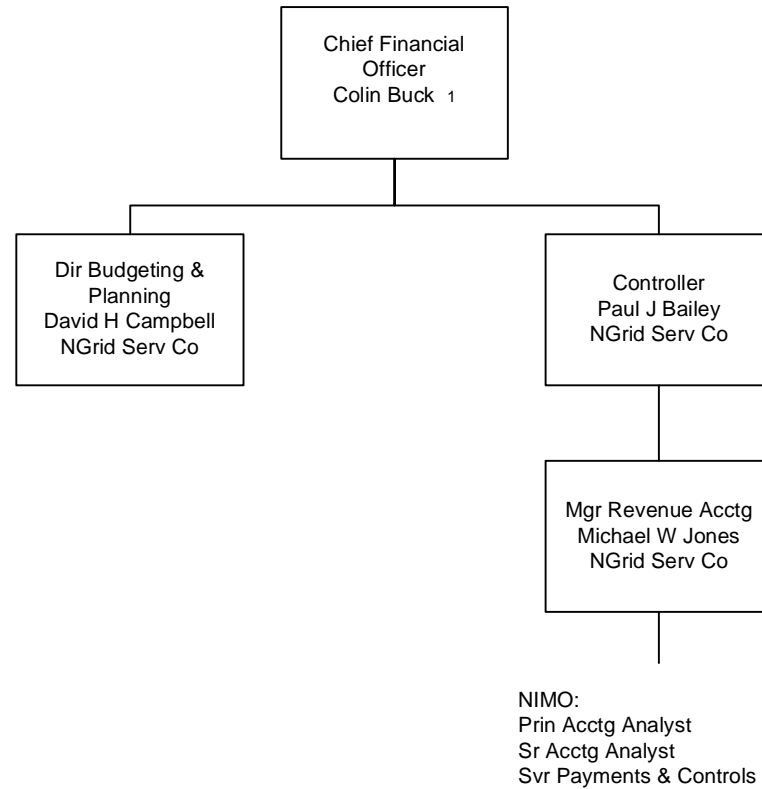

GECO = Granite State Electric Company
MECO = Massachusetts Electric Company
Nant = Nantucket Electric Company
NECO = The Narragansett Electric Company
NECO Gas = Narragansett Electric Company
NGrid Serv Co = National Grid USA Service Company Inc
NIMO = Niagara Mohawk Power Corporation
Information shown in Blue represents a Transmission Function
Information shown in Red represents a Sales & Marketing Function

Finance

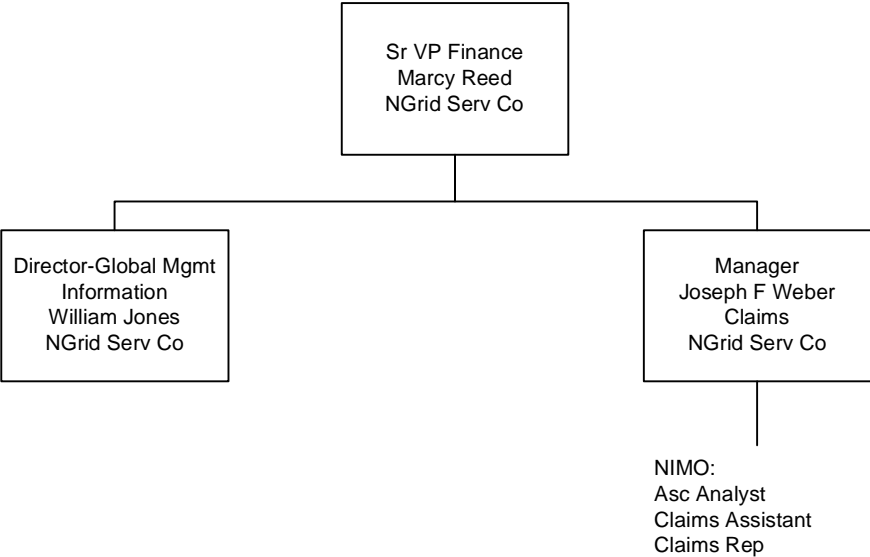

GECO = Granite State Electric Company
MECO = Massachusetts Electric Company
Nant = Nantucket Electric Company
NECO = The Narragansett Electric Company
NECO Gas = Narragansett Electric Company
NGrid Serv Co = National Grid USA Service Company Inc
NIMO = Niagara Mohawk Power Corporation
Information shown in Blue represents a Transmission Function
Information shown in Red represents a Sales & Marketing Function

Last Updated 12/11/06

Human Resources

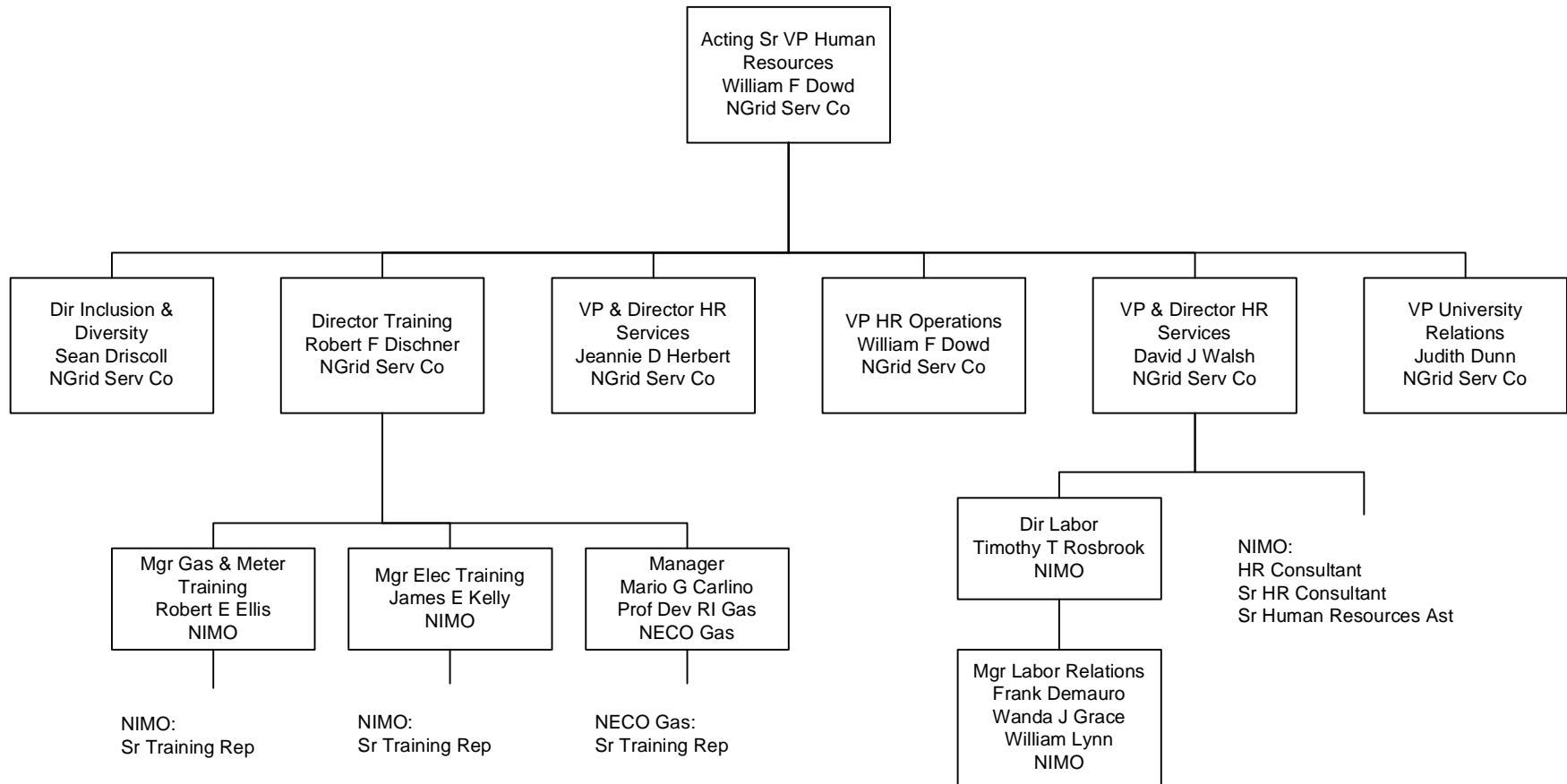

GECCO = Granite State Electric Company
 MECO = Massachusetts Electric Company
 Nant = Nantucket Electric Company
 NECO = The Narragansett Electric Company
 NECO Gas = Narragansett Electric Company
 NGrid Serv Co = National Grid USA Service Company Inc
 NIMO = Niagara Mohawk Power Corporation
 Information shown in Blue represents a Transmission Function
 Information shown in Red represents a Sales & Marketing Function

Legal

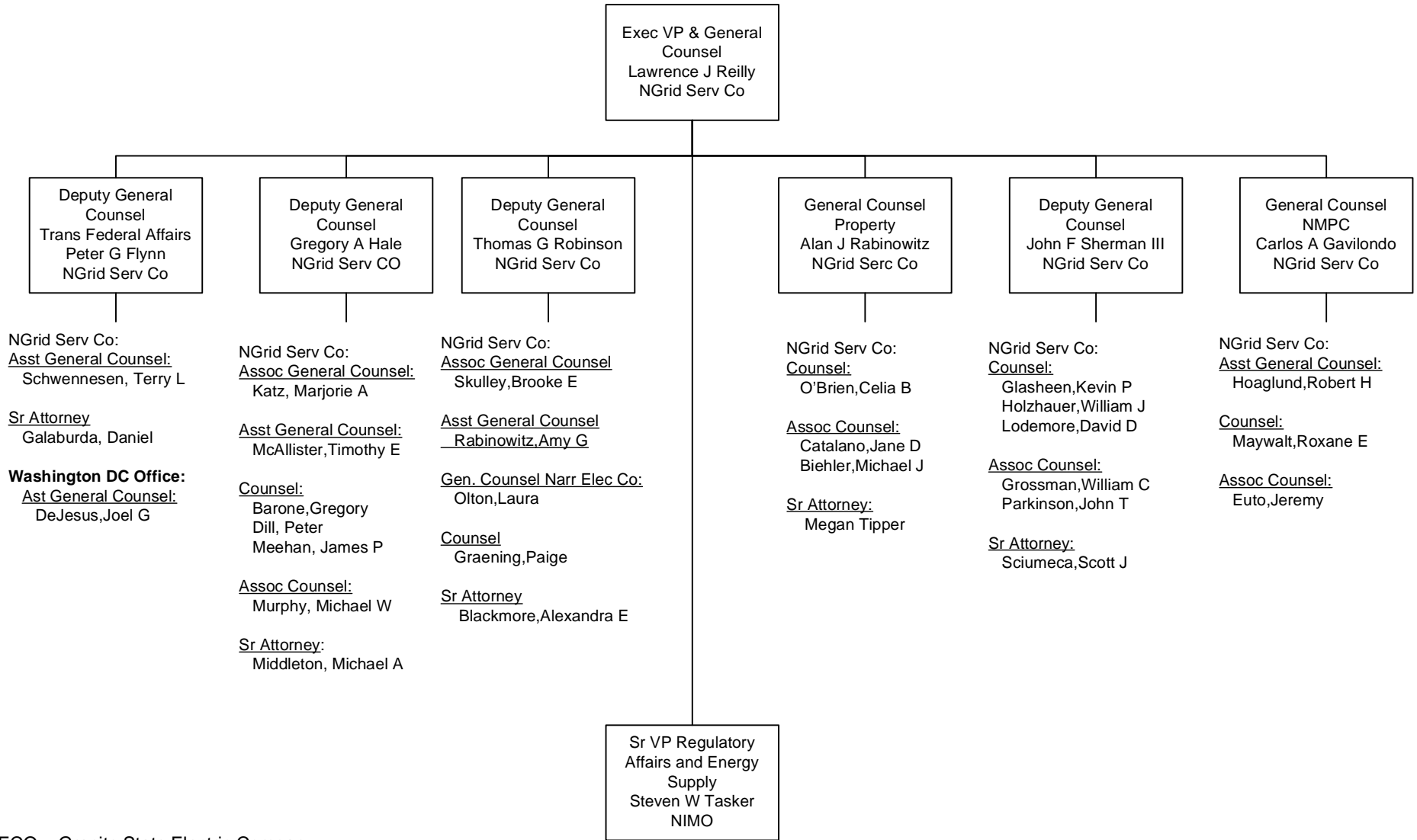

GECO = Granite State Electric Company
 MECO = Massachusetts Electric Company
 Nant = Nantucket Electric Company
 NECO = The Narragansett Electric Company
 NECO Gas = Narragansett Electric Company
 NGrid Serv Co = National Grid USA Service Company Inc
 NIMO = Niagara Mohawk Power Corporation
 Information shown in Blue represents a Transmission Function
 Information shown in Red represents a Sales & Marketing Function

Last Updated 02/27/07

Legal and External Relations

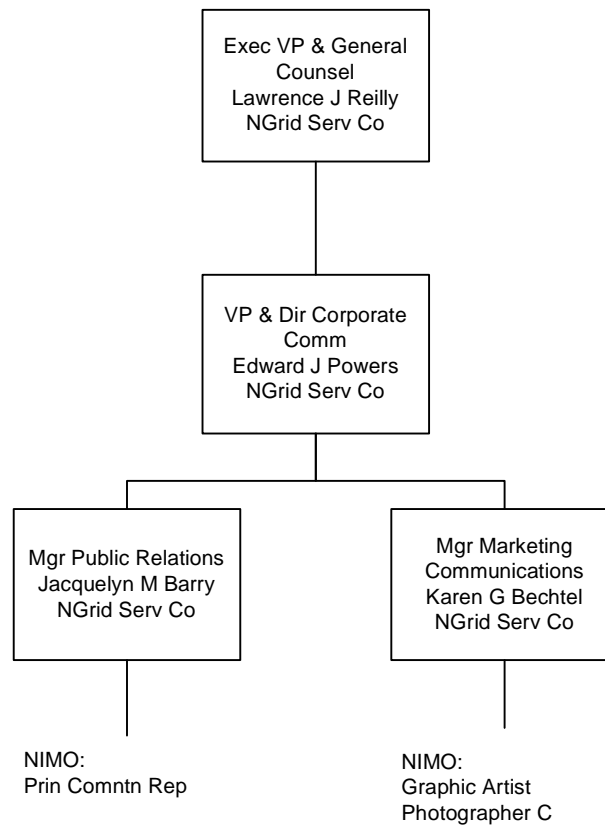

GECO = Granite State Electric Company

MECO = Massachusetts Electric Company

Nant = Nantucket Electric Company

NECO = The Narragansett Electric Company

NECO Gas = Narragansett Electric Company

NGrid Serv Co = National Grid USA Service Company Inc

NIMO = Niagara Mohawk Power Corporation

Information shown in Blue represents a Transmission Function

Information shown in Red represents a Sales & Marketing Function

Last Updated 03/09/07

New York Regulatory Affairs

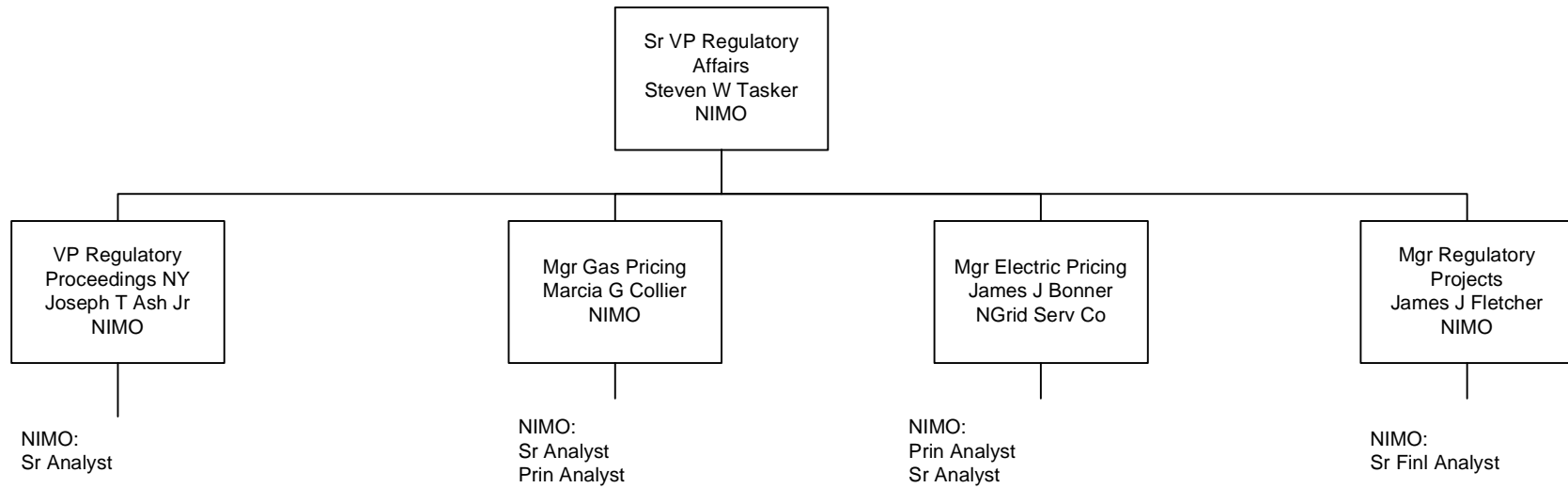

GECO = Granite State Electric Company

MECO = Massachusetts Electric Company

Nant = Nantucket Electric Company

NECO = The Narragansett Electric Company

NECO Gas = Narragansett Electric Company

NGrid Serv Co = National Grid USA Service Company Inc

NIMO = Niagara Mohawk Power Corporation

Information shown in Blue represents a Transmission Function

Information shown in Red represents a Sales & Marketing Function

Last Updated 11/28/06