

GECO = Granite State Electric Company
MECO = Massachusetts Electric Company
Nant = Nantucket Electric Company
NECO = The Narragansett Electric Company
NECO Gas = Narragansett Electric Company
NGrid Serv Co = National Grid USA Service Company Inc
NIMO = Niagara Mohawk Power Corporation
Information shown in Blue represents a Transmission Function
Information shown in Red represents a Sales & Marketing Function
Information shown in blue represents a Transmission Function

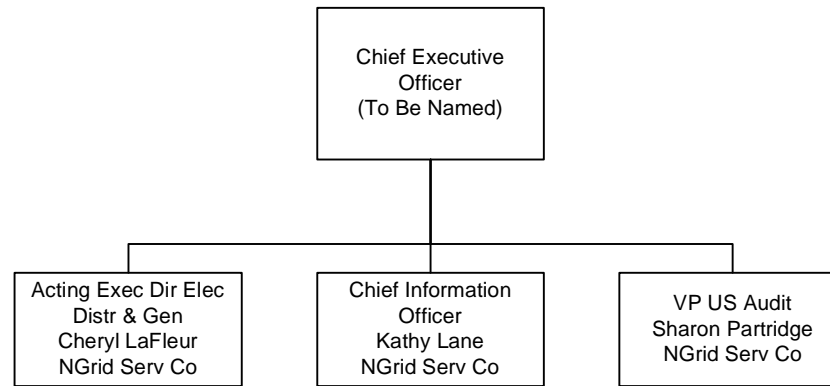

GECO = Granite State Electric Company
MECO = Massachusetts Electric Company
Nant = Nantucket Electric Company
NECO = The Narragansett Electric Company
NECO Gas = Narragansett Electric Company
NGrid Serv Co = National Grid USA Service Company Inc
NIMO = Niagara Mohawk Power Corporation
Information shown in Blue represents a Transmission Function
Information shown in Red represents a Sales & Marketing Function

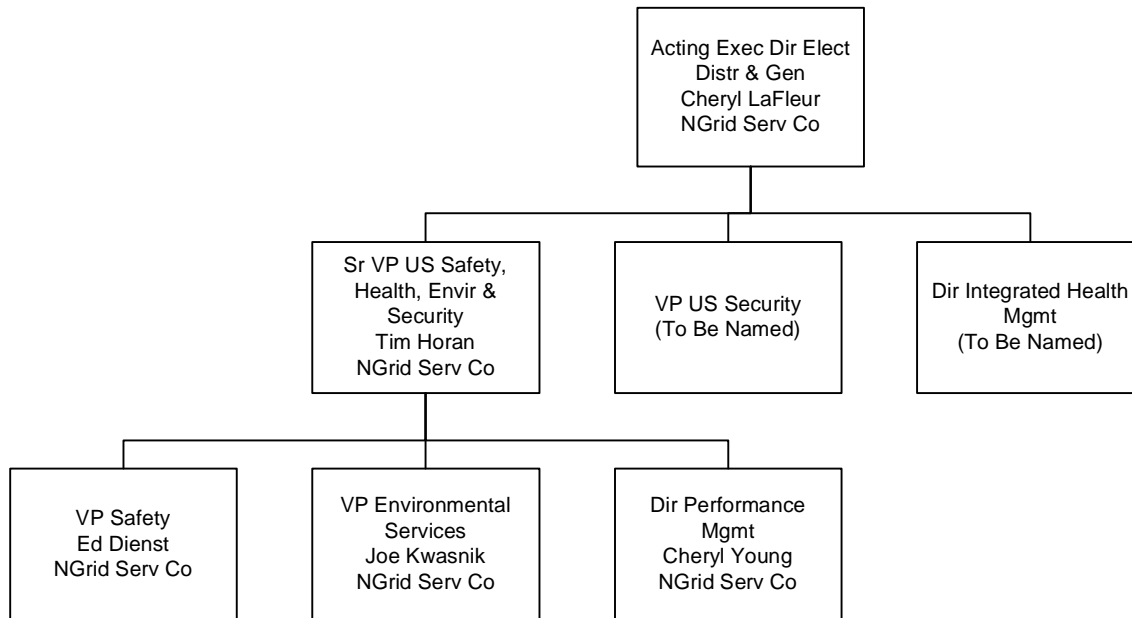

GECCO = Granite State Electric Company
 MECO = Massachusetts Electric Company
 Nant = Nantucket Electric Company
 NECO = The Narragansett Electric Company
 NECO Gas = Narragansett Electric Company
 NGrid Serv Co = National Grid USA Service Company Inc
 NIMO = Niagara Mohawk Power Corporation
 Information shown in Blue represents a Transmission Function
 Information shown in Red represents a Sales & Marketing Function

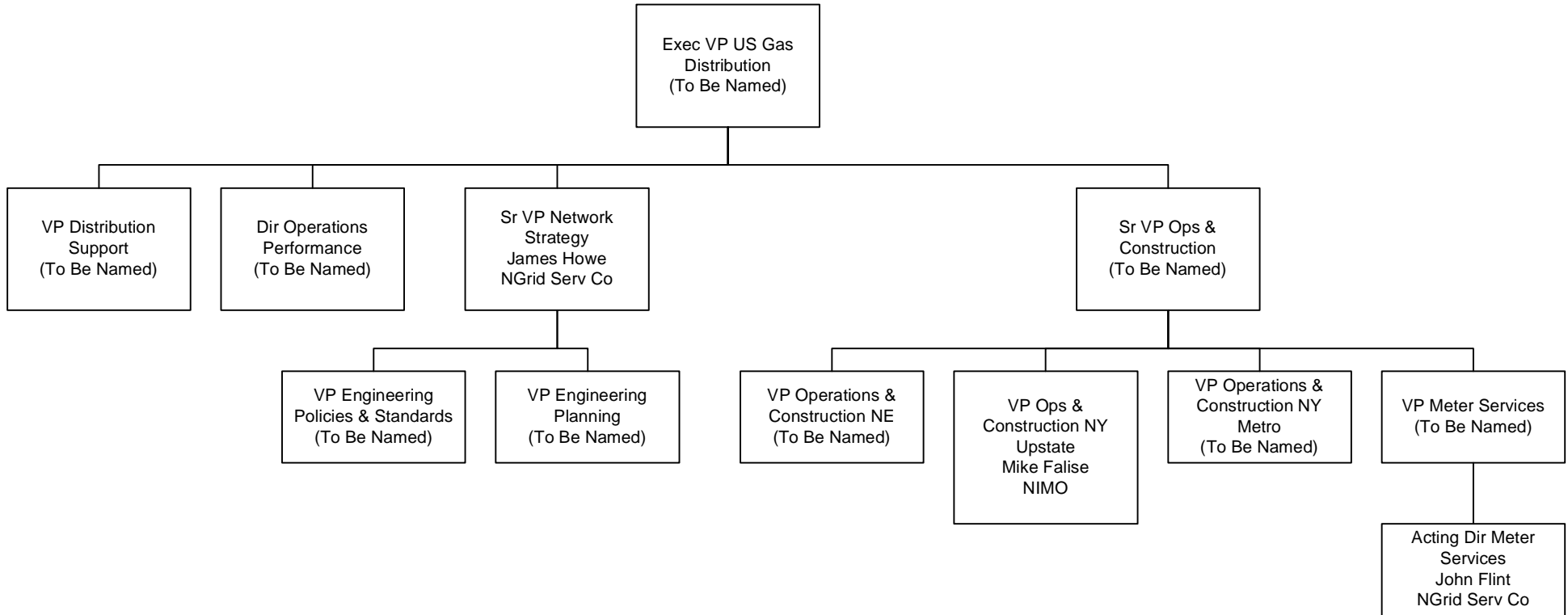

GECCO = Granite State Electric Company
 MECO = Massachusetts Electric Company
 Nant = Nantucket Electric Company
 NECO = The Narragansett Electric Company
 NECO Gas = Narragansett Electric Company
 NGrid Serv Co = National Grid USA Service Company Inc
 NIMO = Niagara Mohawk Power Corporation
 Information shown in Blue represents a Transmission Function
 Information shown in Red represents a Sales & Marketing Function

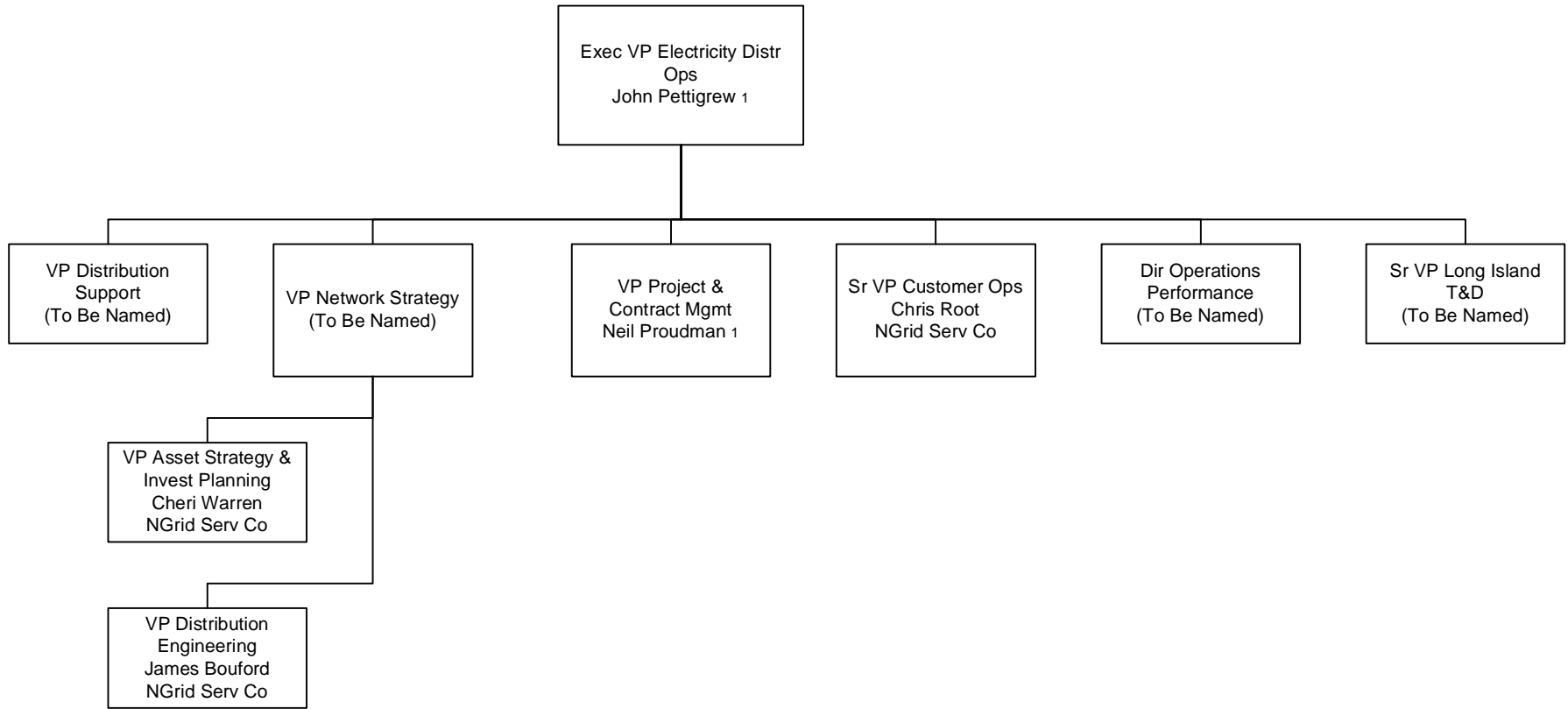

GECCO = Granite State Electric Company
 MECO = Massachusetts Electric Company
 Nant = Nantucket Electric Company
 NECO = The Narragansett Electric Company
 NECO Gas = Narragansett Electric Company
 NGrid Serv Co = National Grid USA Service Company Inc
 NIMO = Niagara Mohawk Power Corporation
 Information shown in Blue represents a Transmission Function
 Information shown in Red represents a Sales & Marketing Function

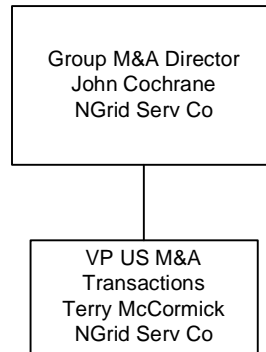

GECO = Granite State Electric Company
MECO = Massachusetts Electric Company
Nant = Nantucket Electric Company
NECO = The Narragansett Electric Company
NECO Gas = Narragansett Electric Company
NGrid Serv Co = National Grid USA Service Company Inc
NIMO = Niagara Mohawk Power Corporation
Information shown in Blue represents a Transmission Function
Information shown in Red represents a Sales & Marketing Function

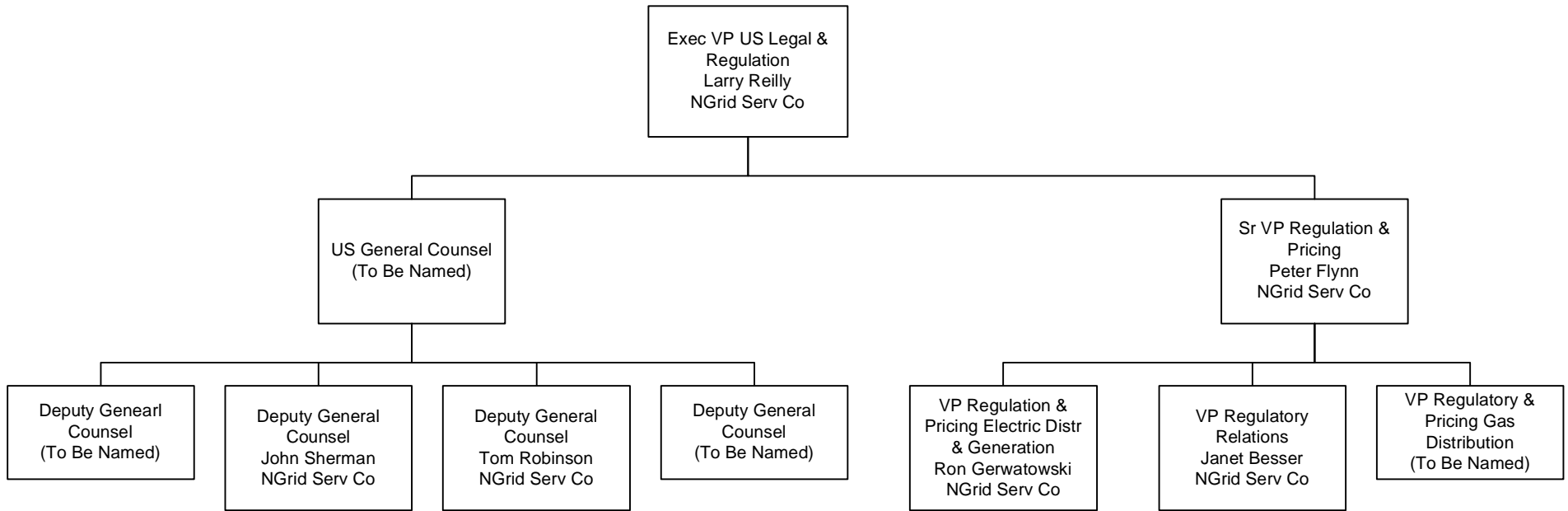

GECCO = Granite State Electric Company
 MECO = Massachusetts Electric Company
 Nant = Nantucket Electric Company
 NECO = The Narragansett Electric Company
 NECO Gas = Narragansett Electric Company
 NGrid Serv Co = National Grid USA Service Company Inc
 NIMO = Niagara Mohawk Power Corporation
 Information shown in Blue represents a Transmission Function
 Information shown in Red represents a Sales & Marketing Function

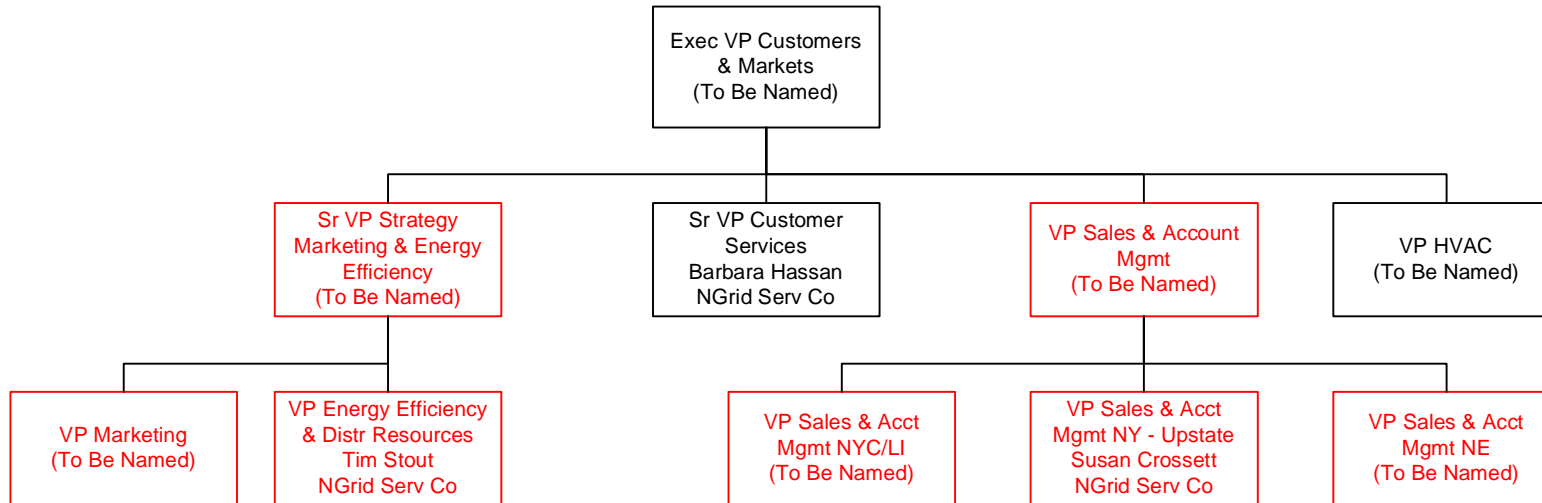

GECCO = Granite State Electric Company
 MECO = Massachusetts Electric Company
 Nant = Nantucket Electric Company
 NECO = The Narragansett Electric Company
 NECO Gas = Narragansett Electric Company
 NGrid Serv Co = National Grid USA Service Company Inc
 NIMO = Niagara Mohawk Power Corporation
 Information shown in Blue represents a Transmission Function
 Information shown in Red represents a Sales & Marketing Function

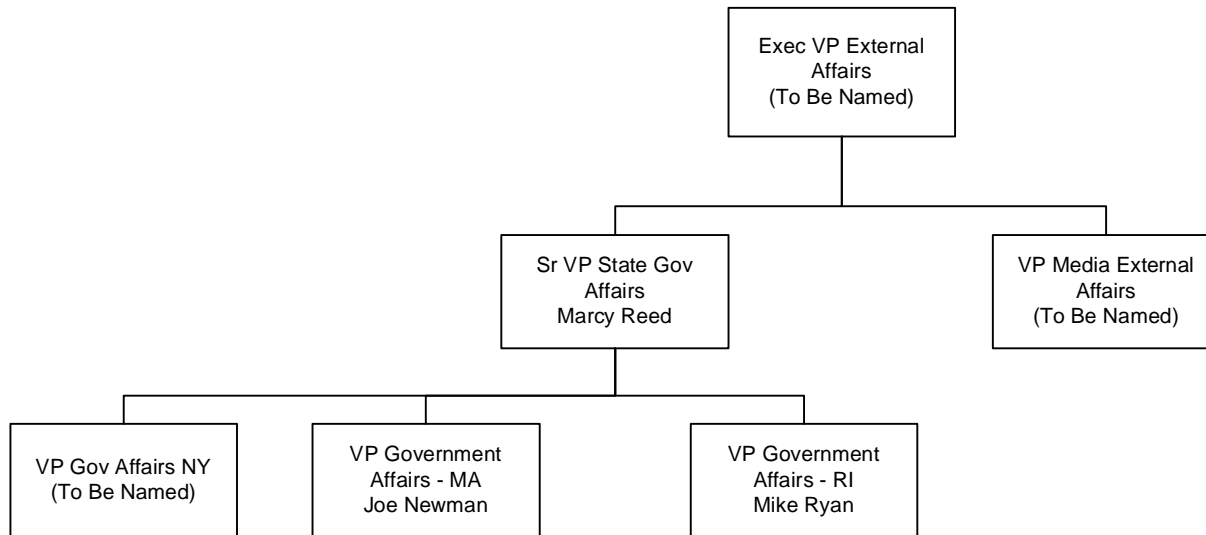

GECO = Granite State Electric Company
 MECO = Massachusetts Electric Company
 Nant = Nantucket Electric Company
 NECO = The Narragansett Electric Company
 NECO Gas = Narragansett Electric Company
 NGrid Serv Co = National Grid USA Service Company Inc
 NIMO = Niagara Mohawk Power Corporation
 Information shown in Blue represents a Transmission Function
 Information shown in Red represents a Sales & Marketing Function

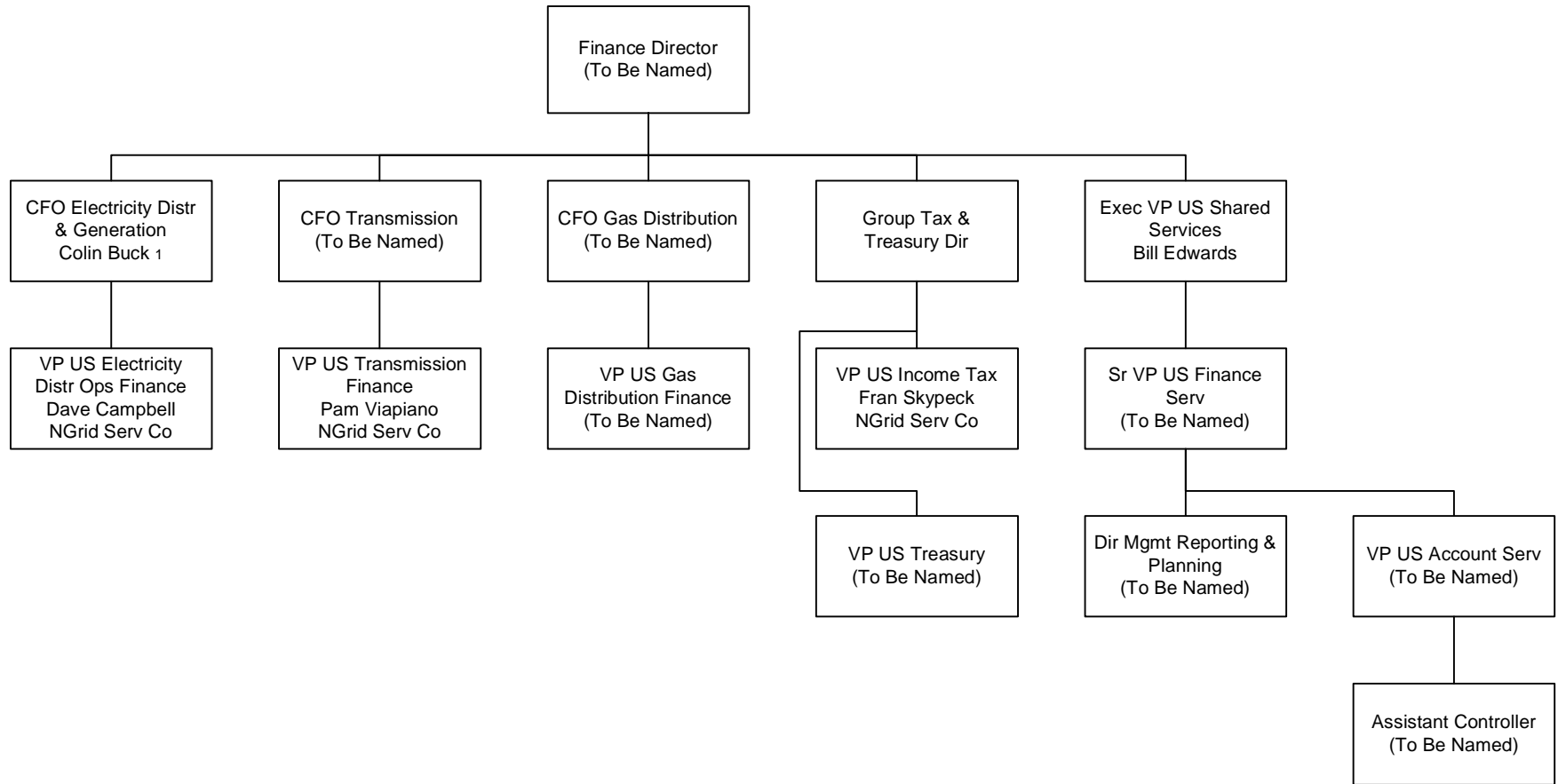

GECS = Granite State Electric Company
 MECO = Massachusetts Electric Company
 Nant = Nantucket Electric Company
 NECO = The Narragansett Electric Company
 NECO Gas = Narragansett Electric Company
 NGrid Serv Co = National Grid USA Service Company Inc
 NIMO = Niagara Mohawk Power Corporation
 Information shown in Blue represents a Transmission Function
 Information shown in Red represents a Sales & Marketing Function

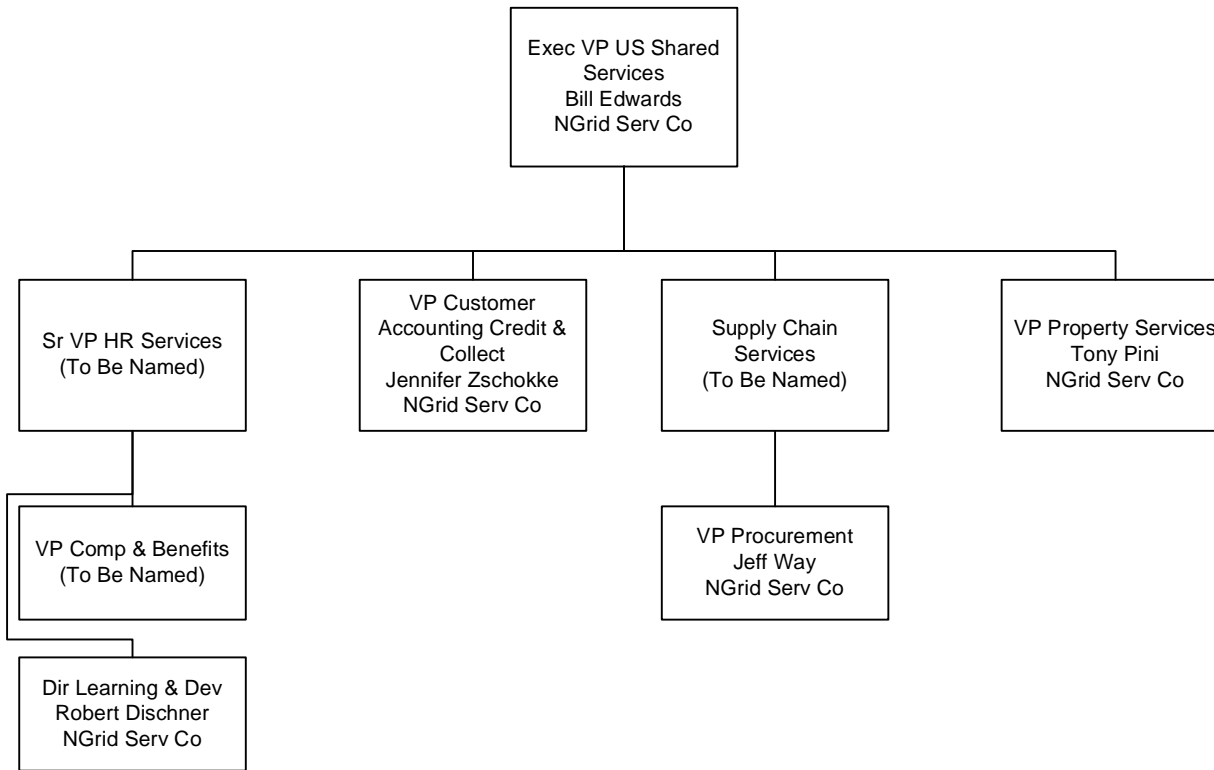

GECS = Granite State Electric Company
 MECO = Massachusetts Electric Company
 Nant = Nantucket Electric Company
 NECO = The Narragansett Electric Company
 NECO Gas = Narragansett Electric Company
 NGrid Serv Co = National Grid USA Service Company Inc
 NIMO = Niagara Mohawk Power Corporation
 Information shown in Blue represents a Transmission Function
 Information shown in Red represents a Sales & Marketing Function

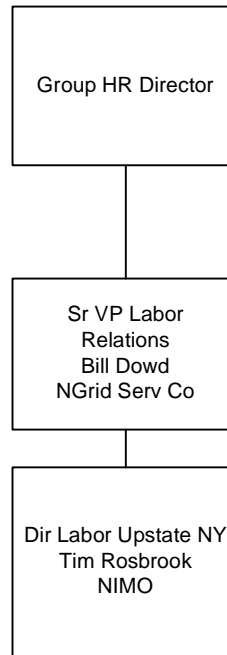

GECO = Granite State Electric Company
MECO = Massachusetts Electric Company
Nant = Nantucket Electric Company
NECO = The Narragansett Electric Company
NECO Gas = Narragansett Electric Company
NGrid Serv Co = National Grid USA Service Company Inc
NIMO = Niagara Mohawk Power Corporation
Information shown in Blue represents a Transmission Function
Information shown in Red represents a Sales & Marketing Function

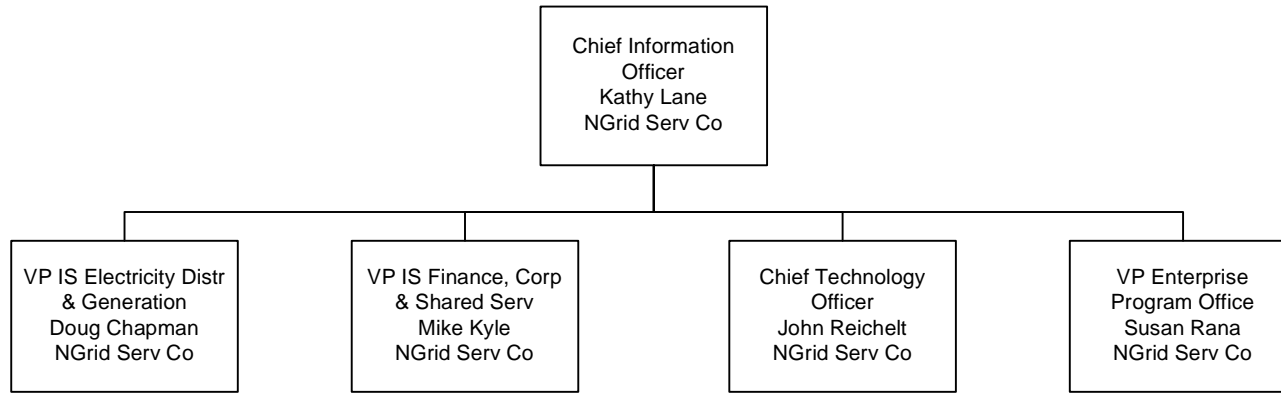

GECS = Granite State Electric Company
 MECO = Massachusetts Electric Company
 Nant = Nantucket Electric Company
 NECO = The Narragansett Electric Company
 NECO Gas = Narragansett Electric Company
 NGrid Serv Co = National Grid USA Service Company Inc
 NIMO = Niagara Mohawk Power Corporation
 Information shown in Blue represents a Transmission Function
 Information shown in Red represents a Sales & Marketing Function

**TRANSMISSION
(June 1, 2007)**

Senior VP & COO US Transmission, has primary responsibility for the overall planning, operations and control of the transmission system.

VP Construction and Services, responsible for construction of all capital projects as directed by the respective asset managers.

VP Transmission Regulation and Commercial, direct areas pertaining to regulation and industry policy for National Grid's US transmission business; coordinate with state government and state agencies pertaining to regulation and industry policy for National Grid's US transmission business

VP Operations, is responsible for the safe, reliable and effective operation of National Grid's Northeast Transmission System.

VP Transmission Asset Management, leads the development of policy, strategy and planning for transmission asset management and manages service provider–asset steward relationships for design, construction, maintenance and operations of transmission assets to optimize the long-term security and delivery capability of the transmission system that is cost-effective, safe and environmentally sound.

Projected Job Descriptions Post KeySpan Merger

NATIONAL GRID US - CORPORATE

(June 1, 2007)

Acting Exec Dir Elec Distr & Gen, (LaFleur) has primary responsibility for the profitability and growth of National Grid in the US. Directs the corporation in establishing long-range plans, strategy and policy with the Board of Directors.

Chief Information Officer, (Lane) responsibility for establishing and directing the strategic long term goals, policies and procedures for the company's information technology organization; the CIO determines the organization's long-term systems needs and hardware acquisitions to accomplish the organization's business objectives.

VP US Audit, (Partridge) Responsible for providing independent, objective assurance and consulting activity designed to add value and improve the organization's operations. Assist the organization to accomplish its objectives by bringing a systematic, disciplined approach to evaluate and improve the effectiveness of risk management, control and governance processes.

**Safety, Health, Environmental and Security
(June 1, 2007)**

SVP SHES, (Horan) Establish, maintain and enforce internal policy, to secure and ensure that the operations of the US lines of business are conducted in a manner to protect the health and safety of its employees and the public, protect and enhance the environment and manage and maintain a high level of security of the physical assets of the Company.

VP Safety, (Dienst) Develop and implement of safety management systems require the on-going maintenance of key management initiatives designed to resolve business issues and create business improvements

VP Environmental Services, (Kwasnik) responsible at National Grid USA for providing guidance to and oversight of the environmental compliance activities of the T&D operations and overall management of the Site Investigation and Remediation Program within National Grid USA.

GAS DISTRIBUTION
(June 1, 2007)

Sr VP Network Strategy, (Howe) Establish a single centralized Network Strategy function to drive consistency in developing, prioritizing and designing asset based work plans for the gas distribution business. Make optimal asset management decisions associated with all stages of asset lifecycle.

VP Ops & Construction NY Upstate, (Falise) Manage the Operational and Construction activities within a geographic boundary; managing resources to deliver a cost effective work operation while maintaining a safe, reliable gas supply network and associated services.

**ELECTRICITY DISTRIBUTION
(July 3, 2007)**

Executive VP Electric Distribution Ops (Pettigrew), responsible for the operations and asset management of electricity distribution assets in the US.

Senior VP Customer Operations (Root), responsible for unified field customers operations, including metering services; responsible for overall planning, operations and control of distribution systems; directs the maintenance, protection and improvement of all distribution equipment and facilities.

VP Asset Strategy & Investment Plan (Warren), responsible to analyze the root causes of asset performance and develop asset strategies into a strategic plan to improve reliability and reduce overall asset life cycle costs.

VP Distribution Engineering (Bouford), responsible for the efficient and effective engineering, design, analysis and other technical support provided to the operating companies of National Grid USA; this includes the diverse areas of substation, relay, transmission, meter and telecommunication engineering, design and standards; distribution standards and work-methods development; laboratory testing, qualification and operational support, asset management procedure and system analysis.

VP Project & Contract Mgmt (Proudman), responsible for the contracting of construction and maintenance work.

MERGERS AND ACQUISITIONS
(June 1, 2007)

Group Mergers and Acquisitions Director (Cochrane), Responsible for merger & acquisition long term strategy and activities on a globally basis.

VP US M&A Transactions, (McCormick) Responsible for merger & acquisition activities and special projects carried on in U.S.

LEGAL AND REGULATION
(June 1, 2007)

EVP US Legal & Regulation, (Reilly) serves as chief legal adviser, counsels management on legal implications of company activities and issues and provides legal services as required in judicial proceedings. Oversees corporation communications activities including the development of programs and policies for internal and external communications.

Deputy General Counsel, (Sherman) responsible for commercial **litigation**, environmental law, personal injury and property damage claims and compliance.

Deputy General Counsel, (Robinson) responsible for state **regulatory** affairs.

Sr VP Regulation and Pricing, (Flynn) Support all business lines in the US in the area of regulation and pricing. This includes developing a specific business line regulatory strategy which reflects current conditions but also anticipates emerging regulatory and public policy trends.

VP Regulation and Pricing Electric Distr and Generation, (Gerwatowski) Plan and implement a regulatory strategy with the appropriate business leaders that will enable the Electric Distribution and Generation Business to achieve the value targets in its business plan.

VP Regulatory Relations, (Besser) Act as the Company's key relationship officer with the Company's five regulatory commissions and their staff. Ensure effective communication with and across the US businesses and with the appropriate commissions.

CUSTOMERS AND MARKETS
(June 1, 2007)

VP Energy Efficiency & Distr Resources, (Stout) Provide leadership and management to the gas and electric energy efficiency, demand reduction and distributed resource initiatives to meet customer needs and improve the Company's cost structure and profitability.

SVP Customer Service, (Hassan) responsible for all center activities, credit and collections, billing, revenue protection, metering services and customer satisfaction.

VP Sales and Accounting Management NY, (Crosset) Responsible for the leadership and management of all residential Sales

EXTERNAL AFFAIRS
(June 1, 2007)

Sr VP State Government Affairs, (Reed) Plans and directs all aspects of an organization's policies and objectives involving matters of state government and regulations.

VP Government Affairs - MA, (Newman) Responsible for tracking, monitoring, and influencing government actions that impact Company's business plan in the state of Massachusetts. Provides Senior Management with strategic advice on governmental, political or communications issues and act as lead Lobbyist for all policy issues before State government. Serve as liaison to Congressional District offices to resolve constituent and community issues.

VP Government Affairs - RI, (Ryan) Responsible for tracking, monitoring, and influencing government actions that impact Company's business plan in the state of Rhode Island. Provides Senior Management with strategic advice on governmental, political or communications issues and act as lead Lobbyist for all policy issues before State government. Serve as liaison to Congressional District offices to resolve constituent and community issues.

INTEGRATED FINANCE
(June 1, 2007)

VP US Electricity Distr Ops Finance, (Campbell) Overall responsibility for directing all aspects of financial support within the Electricity Distribution Business Unit and the Customer & Marketing unit. This includes sales and revenue analysis, business unit accounting support and analysis, budget development and analysis (O&M and capital), cost control, decision support, benchmarking, operational metrics, and financial analysis.

VP Transmission Finance, (Viapiano) is responsible for financial analysis, internal reporting, budgeting and forecasting, contract and tariff billing, rates and business planning activities for National Grid USA's transmission operations in New England and New York Also responsible for financial analysis, internal reporting, budgeting for the US Interconnector (HVDC link with Canada)

VP US Income Tax, (Skypeck) Responsible for compliance with all US income tax requirements, including timely and accurate compliance with tax regulations; calculation and payment of taxes due; management of the relationship with the IRS and various tax advisors and accounting for tax under both IFRS and US GAAP.

EVP US Shared Services, (Edwards) Directs and plans the administration of Human Resources Services; Financial Services; Supply Chain Services and Property Services.

SHARED SERVICES
(June 1, 2007)

Dir Learning & Dev, (Dischner) responsible for the development and implementation of effective training programs for electric, gas and meter operations – both technical and non-technical where appropriate. Responsible for providing leadership for short and long term technical employee development strategies.

VP Customer Accounting Credit and Collections, (Zschokke) supports the US operations by planning, establishing, directing, coordinating and executing Customer Accounting, Credit & Collections policies and strategies with direct functional responsibility for Billing and Systems; Credit and Collections; Revenue Accounting and Payment Processing; Meter Data Services.

VP Procurement, (Way) Responsible for leading US Procurement services through planning, directing and executing strategies that enable the cost effective procurement of raw materials, supplies, equipment and services to achieve company goals and objectives.

VP Property Services, (Pini) Responsible for supporting the US operations by planning, establishing, directing, coordinating and executing Property Services policies and strategies with direct functional responsibility for leading Facilities Management, Real Estate Services and Office Services, including Records Management, Mail Services and Print Shop Services.

HUMAN RESOURCES
(June 1, 2007)

Sr VP Labor Relations, (Dowd) Sets internal policy and provides oversight for the administration of labor agreements, negotiations, grievances, arbitration, and all associated labor responsibilities.

Director Labor NY, (Rosbrook) supervises activities related to the negotiation, interpretation and administration of collective bargaining agreements. Administers dispute resolution procedures and certain HR policies and procedures associated with union employees.

INFORMATION SERVICES
(June 1, 2007)

Chief Information Officer, (Lane) responsibility for establishing and directing the strategic long term goals, policies and procedures for the company's information technology organization; the CIO determines the organization's long-term systems needs and hardware acquisitions to accomplish the organization's business objectives.

VP IS Electricity Distr & Generation, (Chapman) Provides leadership and management to I/S organization supporting the global Electricity Distribution & Generation. Includes oversight of application design, maintenance and support services.

VP IS Finance, Corp & Shared Serv, (Kyle) Provides leadership and management to I/S organization supporting the Finance, Corporate and Shared Services functions. Includes oversight of application design, maintenance and support services.

Chief Technology Officer, responsible for setting the strategic computing and communications technology strategy for the Group.

VP Enterprise Program Office, (Rana) responsible for managing the Program Office for the global IS function - setting and maintaining project management methods, providing project governance expertise, coordinating timely resource allocation for all projects; this role will also manage small but globally focused IS communications, IS strategy, Acquisition COE and IS Quality teams.