

Index of Charts and Descriptions

Corporate Organization Chart	Updated: 09/17/04
Shared Services	Updated: 09/17/04
Transmission	
• Organization Chart	Updated: 10/19/04
• Job Descriptions	Updated: 09/17/04
Transmission Finance	
• Organization Chart	Updated: 09/17/04
• Job Descriptions	Updated: 09/17/04
Transmission Network Planning and Operations	
• Organization Chart	Updated: 09/17/04
• Job Descriptions	Updated: 09/17/04
Transmission Network Operations	
• Organization Chart	Updated: 09/17/04
• Job Descriptions	Updated: 09/17/04
National Grid USA	
• Organization Chart	Updated: 09/17/04
• Job Descriptions	Updated: 09/17/04
Chief Operating Officer	
• Organization Chart	Updated: 09/17/04
• Job Descriptions	Updated: 09/17/04
New England Distribution	
• Organization Chart	Updated: 09/17/04
• Job Descriptions	Updated: 09/17/04
Business and Retail Services New England	
• Organization Chart	Updated: 10/19/04
• Job Descriptions	Updated: 10/19/04
Business Services and Public Affairs Narragansett Electric	
• Organization Chart	Updated: 09/17/04
• Job Descriptions	Updated: 09/17/04
Business Services and Public Affairs Granite State	
• Organization Chart	Updated: 10/19/04
• Job Descriptions	Updated: 10/19/04
New England Distribution Operations	
• Organization Chart	Updated: 09/17/04
• Job Descriptions	Updated: 09/17/04
New England and New York Construction and Maintenance Services	
• Organization Chart	Updated: 10/12/04
• Job Descriptions	Updated: 10/05/04

New England Distribution Dispatch and Control

- Organization Chart
- Job Descriptions

Updated: 09/17/04
Updated: 09/17/04

New England Distribution Electric Distribution Planning and Engineering

- Organization Chart
- Job Descriptions

Updated: 09/17/04
Updated: 09/17/04

Customer Service

- Organization Chart
- Job Descriptions

Updated: 09/17/04
Updated: 09/17/04

New England Distribution Finance

- Organization Chart
- Job Descriptions

Updated: 09/17/04
Updated: 09/17/04

New York Distribution

- Organization Chart
- Job Descriptions

Updated: 09/17/04
Updated: 09/24/04

Business Services and Economic Development

- Organization Chart
- Job Descriptions

Updated: 09/17/04
Updated: 09/17/04

New York Distribution Dispatch and Control

- Organization Chart
- Job Descriptions

Updated:11/02/04
Updated:10/08/04

New York Distribution Electric Distribution Planning and Engineering

- Organization Chart
- Job Descriptions

Updated: 10/12/04
Updated: 10/19/04

New York Customer Service

- Organization Chart
- Job Descriptions

Updated: 09/17/04
Updated: 09/17/04

Customer Satisfaction and Strategic Planning and Support

- Organization Chart
- Job Descriptions

Updated: 09/17/04
Updated: 09/17/04

New York Distribution Finance

- Organization Chart
- Job Descriptions

Updated: 09/17/04
Updated: 09/27/04

Information Technology

- Organization Chart
- Job Descriptions

Updated: 09/17/04
Updated: 09/17/04

Information Technology Infrastructure

- Organization Chart
- Job Descriptions

Updated: 09/17/04
Updated: 09/17/04

Information Technology Application Development

- Organization Chart
- Job Descriptions

Updated: 09/17/04
Updated: 09/17/04

T&D Technical Services

- Organization Chart
- Job Descriptions

Updated: 09/17/04
Updated: 09/17/04

T&D Technical Services Engineering Services

- Organization Chart
- Job Descriptions

Updated:10/12/04
Updated:11/09/04

T&D Technical Services Technical Training

- Organization Chart
- Job Descriptions

Updated: 09/17/04
Updated: 09/17/04

T&D Technical Services Environmental

- Organization Chart
- Job Descriptions

Updated: 09/17/04
Updated: 09/17/04

T&D Technical Services Process and Systems

- Organization Chart
- Job Descriptions

Updated: 09/17/04
Updated: 09/17/04

T&D Technical Services Fleet Management

- Organization Chart
- Job Descriptions

Updated: 09/17/04
Updated: 09/17/04

T&D Technical Services Supply Chain Management

- Organization Chart
- Job Descriptions

Updated: 09/17/04
Updated: 09/17/04

Property and Real Estate Management Facilities

- Organization Chart
- Job Descriptions

Updated: 09/17/04
Updated: 09/17/04

Business Development

- Organization Chart
- Job Descriptions

Updated: 09/17/04
Updated: 09/17/04

Finance

- Organization Chart
- Job Descriptions

Updated: 09/17/04
Updated: 09/17/04

Finance Vice President and Controller

- Organization Chart
- Job Descriptions

Updated: 09/17/04
Updated: 09/17/04

Real Estate Management and Property Tax

- Organization Chart
- Job Descriptions

Updated: 09/17/04
Updated: 09/17/04

Human Resources

- Organization Chart
- Job Descriptions

Updated: 10/25/04
Updated: 09/17/04

Legal and External Relations

- Organization Chart
- Job Descriptions

Updated:10/25/04
Updated:10/05/04

GridAmerica

- Organization Chart
- Job Descriptions

Updated:10/05/04
Updated:11/09/04

Color Key:

Granite State Electric:	Light Blue
Nantucket Electric:	Lime Green
Narragansett Electric:	Purple
Niagara Mohawk:	Pink
Massachusetts Electric:	Green
Sales and Marketing Related:	Red
National Grid Service Co:	Black
Transmission Related:	Blue

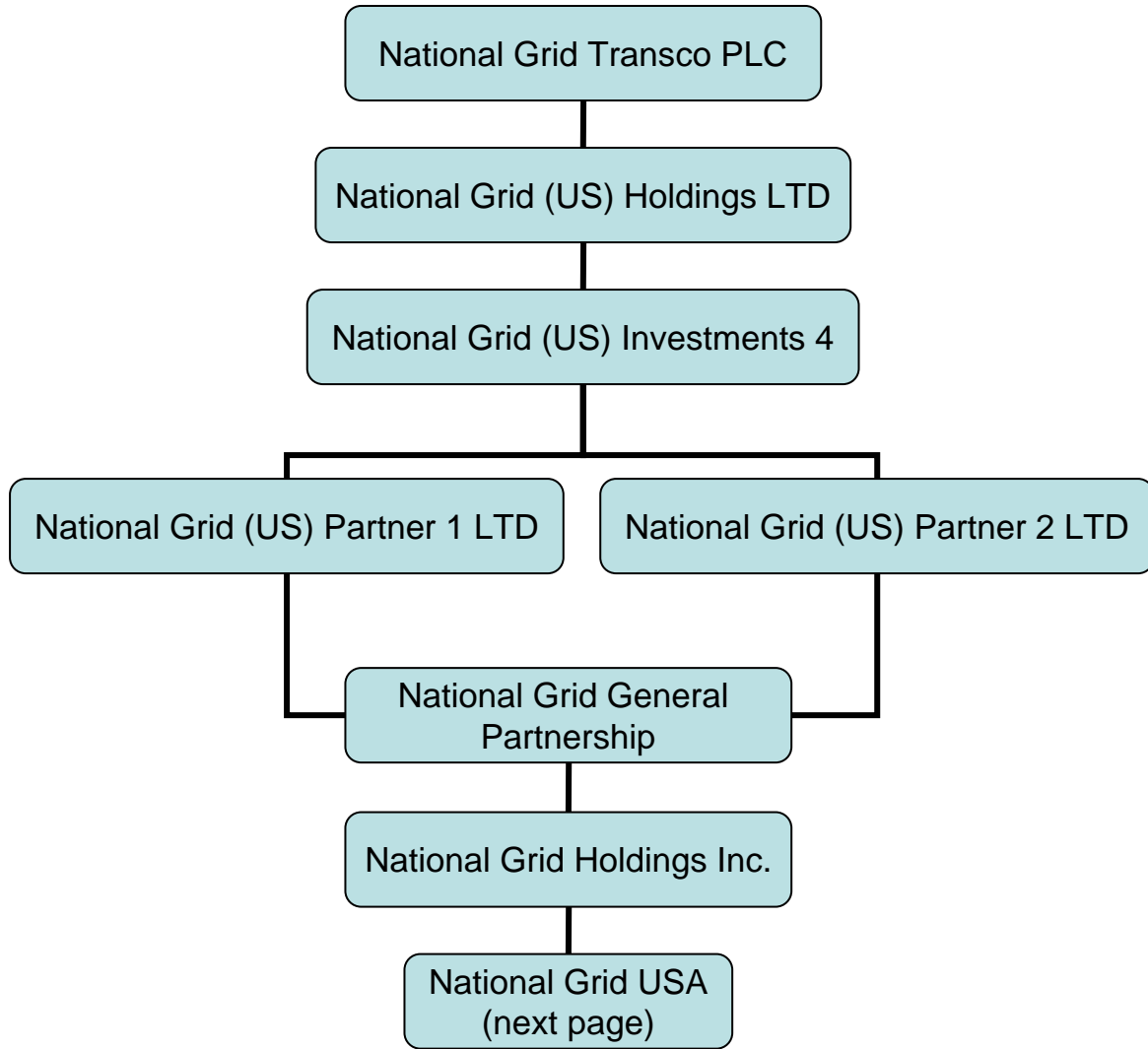

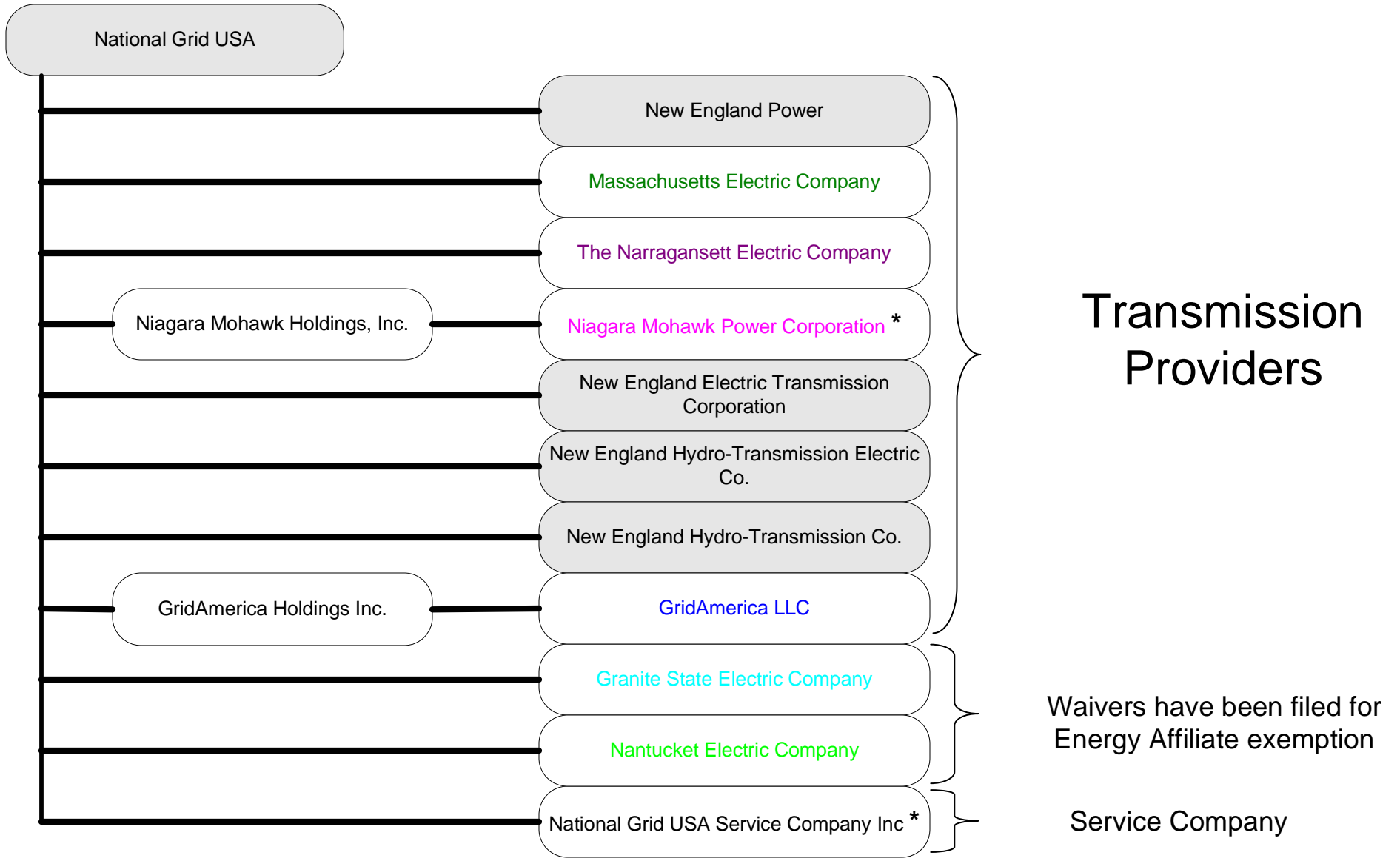

* Includes transmission function employees, employees engaged in Marketing, Sales or Energy Affiliate activities, and shared support units. The shared support units are identified and described in the document posted under Shared Services.

Shared Services

Human Resources

Human Resources Services – consults and collaborates with management to develop and implement HR strategies in the areas of workforce planning, employment, organizational design, organizational development and performance management.

Labor Relations – responsible for negotiation, interpretation and administration of collective bargaining agreements.

Employee Services – responsible for employee transactions, employee call center, policy interpretation, maintenance of personnel records, complaint investigations and compliance with applicable laws and rules affecting employees.

Payroll – responsible for all aspects of payroll processing.

HR IS – responsible for human resources data needs.

Health & Welfare Plan – responsible for the design, implementation and management of welfare benefit plans.

Compensation – designs, plans, implements and administers corporate compensation programs, policies and procedures including incentive plans.

Legal & External Relations

Corporate Security – management of all aspects of security, including contract security, threat management, and liaison with state and federal law enforcement.

Corporate Communications – management of media relations, employee communications, customer communications, corporate advertising and marketing, and community relations.

Transmission and Federal Affairs – responsible for federal regulatory affairs and legal support for the Transmission organization.

Commercial – responsible for corporate and commercial legal matters.

Regulatory – responsible for state regulatory affairs.

Property – responsible for property and real estate matters and transactions.

Litigation - responsible for commercial litigation, environmental law, personal injury and property damage claims and compliance.

Ethics & Compliance – responsible for governance and compliance related programs and initiatives, including standards of conduct, ethics, risk and compliance management, and environmental and safety compliance audit.

Internal Audit – is responsible for providing Management and the Audit Committee and the Board of National Grid Transco with an independent assessment of the adequacy and effectiveness of the Company's management systems and related controls.

Information Technology

Infrastructure – responsible for the design, deployment, and operations of the computing and communications infrastructure, as well as the Energy Management Systems used to operate the electric system within the National Grid service territory.

Applications Development – responsible for the development, configuration, and support of business software applications.

Strategy & Planning – provides support and planning services related to enterprise architecture, cyber security, cost accounting and budgeting, contract and asset management and disaster recovery.

Treasury

Treasury Services – provides corporate finance and banking services to all entities within the National Grid USA group of companies.

Investment Management – is responsible for overseeing the investments in the employee benefit trusts.

Claims – investigates, evaluates and disposes of third party claims.

Accounting

Revenue Accounting – responsible for revenue reporting, account receivable and miscellaneous billing.

Financial Reporting – responsible for creating, summarizing, and reporting financial statements and disclosures to the parent company and third parties.

System Support – ensures the effective operation and use of the ERP systems by working with business owners, Information Technology, and ERP Support.

Accounting Services – responsible for maintaining the financial books and records of the National Grid USA group of companies.

Corporate Tax – responsible for tax return compliance, managing federal and state audits, tax research and planning, and accounting for income taxes.

Real Estate Management & Property Tax – responsible for managing property tax and acquiring and disposing of real estate rights.

Forecasting, Budgeting and Planning – is responsible for the consolidation and reporting of all National Grid USA financial forecasts, budgets and business plans to NGT Corporate Finance.

T&D Technical Services

Engineering Services

Substation Engineering – operational and design support for substations

Delivery Engineering – operational and design support for power lines

Protection & Meter Engineering – operational and design support for power system controls and metering

Lab and Testing Services – meter and rubber goods testing and services, field and laboratory services, and instrument service and repair.

T&D Systems Engineering – system performance and asset strategy analysis, benchmarking and R&D.

Technical Training – technical training for electric and gas businesses

Environmental – environmental compliance support services

Meter & Data Services – acquire, process, analyze and distribute energy information for use in market settlement and customer billing

Process & Systems – development, implementation, and ongoing user support of operations applications

Fleet Management – asset management including service and repair of corporate transportation fleet.

Supply Chain – procurement, accounts payable, and inventory management services.

Facilities Asset Management – operation and maintenance of employee occupied facilities

Health and Safety Services – provides regulatory required records and reporting of occupational injuries, safety committee and management professional support, safety observation tours, medical surveillance and DOT required reporting, Employee Assistance Program, and regulatory guidance, interpretation, and accompanying policies and procedures.

Transmission

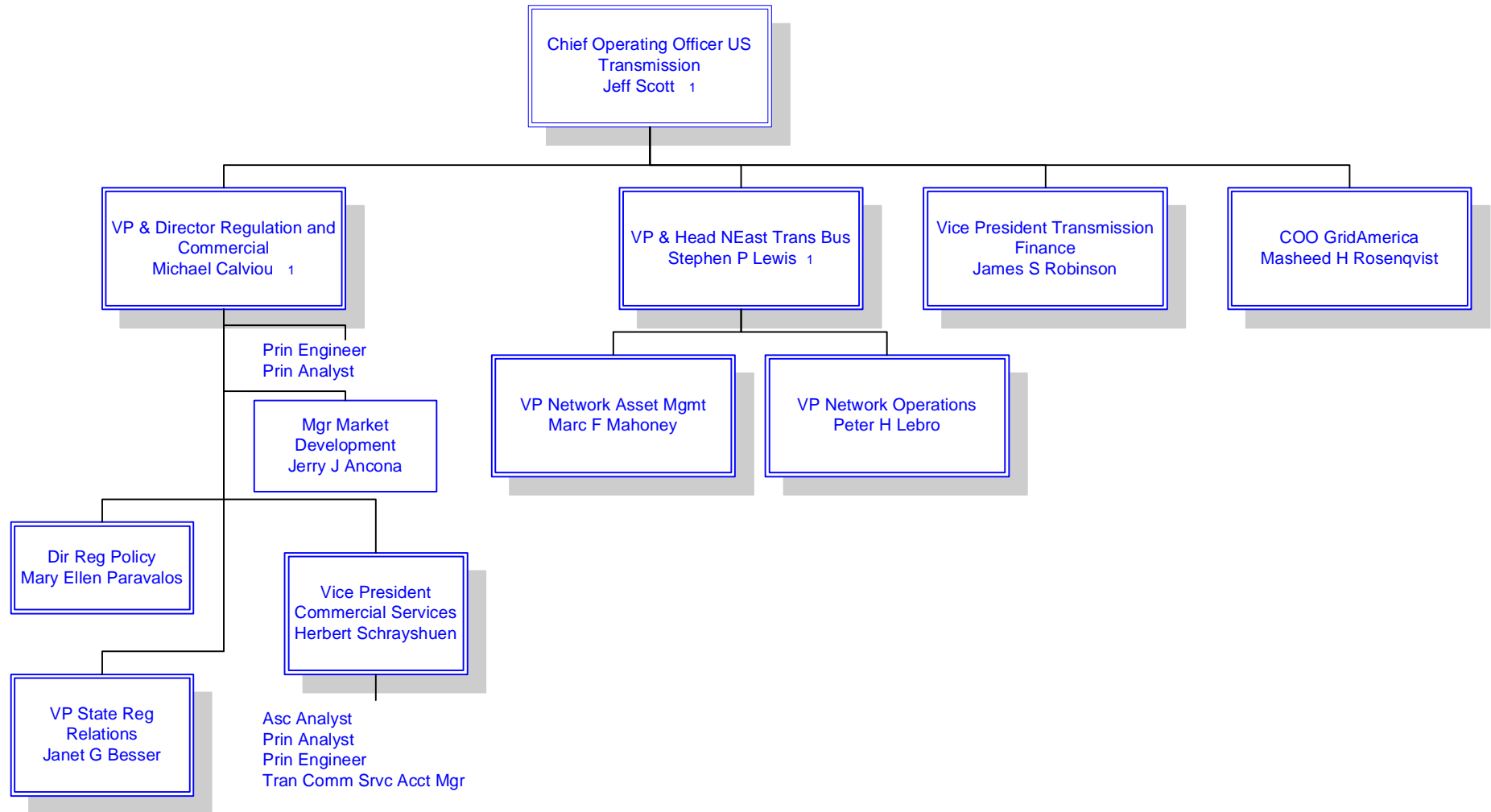

1 On assignment from the UK

NOTE: The positions and individuals depicted in blue on this page are National Grid USA Service Co employees

Last Updated 10/19/04

Job Descriptions

Transmission Finance

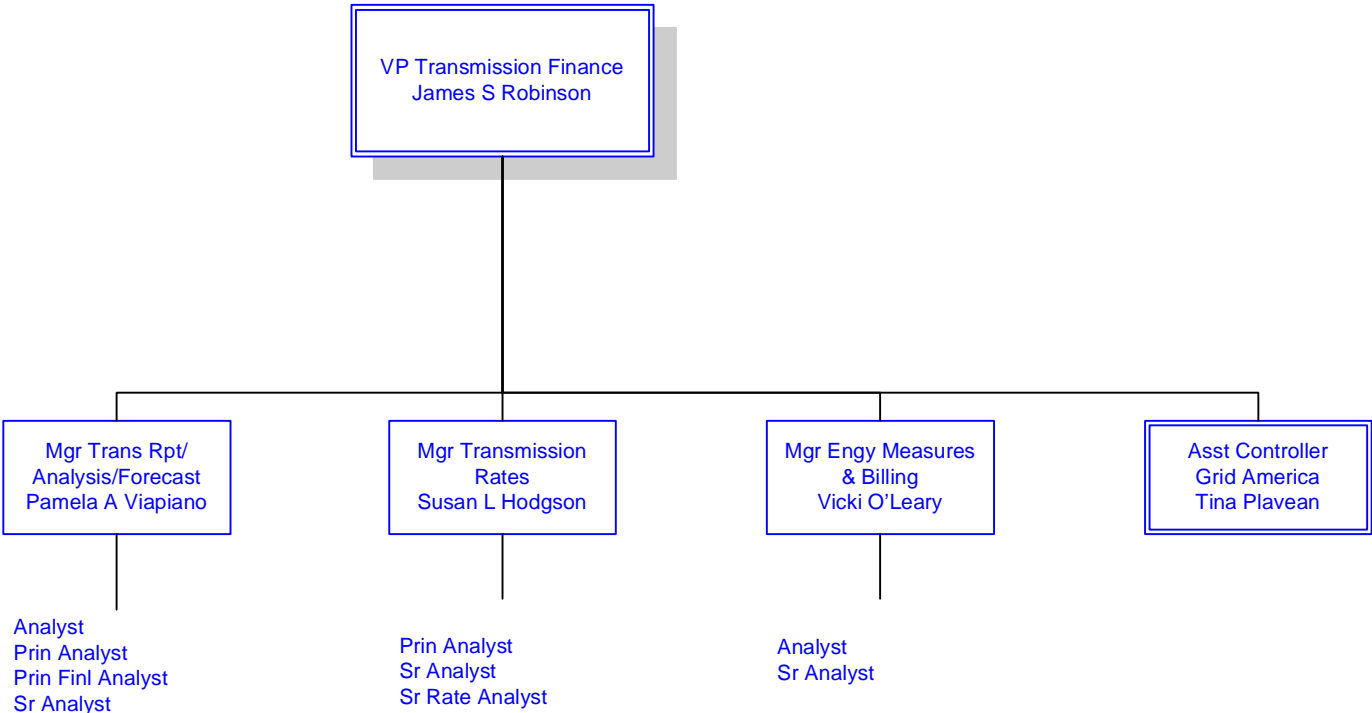

NOTE: The positions and individuals depicted in blue on this page are National Grid USA Service Co employees

Transmission Network Planning and Operations

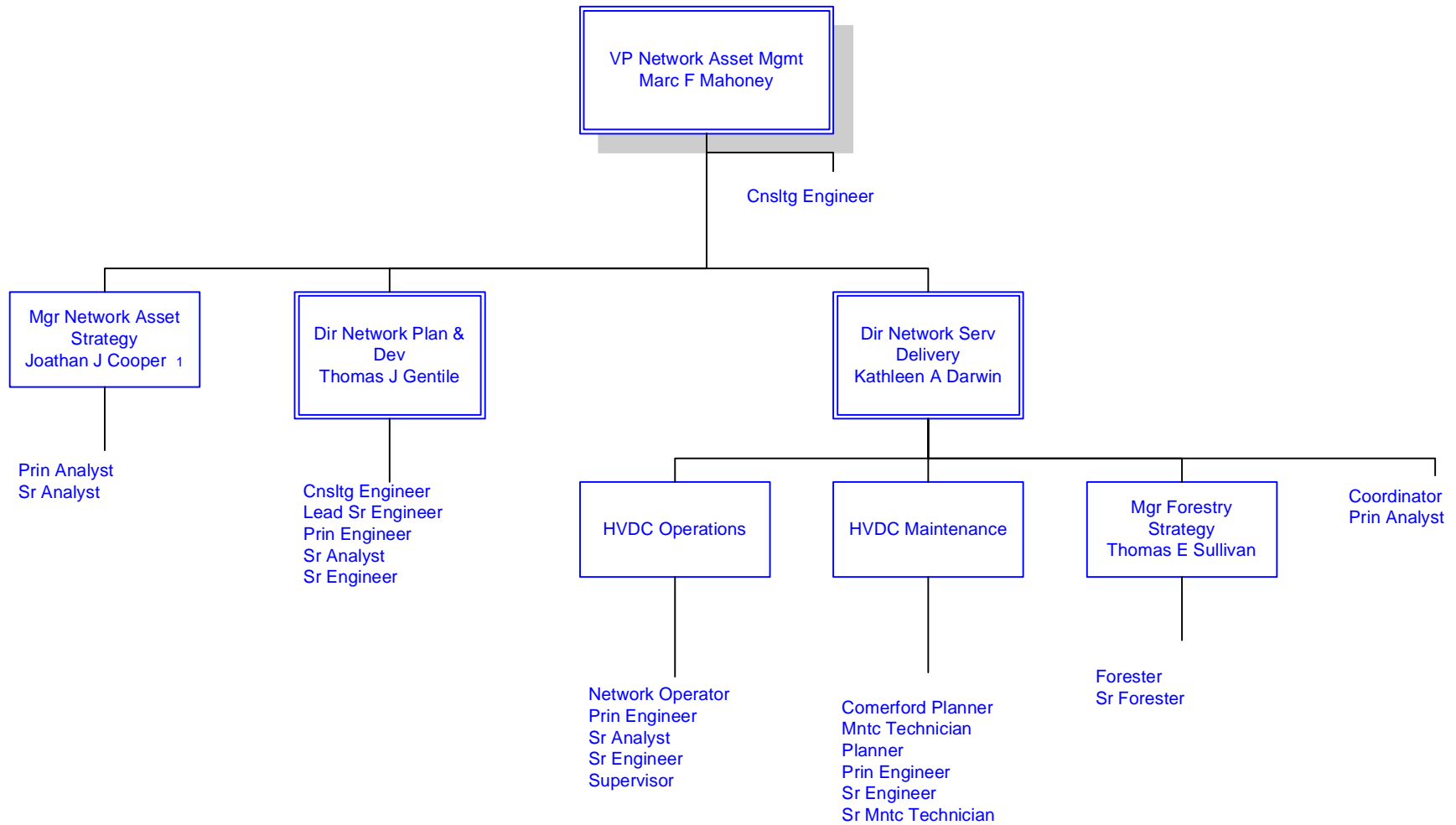

1 On assignment from the UK

NOTE: The positions and individuals depicted in blue on this page are National Grid USA Service Co employees

Last Updated 09/17/04

Job Descriptions

Transmission Network Operations

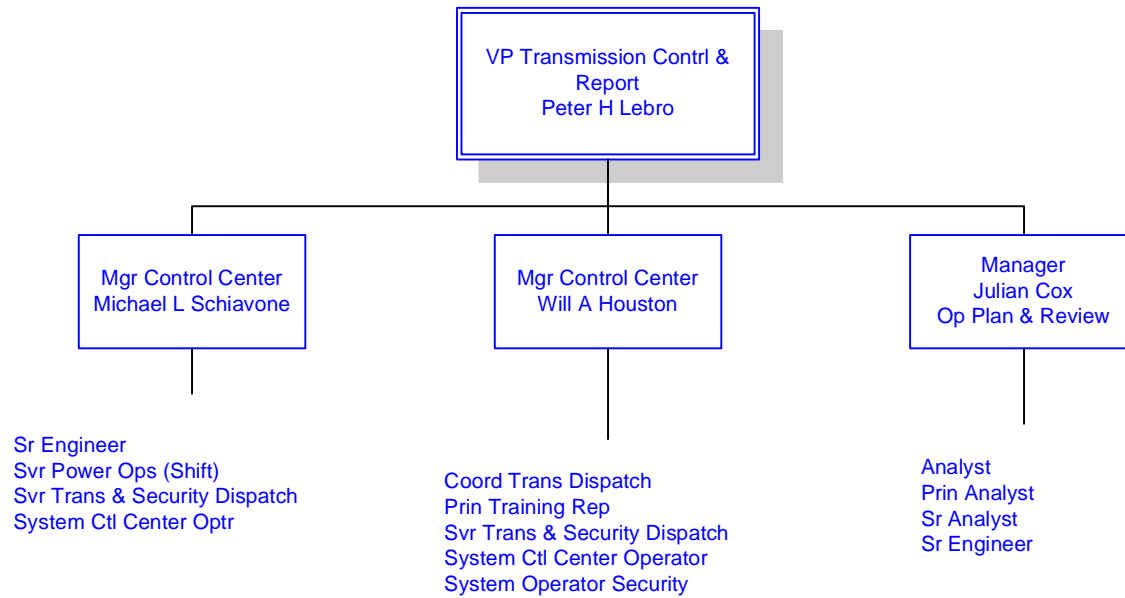

NOTE: The positions and individuals depicted in blue on this page are National Grid USA Service Co employees

Last Updated 09/17/04

Job Descriptions

National Grid USA

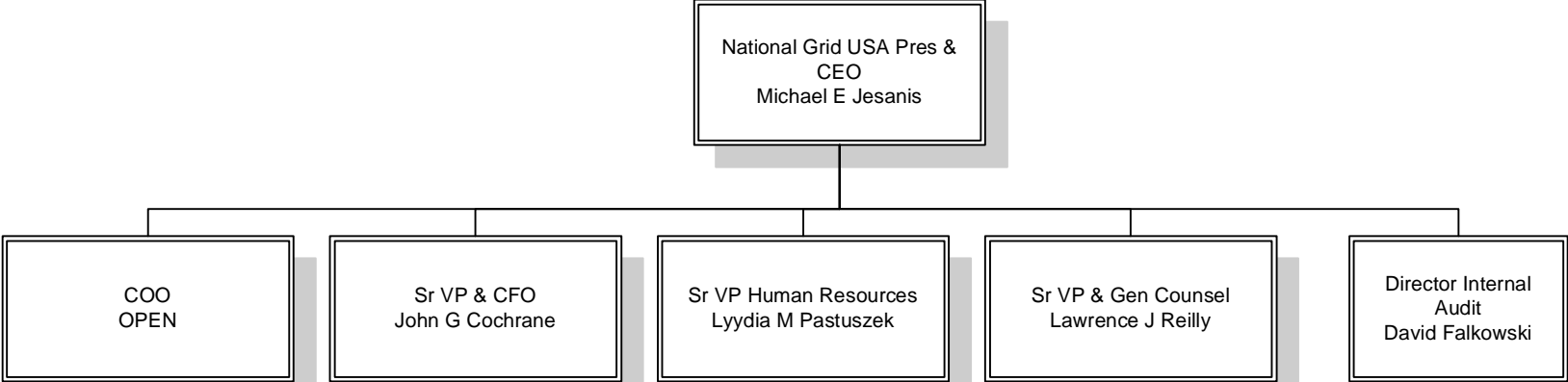

Chief Operating Officer

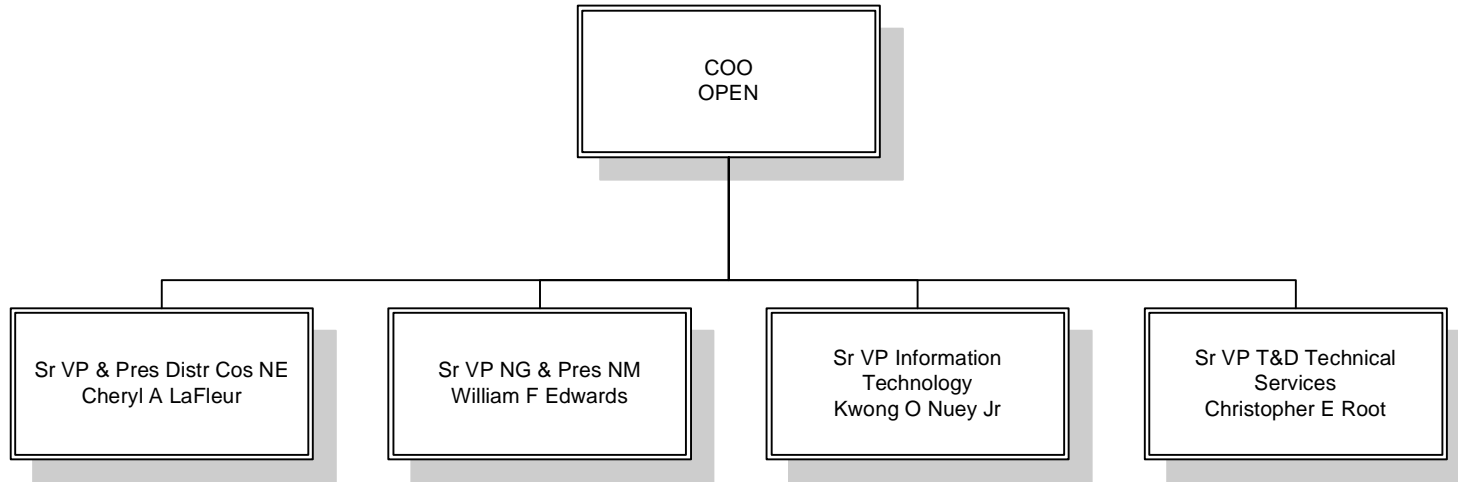

New England Distribution

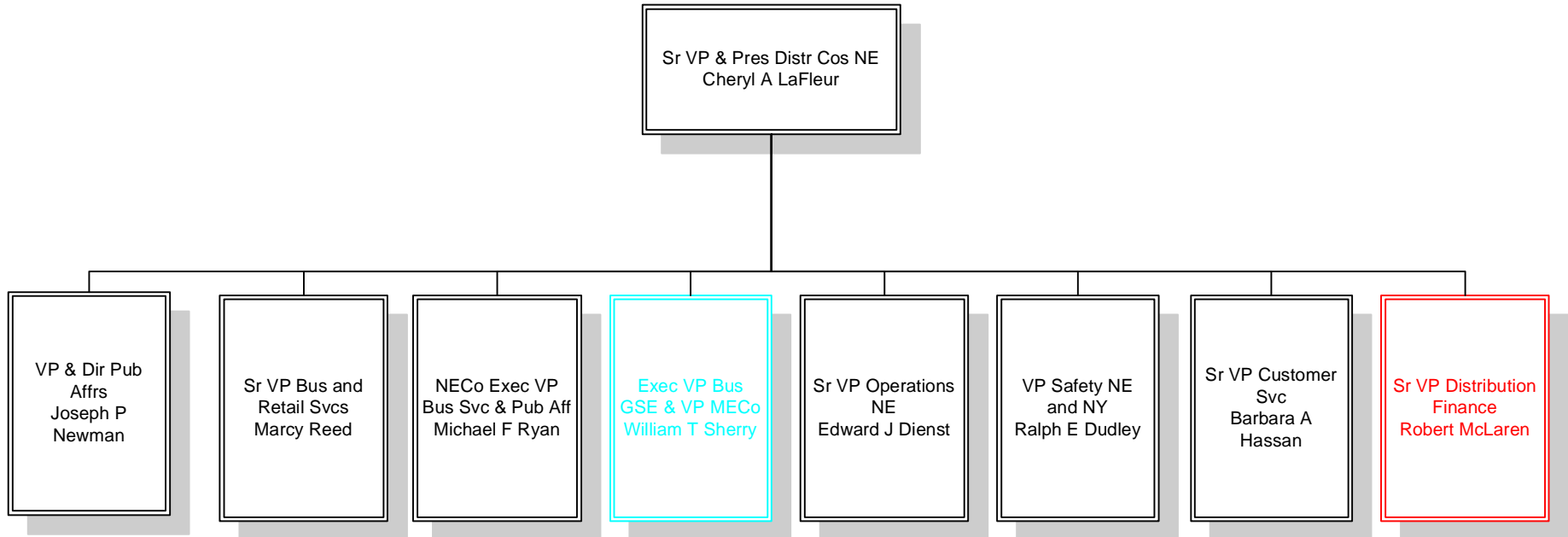

NOTE: The positions and individuals depicted in red on this page are National Grid USA Service Co employees

Last Updated 09/17/04

Job Descriptions

Business and Retail Services New England

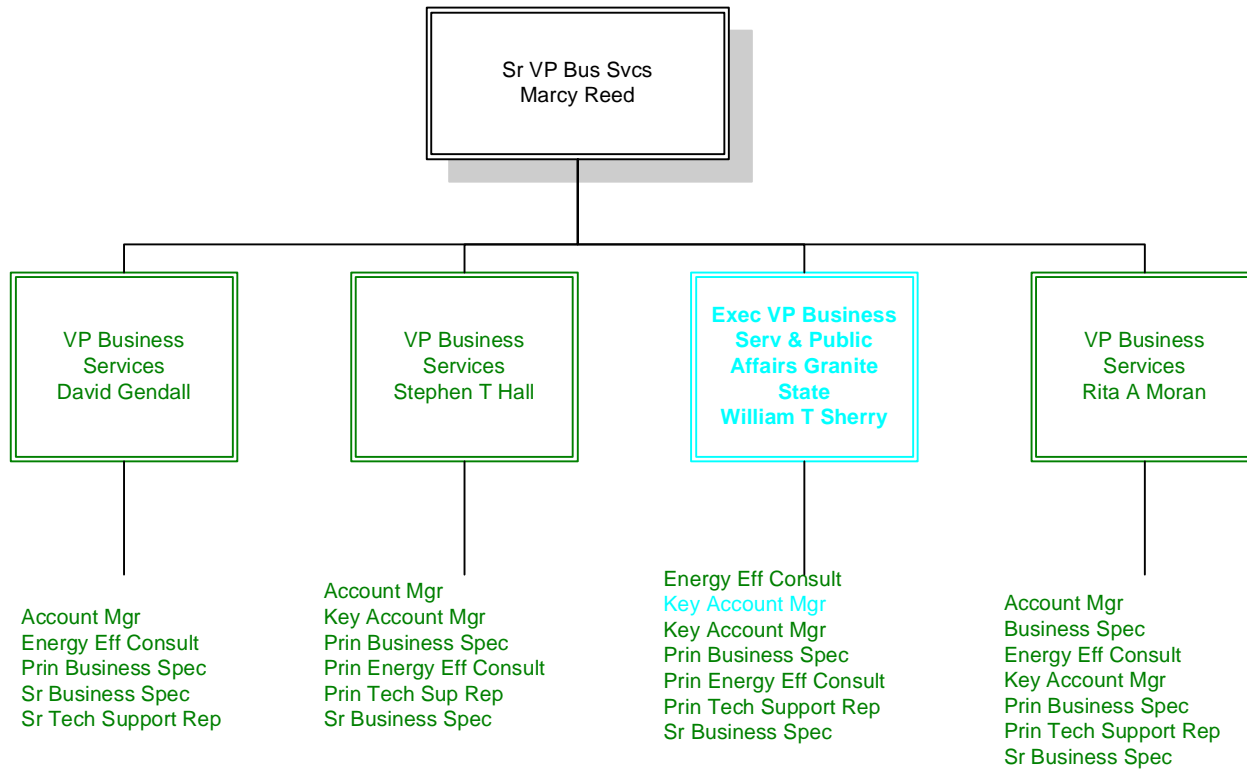

Business Services and Public Affairs Narragansett Electric

NECo Exec VP Bus Svc &
Pub Aff
Michael F Ryan

VP Business
Services
Frederick L Mason

Account Mgr
Account Rep
Sr Account Rep
Sr Tech Support Rep

Business Services and Public Affairs Granite State

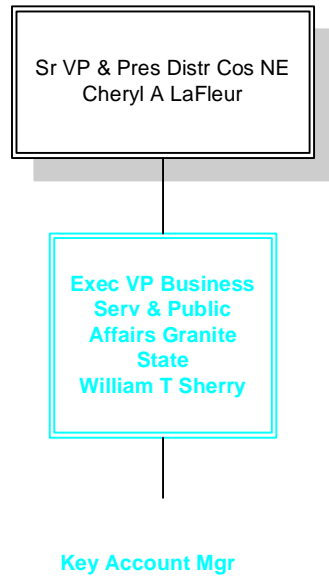

New England Distribution Operations

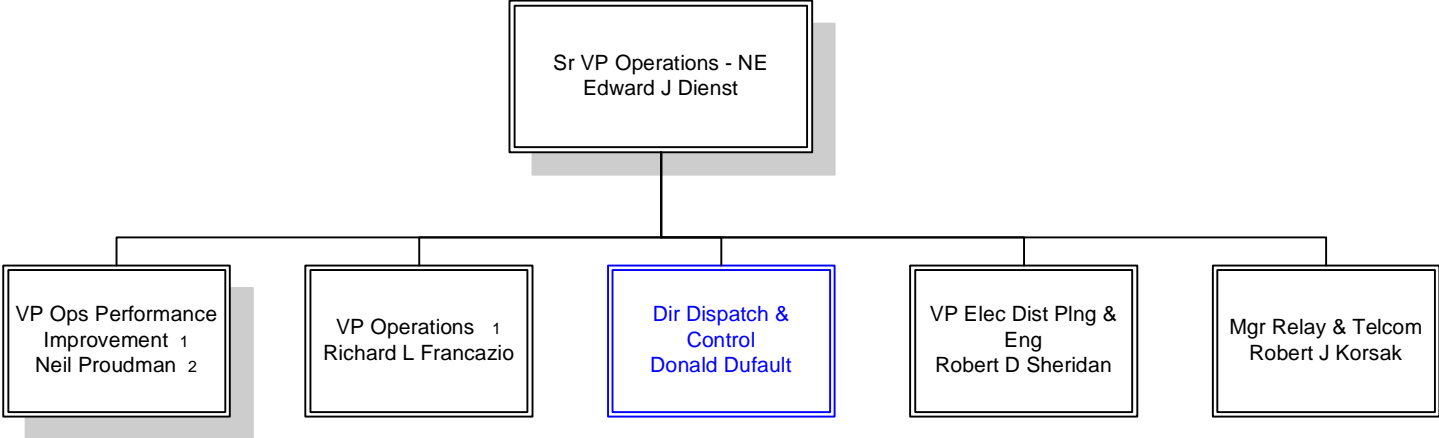

1 This function reports to the Senior Vice President Operations for both New England and New York

2 This individual is on assignment from the UK

NOTE: The positions and individuals depicted in blue on this page are National Grid USA Service Co employees

New England and New York Construction and Maintenance Services

VP Operations
Richard L. Francazio

Operations Planner

Dir Contract Mgmt
Timothy Horan

Dir Substation
Construction
Arthur Curran

Dir Transmission
Line Services
Joseph Luchini

Mgr Distrb Forestry
Craig Allen

Prin Analyst

Sr Analyst
Supervisor

Superintendent
Natale Edward

Arborist
Sr Arborist
System Arborist

Coor O/H Lines
Scheduler

Mgr Quality/Field
Contracts
Michael
Szczepanek

Dist Contract
Serv
Manager
Gerald P
Convery

Mgr Field
Accounting
Diane Benedetto

Mgr Planning &
Scheduling
William J
Hofmann

Mgr Quality/Gas
Contracts
Byran R Buck

Asc Analyst
Construction Coor
Contracts Coordinator
Coor T&D Ctl Systems
Lead Sr Engineer
Supervisor

Coordinator
Sr Engineer Fld

Supervisor

Analyst
Prin Analyst

Construction Coor

NOTE: The positions and individuals depicted in blue on this page are National Grid USA Service Co employees

Last Updated 10/05/04

Job Descriptions

New England Distribution Dispatch and Control

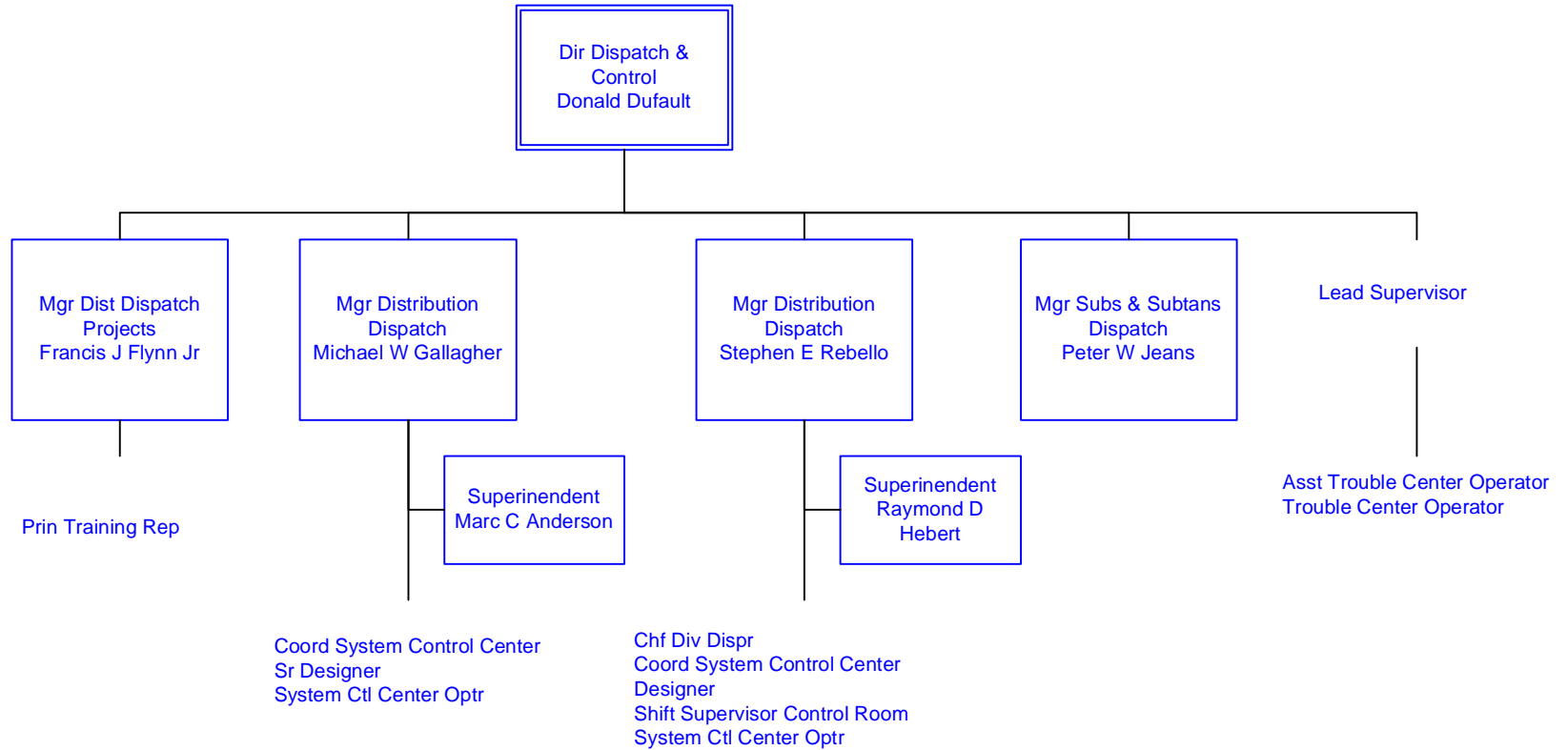

NOTE: The positions and individuals depicted in blue on this page are National Grid USA Service Co employees

Last Updated 09/17/04

Job Descriptions

New England Distribution Electric Distribution Planning and Engineering

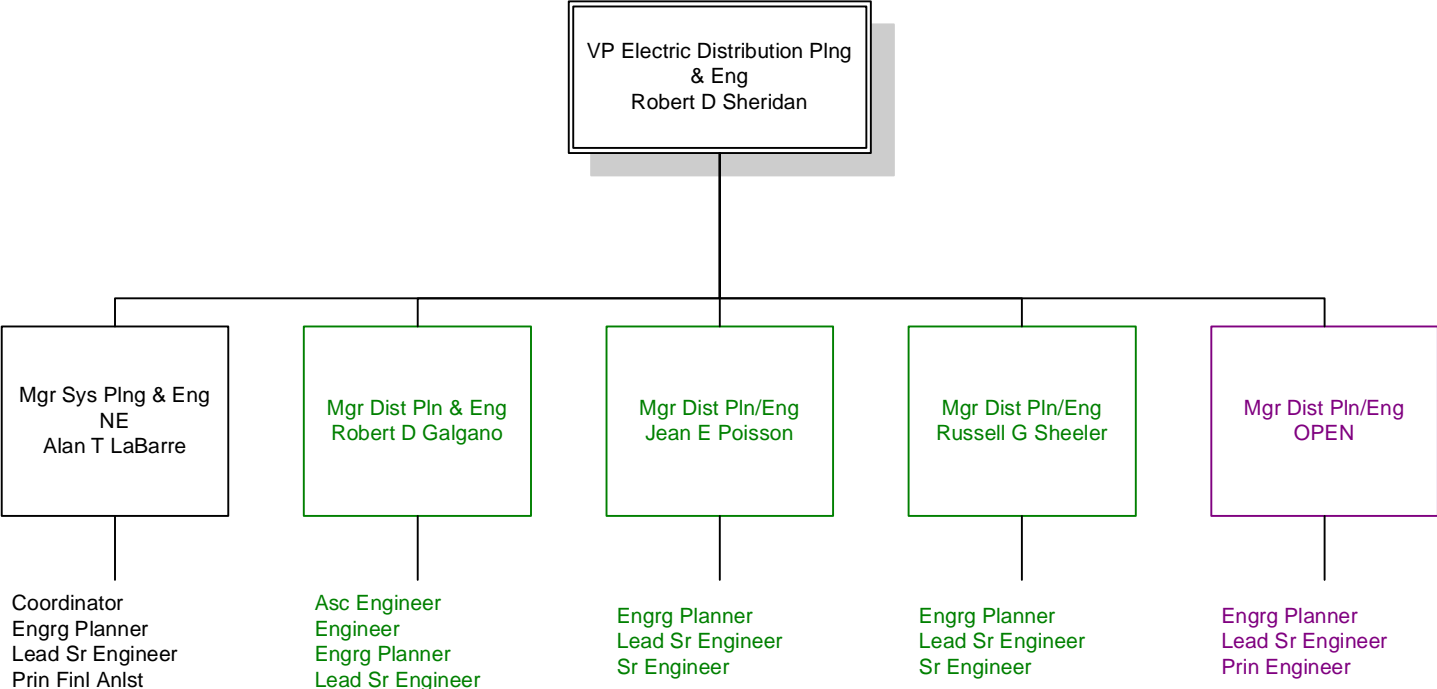

Customer Service

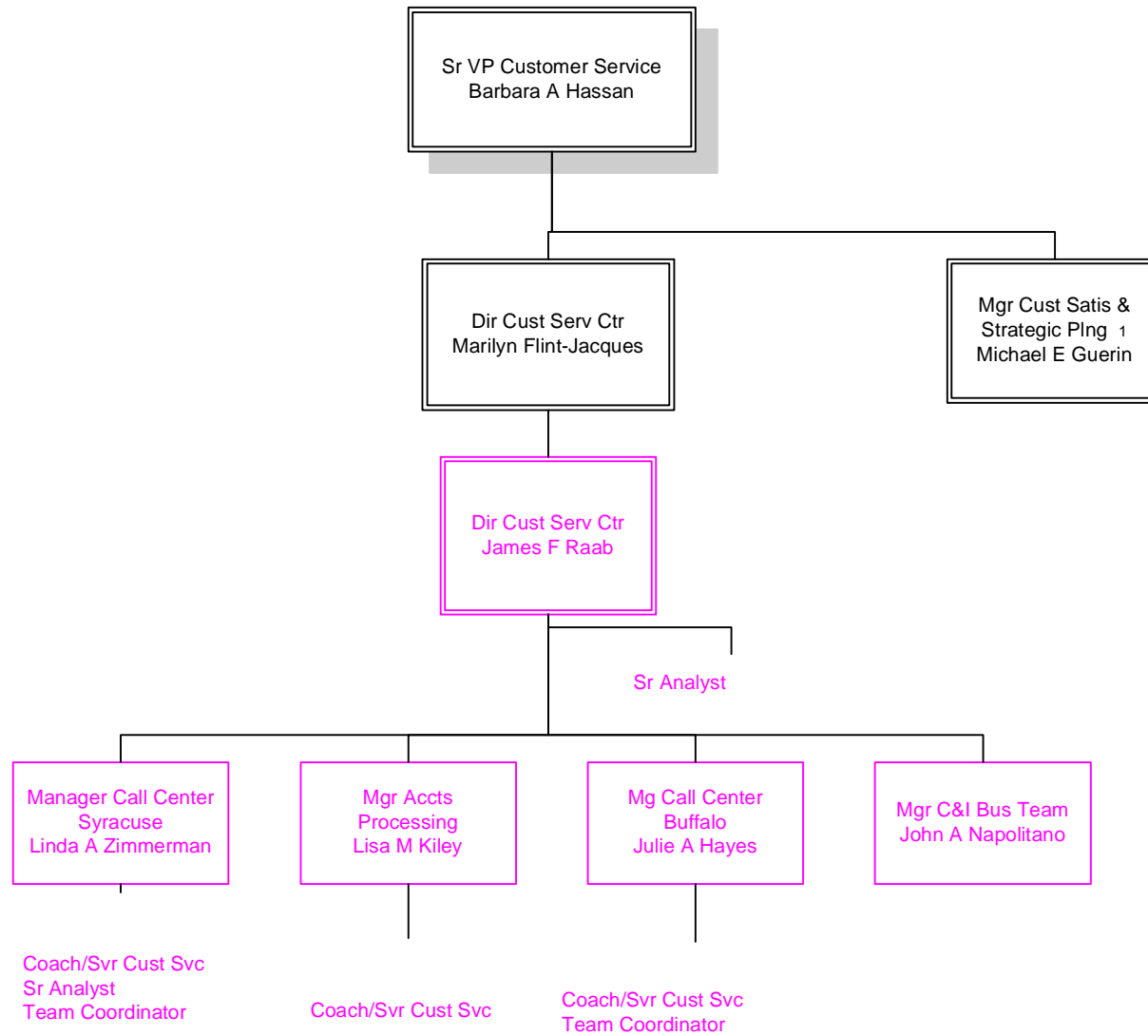

1. This function reports to the Customer Service Sr Vice Presidents for both New England and New York regions.

New England Distribution Finance

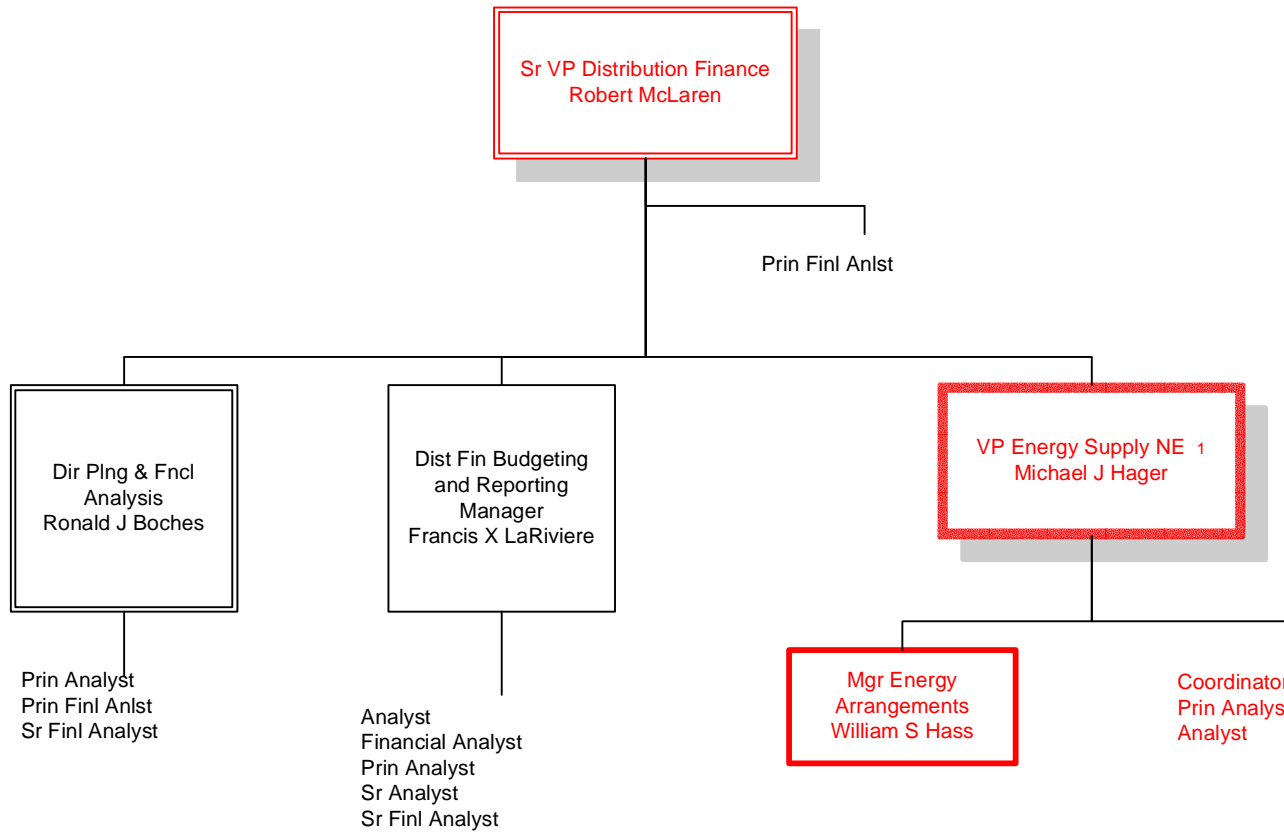

1. Energy Supply function is classified as part of the Sales and Marketing function.

NOTE: The positions and individuals depicted in red on this page are National Grid USA Service Co employees

Last Updated 09/17/04

Job Descriptions

New York Distribution

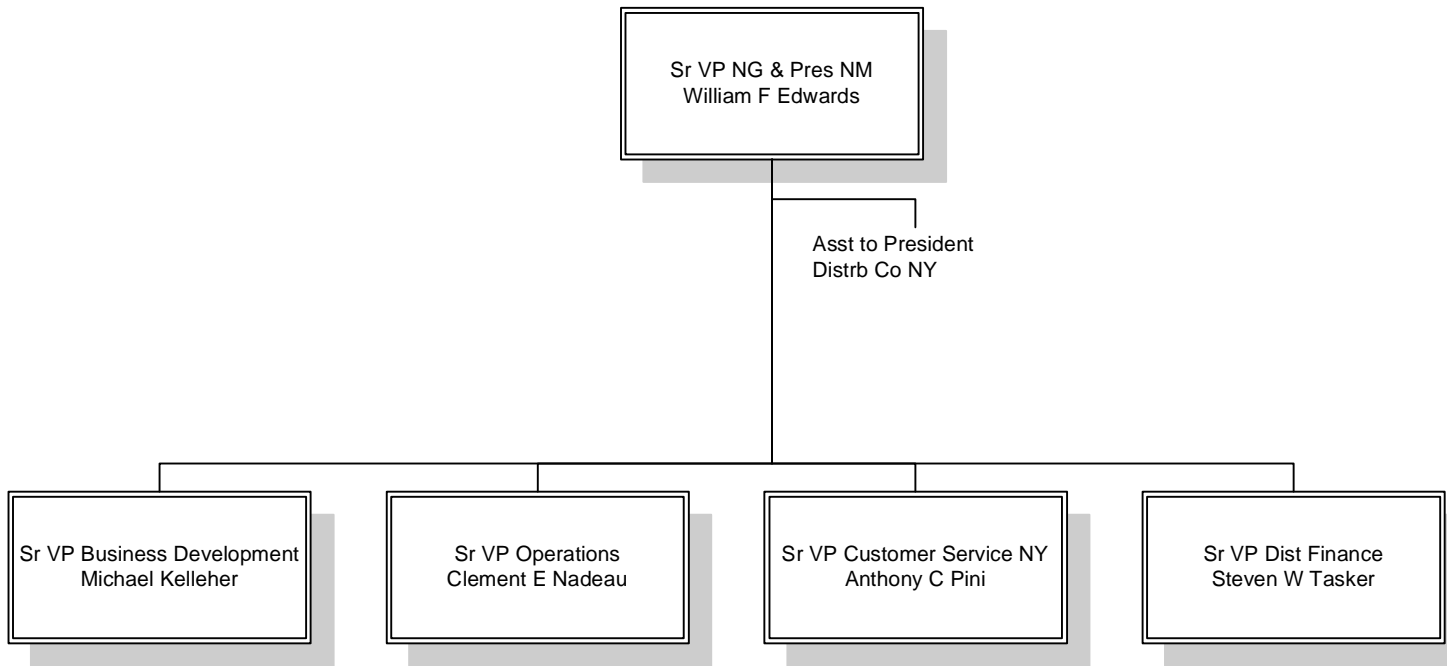

Business Services and Economic Development

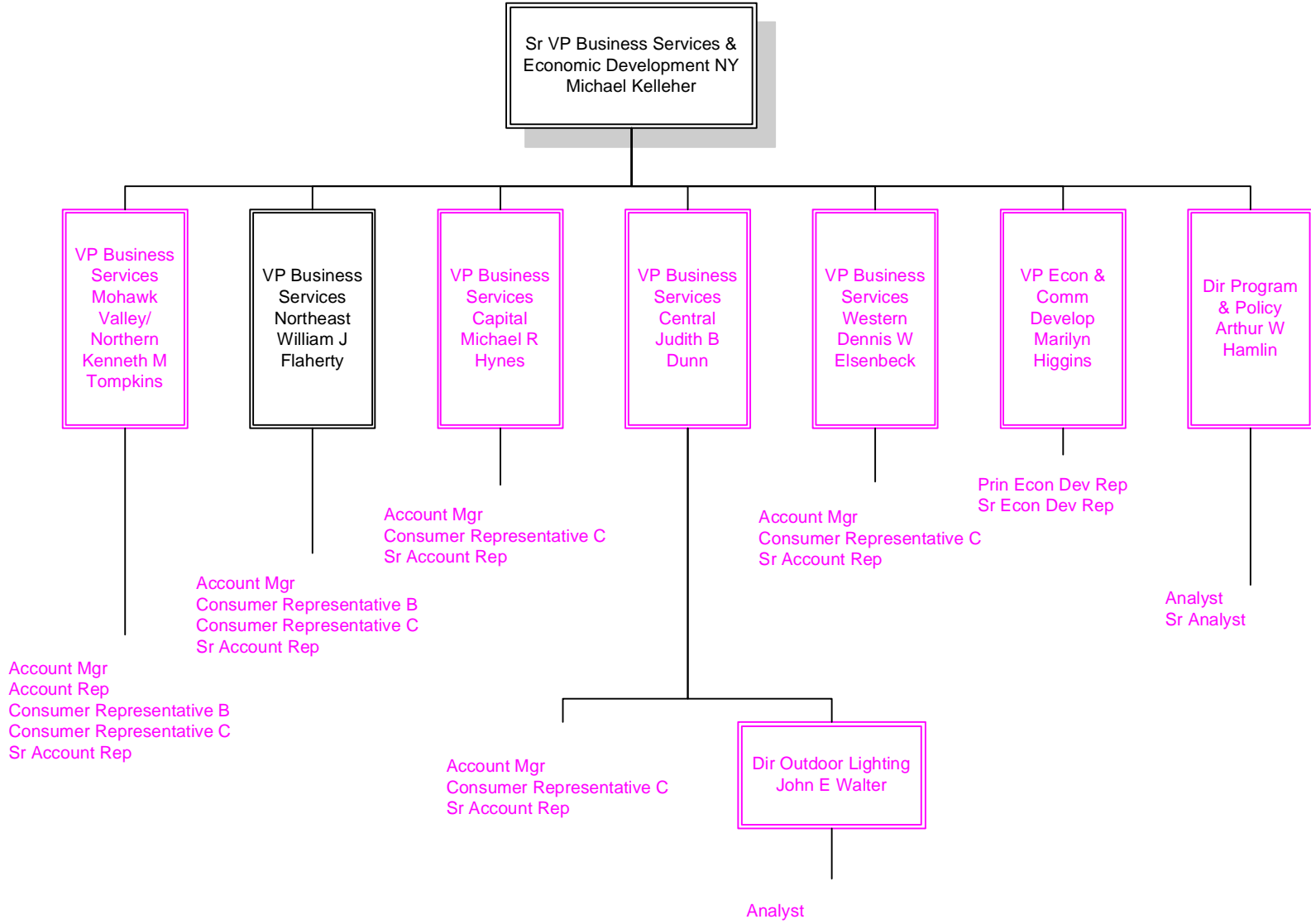

New York Distribution Dispatch and Control

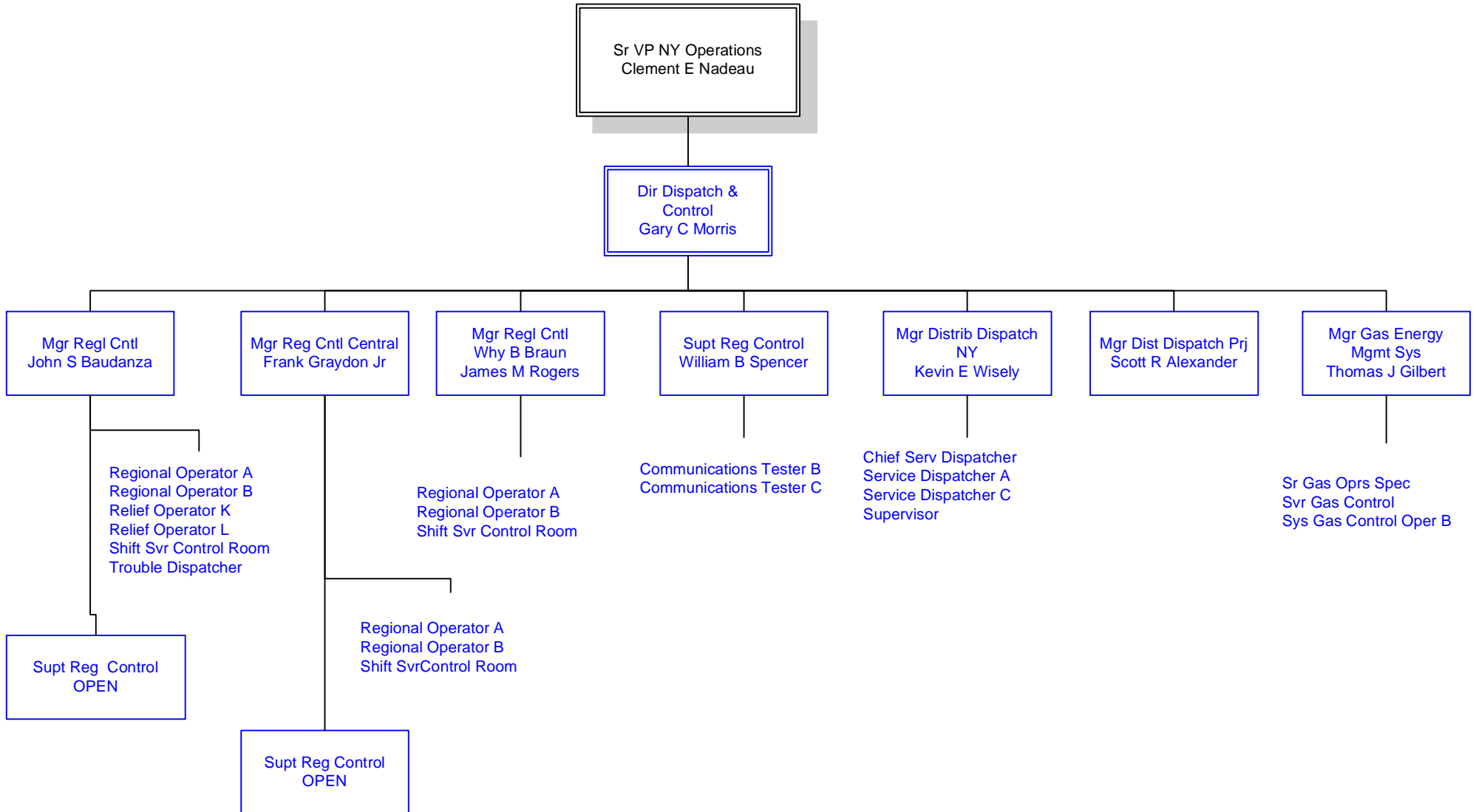

NOTE: The positions and individuals depicted in blue on this page are National Grid USA Service Co employees

Last Updated 11/02/04

Job Descriptions

New York Distribution Electric Distribution Planning and Engineering

VP Elec Dist Plng & Eng
Scott D Leuthauser

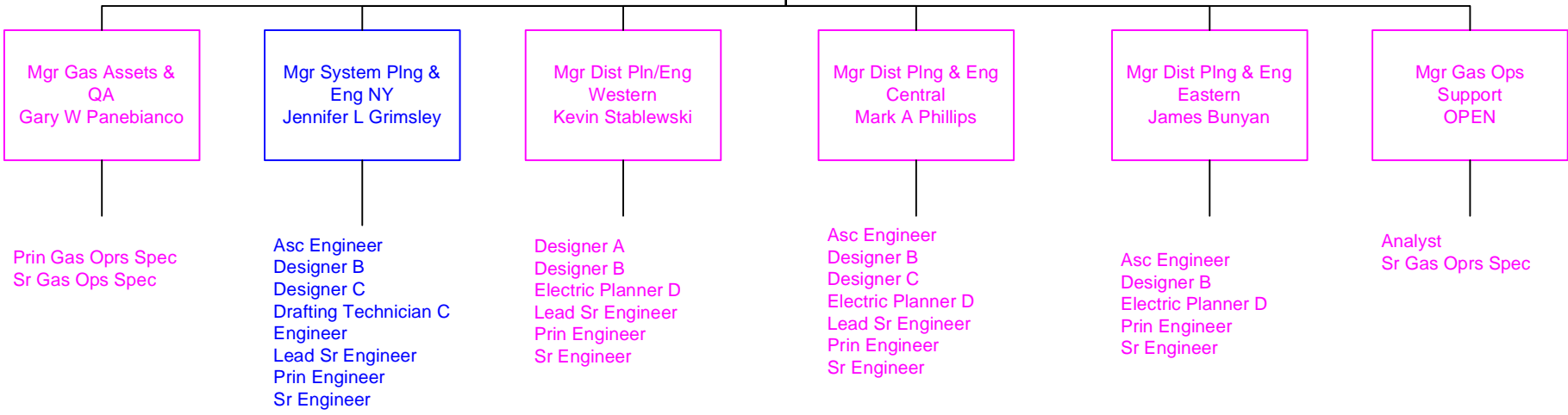

NOTE: The positions and individuals depicted in blue on this page are National Grid USA Service Co employees

Last Updated 10/12/04

Job Descriptions

New York Customer Service

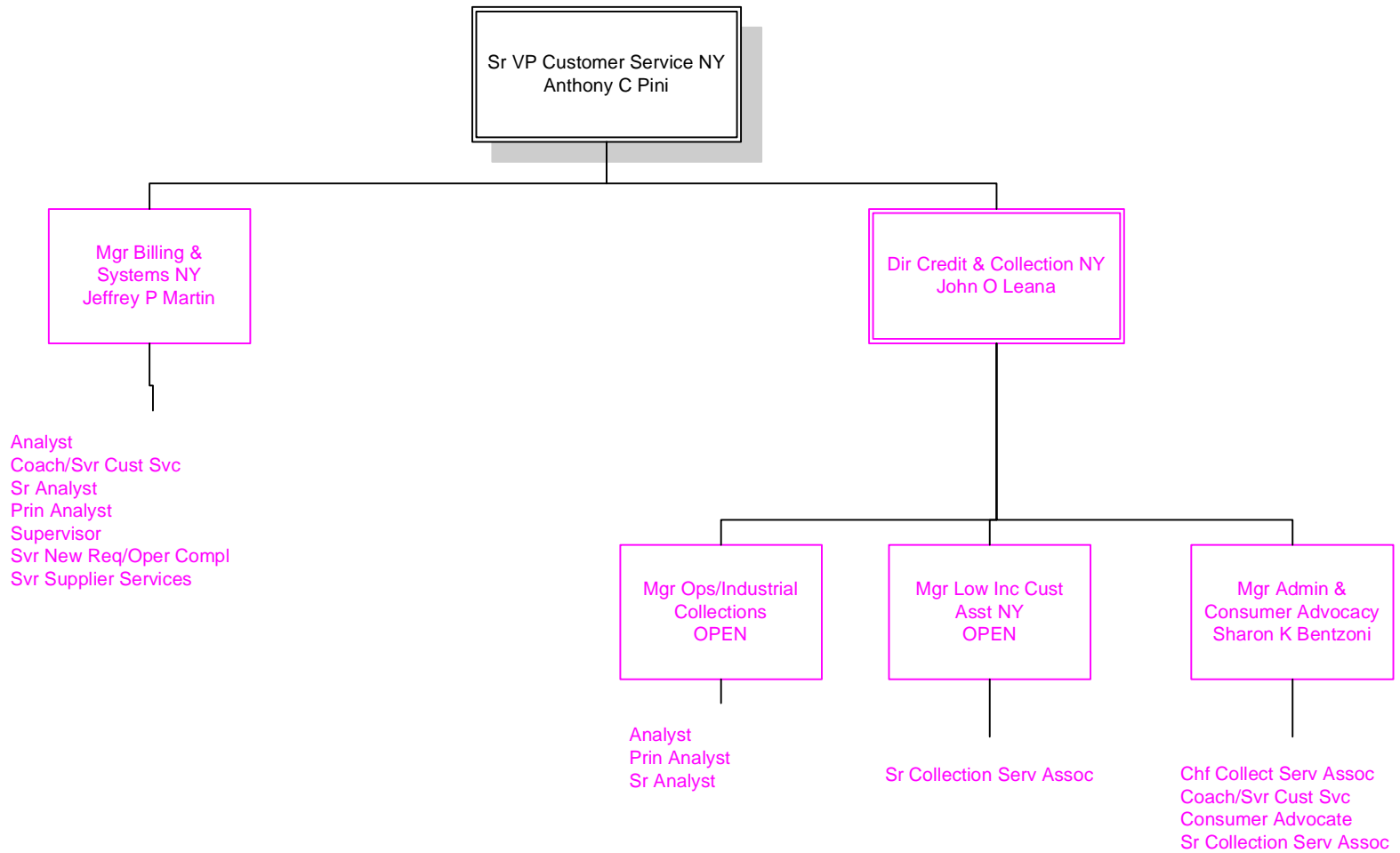

Customer Satisfaction and Strategic Planning and Support

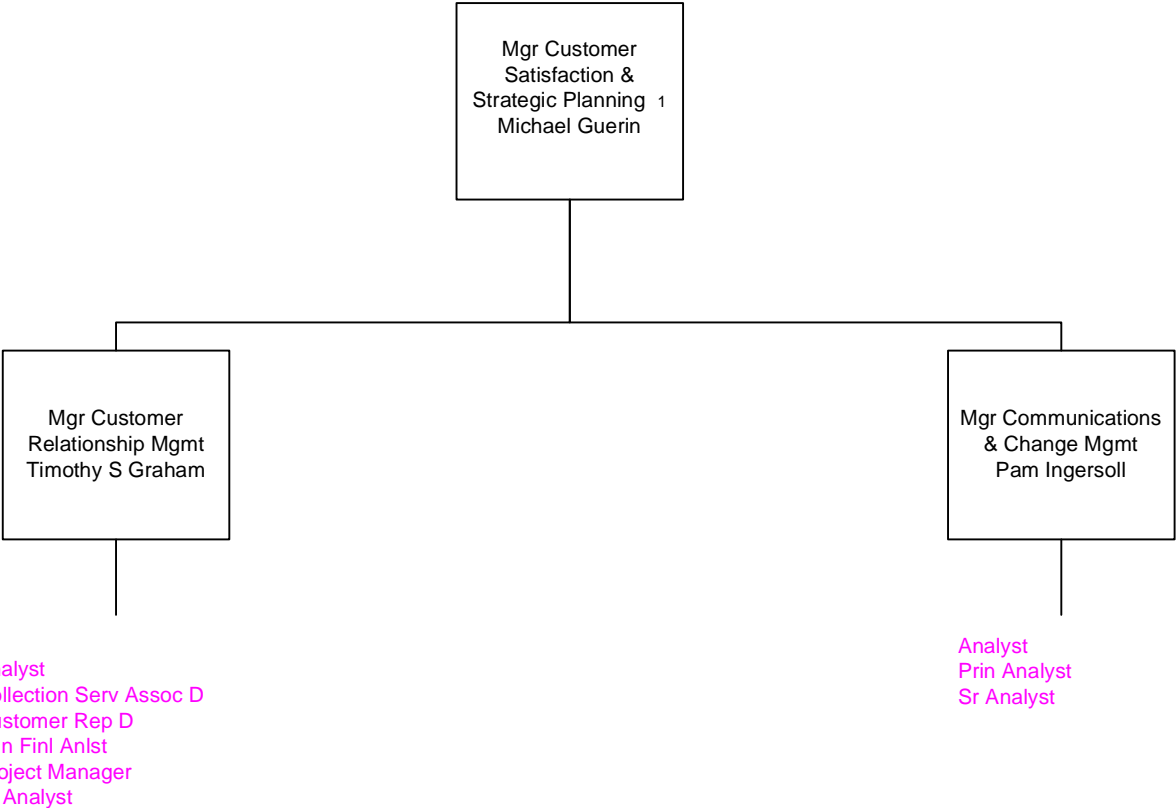

1. This function reports to the Customer Service Sr Vice Presidents for both New England and New York regions.

New York Distribution Finance

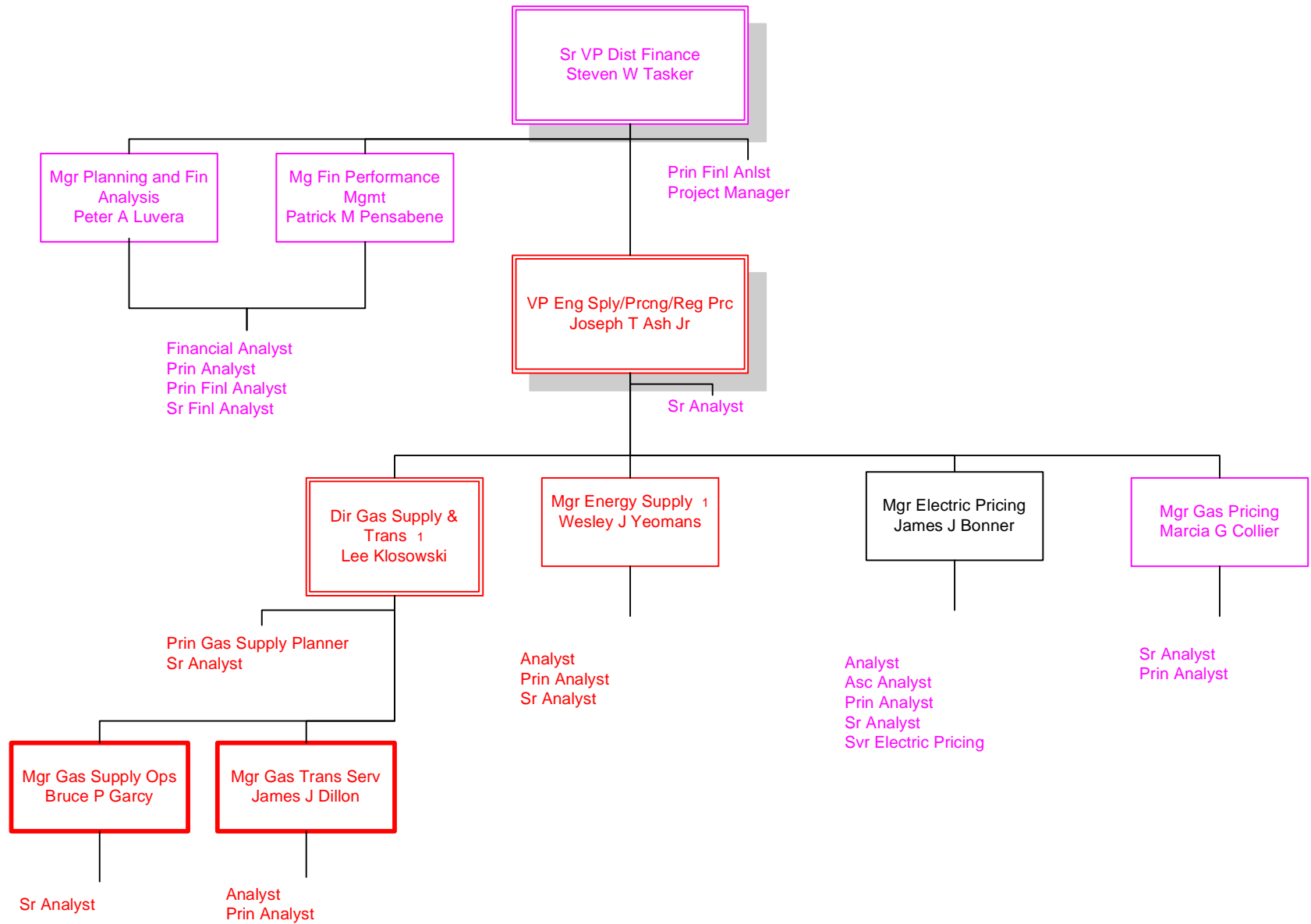

1 These functions are classified as part of the Sales and Marketing function

NOTE: The positions and individuals depicted in red on this page are Niagara Mohawk employees

Last Updated 09/17/04

Job Descriptions

Information Technology

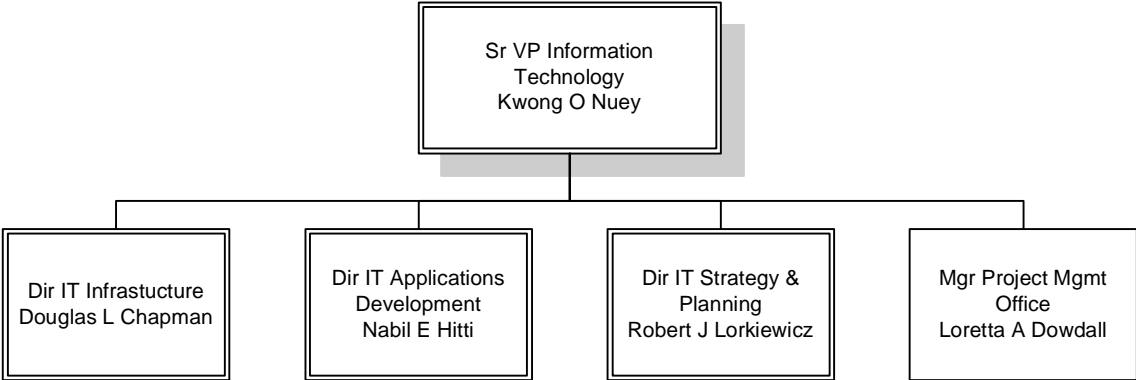

Information Technology Infrastructure

Dir of IT
Infrastructure
Douglas L Chapman

Dir Data Center
Services
Timothy M Corcoran

Mgr Data Center
Operations
Jay J Frey

Edp Console Oper A-T
Edp Console Operator B
Edp Equipment Operator B

Information Technology Application Development

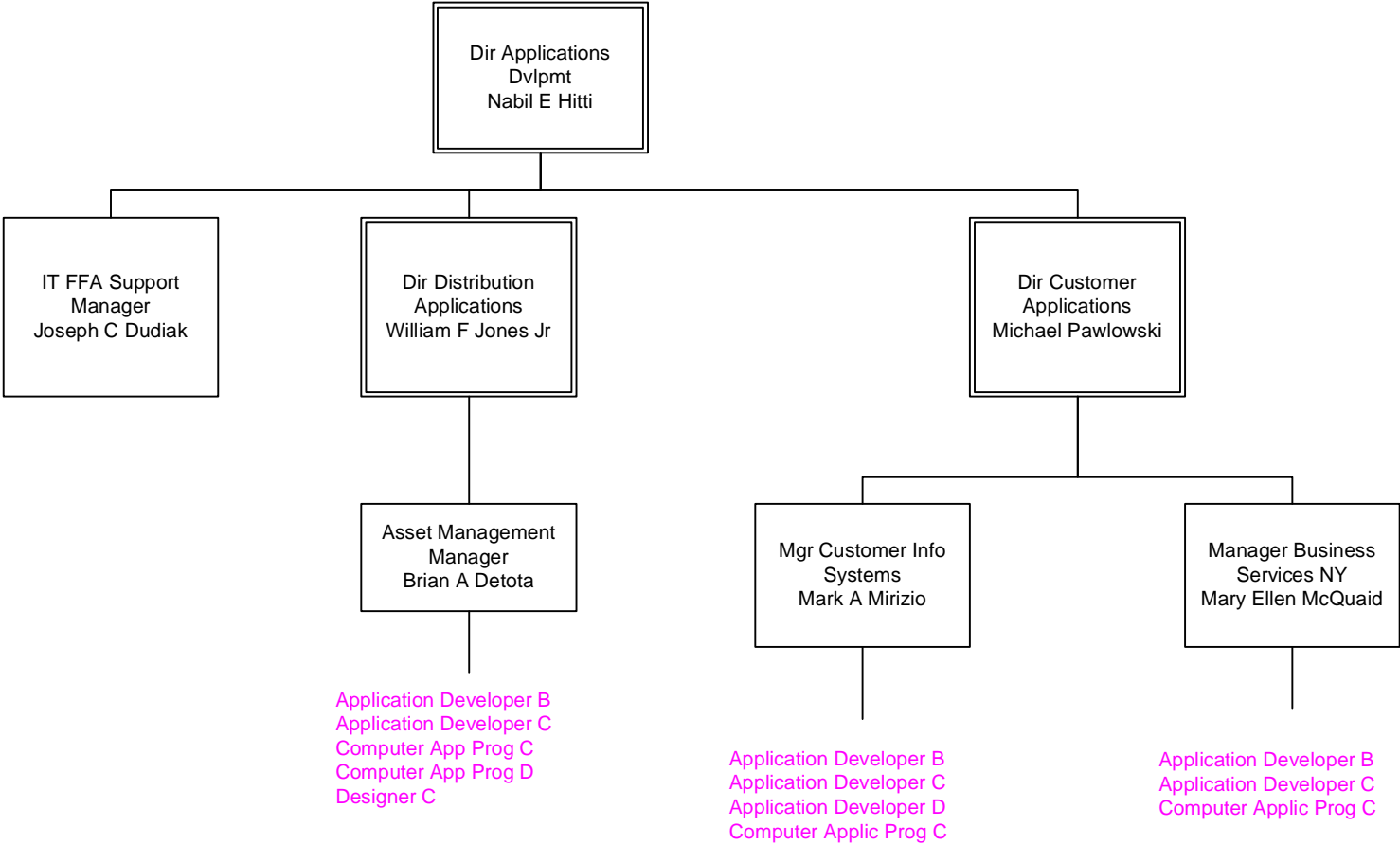

T&D Technical Services

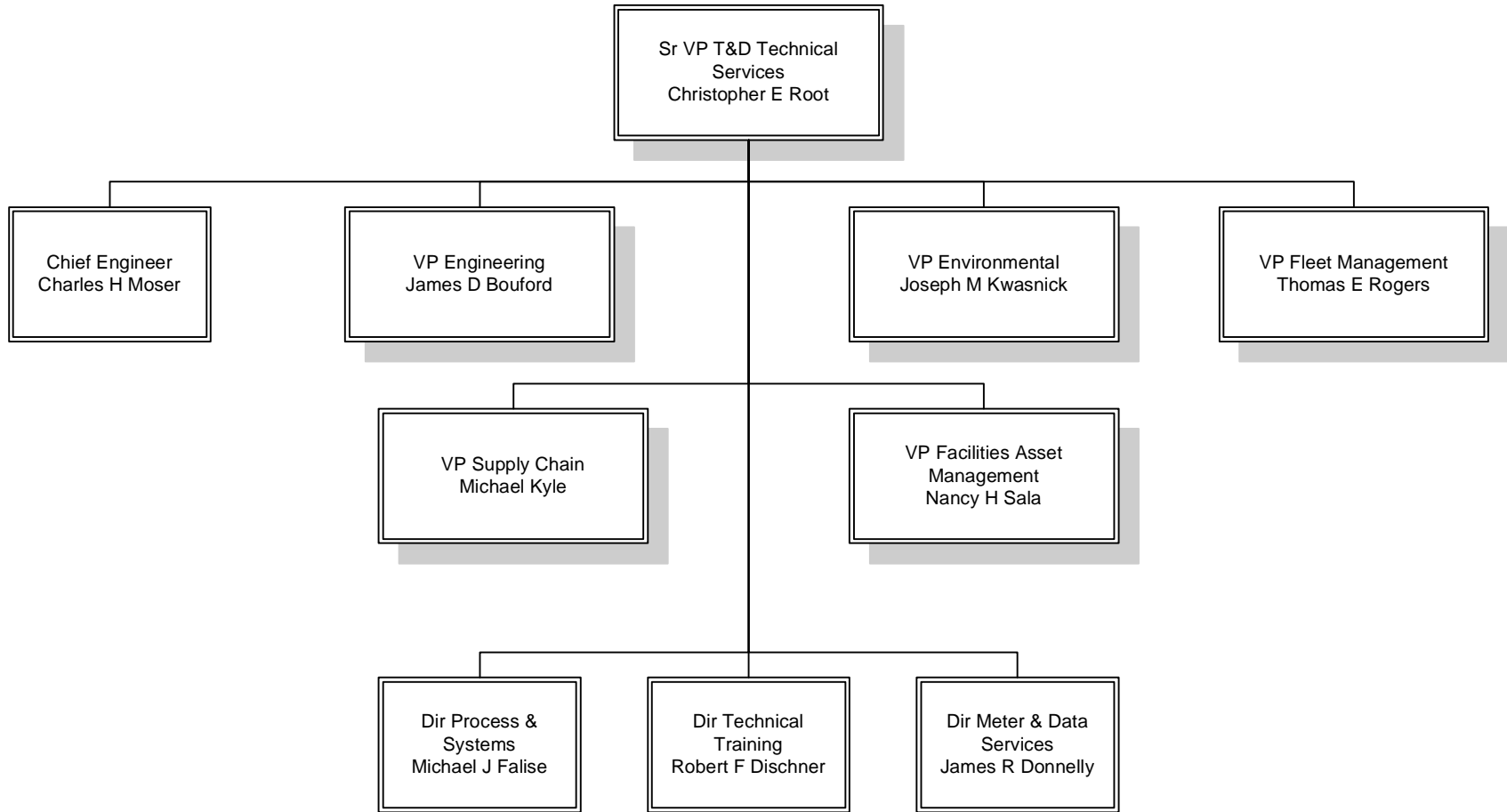

T&D Technical Services Engineering Services

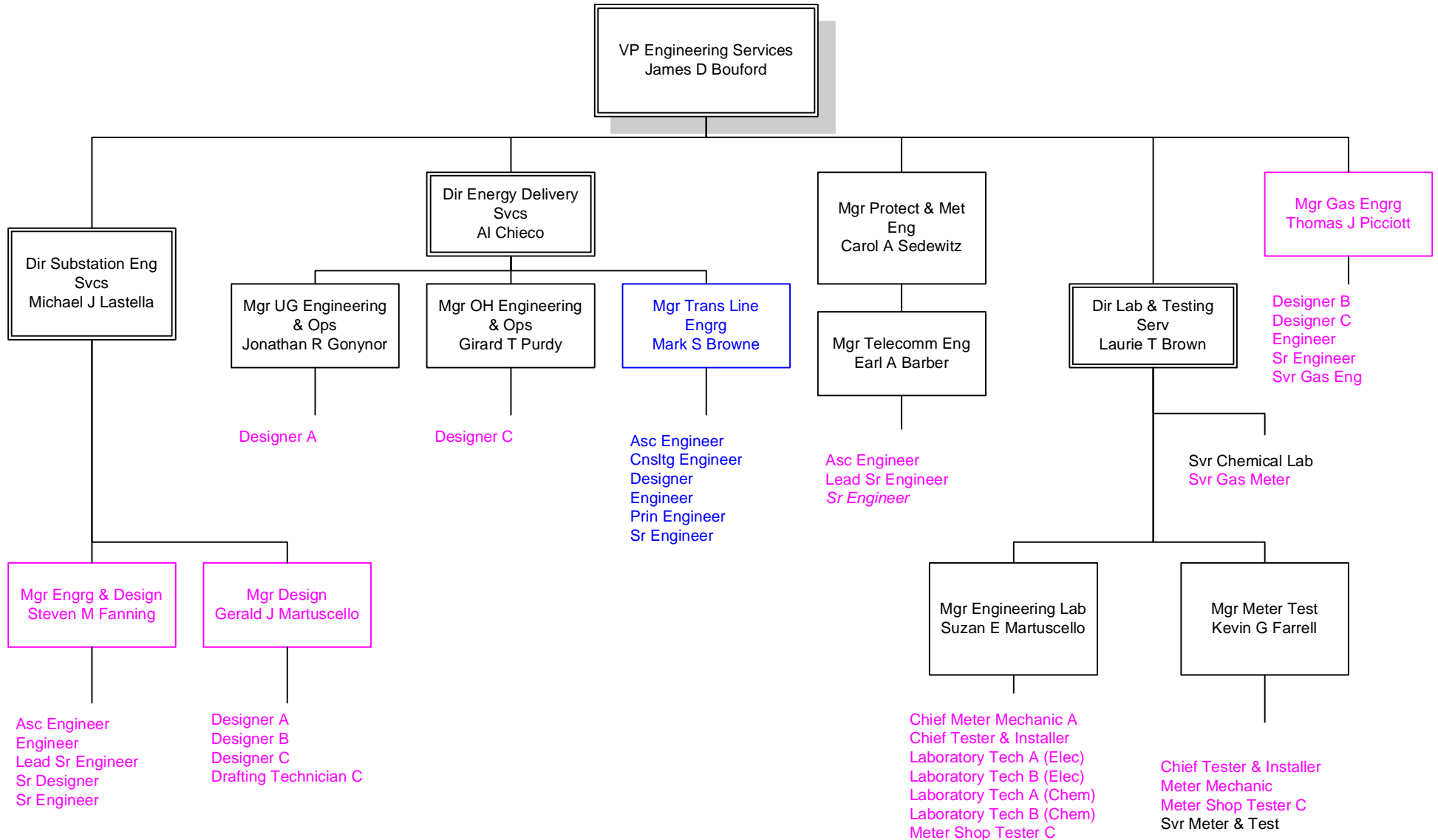

NOTE: The positions and individuals depicted in blue on this page are National Grid USA Service Co employees

Last Updated 10/12/04

Job Descriptions

T&D Technical Services Technical Training

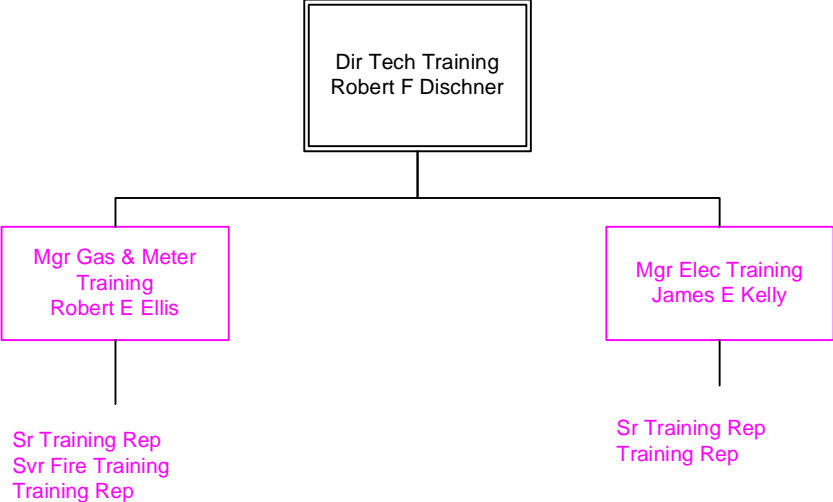

T&D Technical Services Environmental

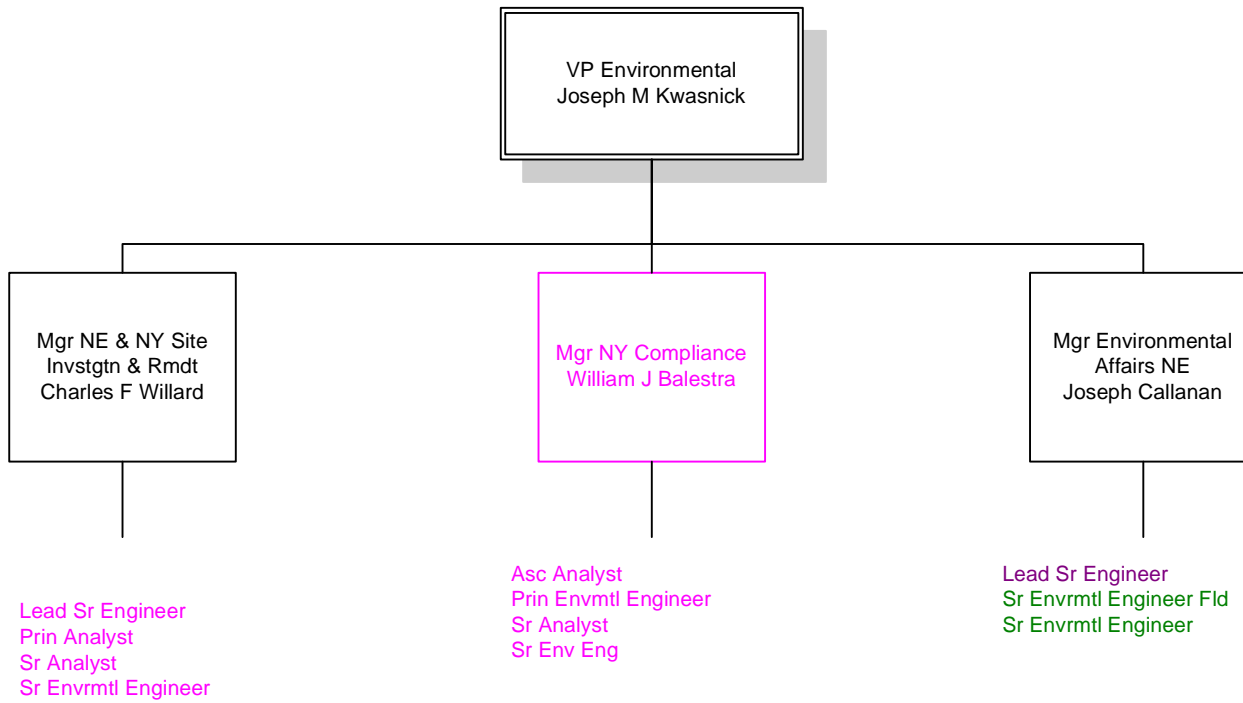

T&D Technical Services Process and Systems

Dir Process &
Systems
Michael J Falise

System Support
Manager
Brian J Miller

Blueprint & Photostat Oper B
Drafting Technician C
Plnt Invent Recorder A
Plnt Invent Recorder B

T&D Technical Services Fleet Management

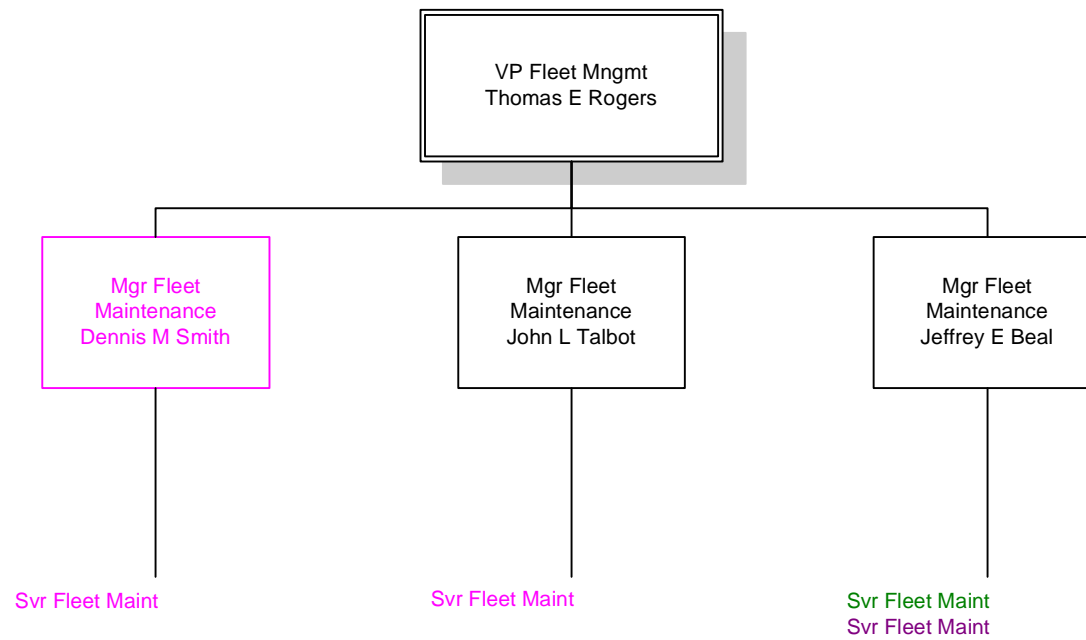

T&D Technical Services Supply Chain Management

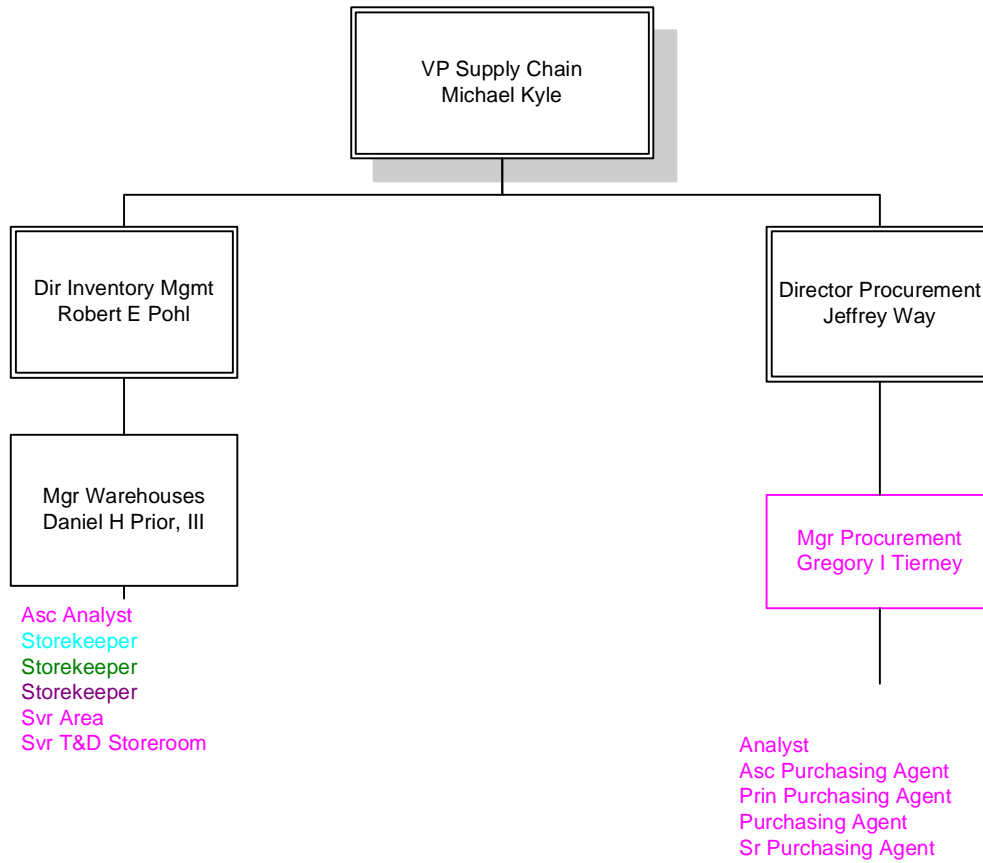

Property and Real Estate Management Facilities

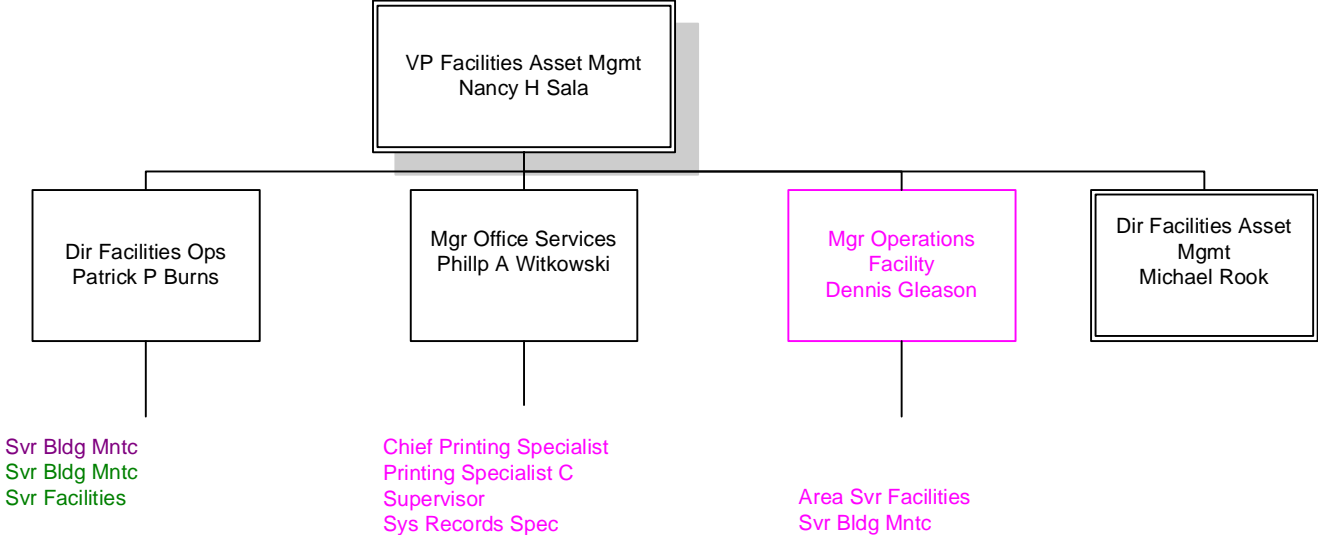

Business Development

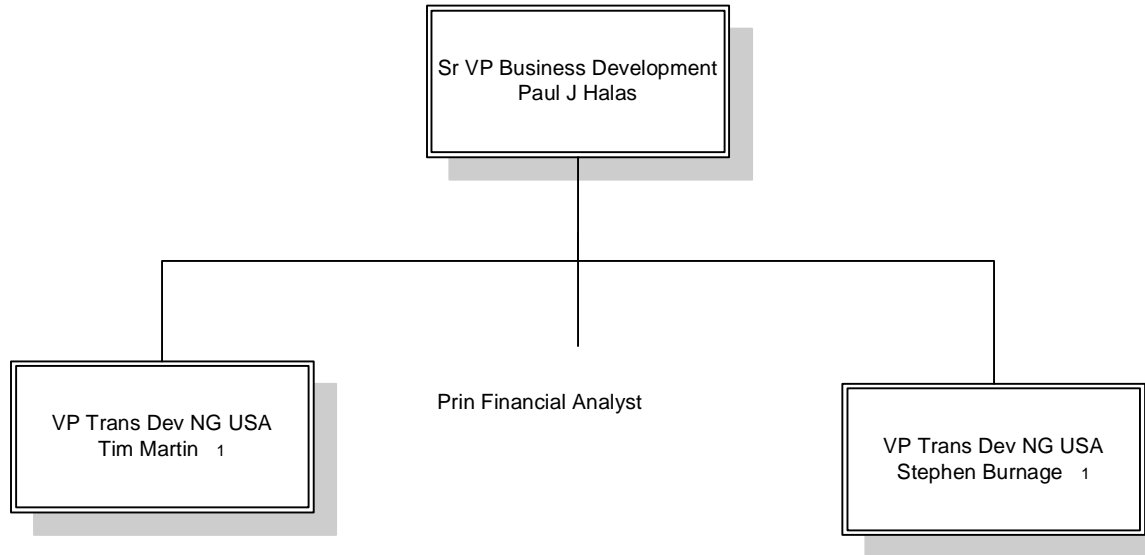

1 On assignment from the UK

Last Updated 09/17/04

Job Descriptions

Finance

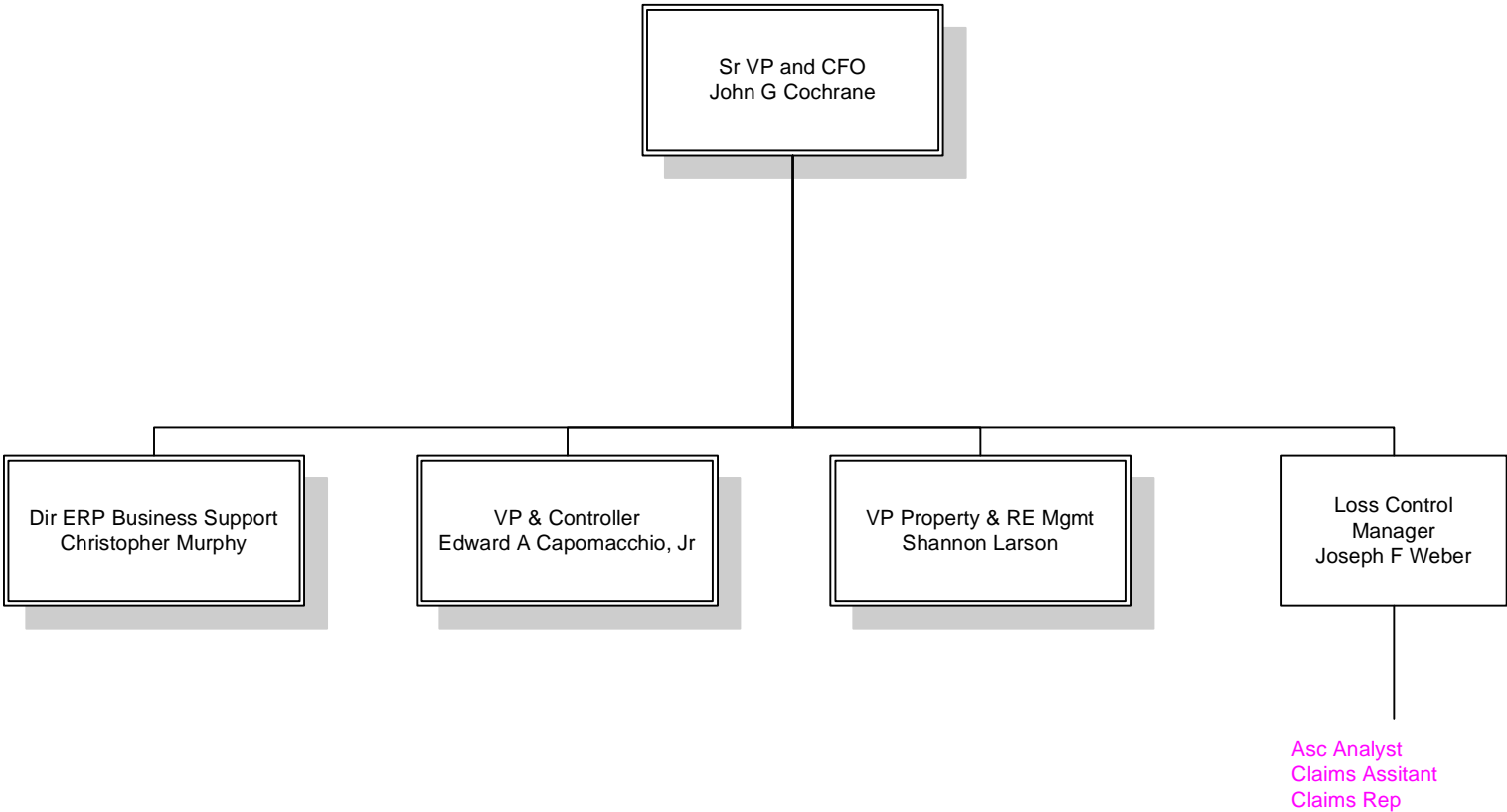

Finance Vice President & Controller

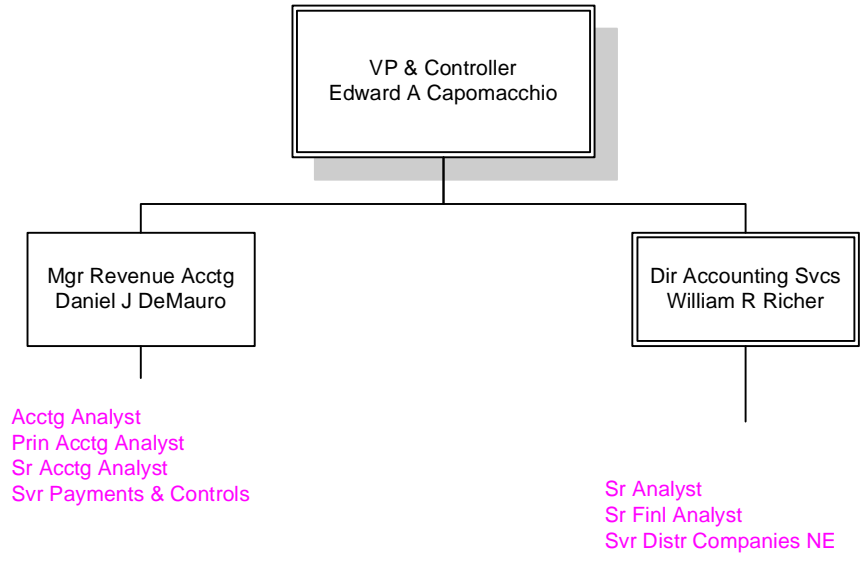

Real Estate Management and Property Tax

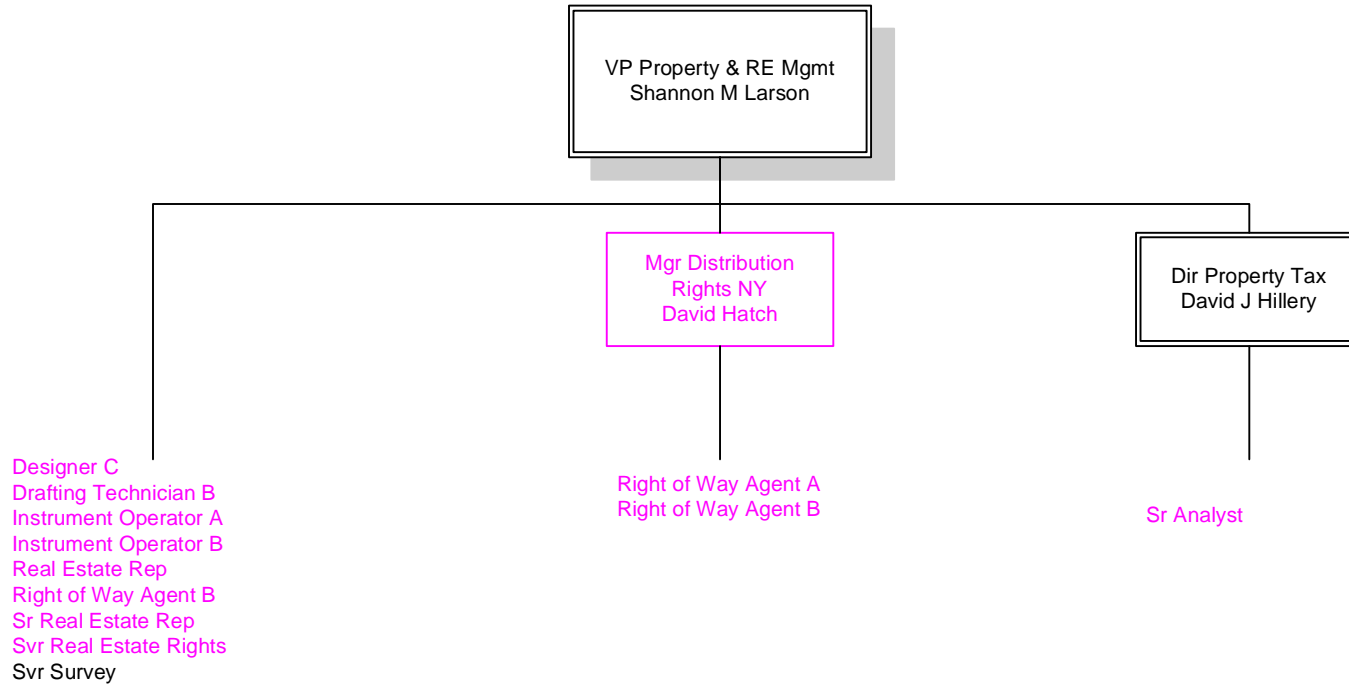

Human Resources

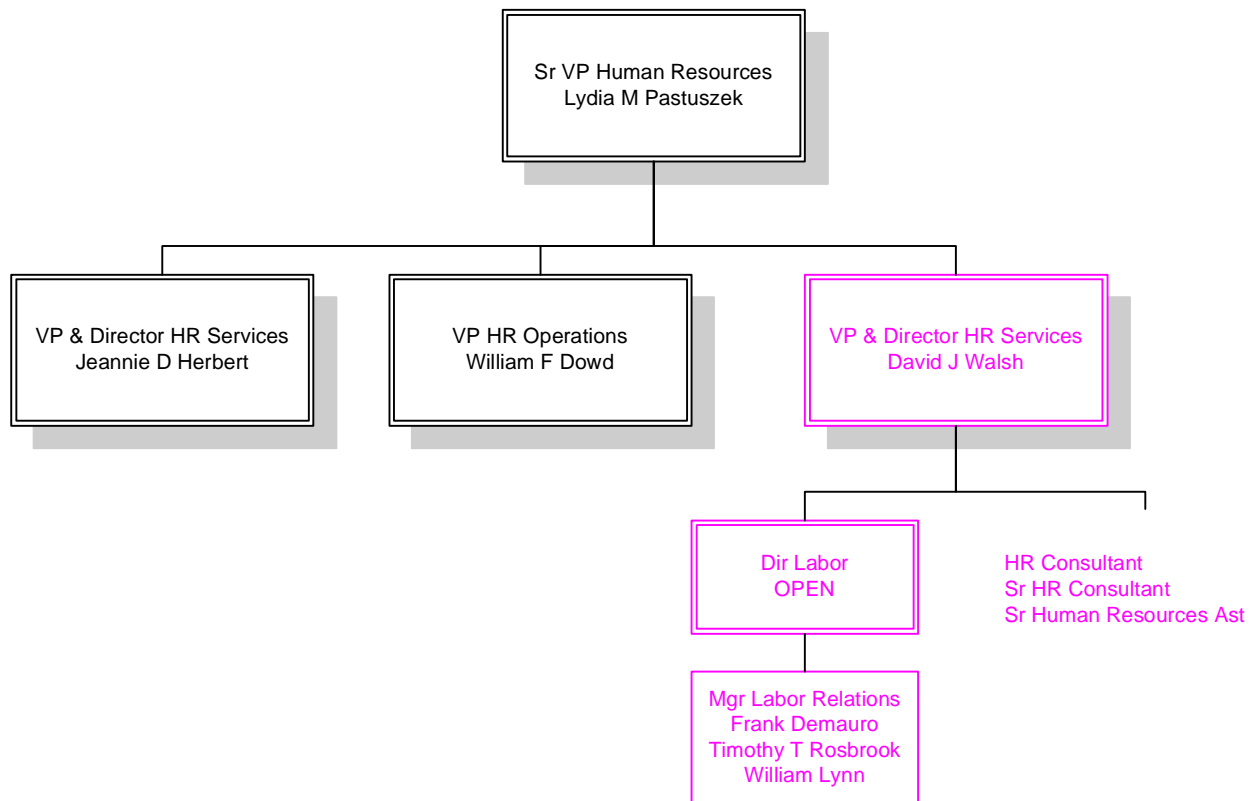

Legal and External Relations

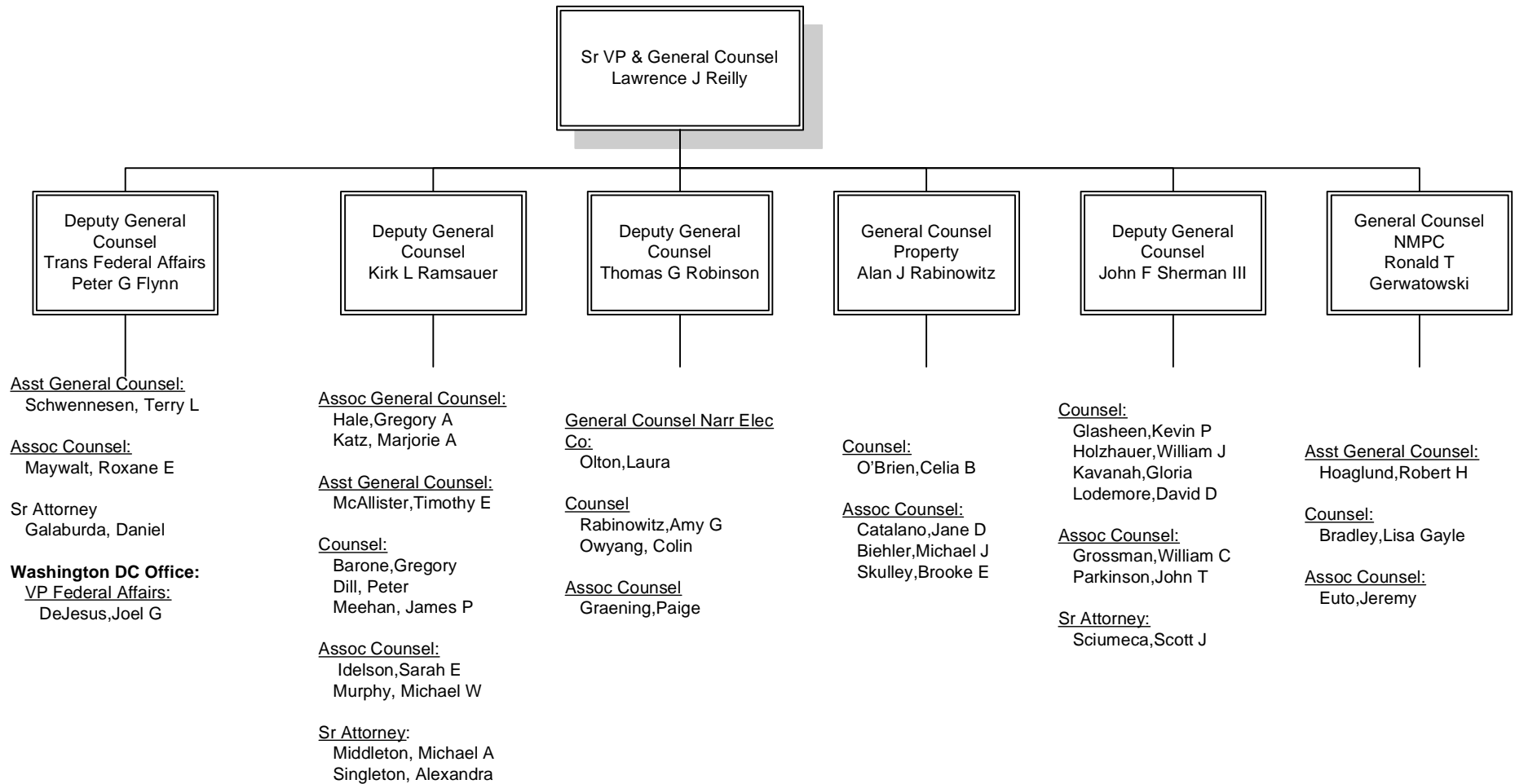

Legal and External Relations

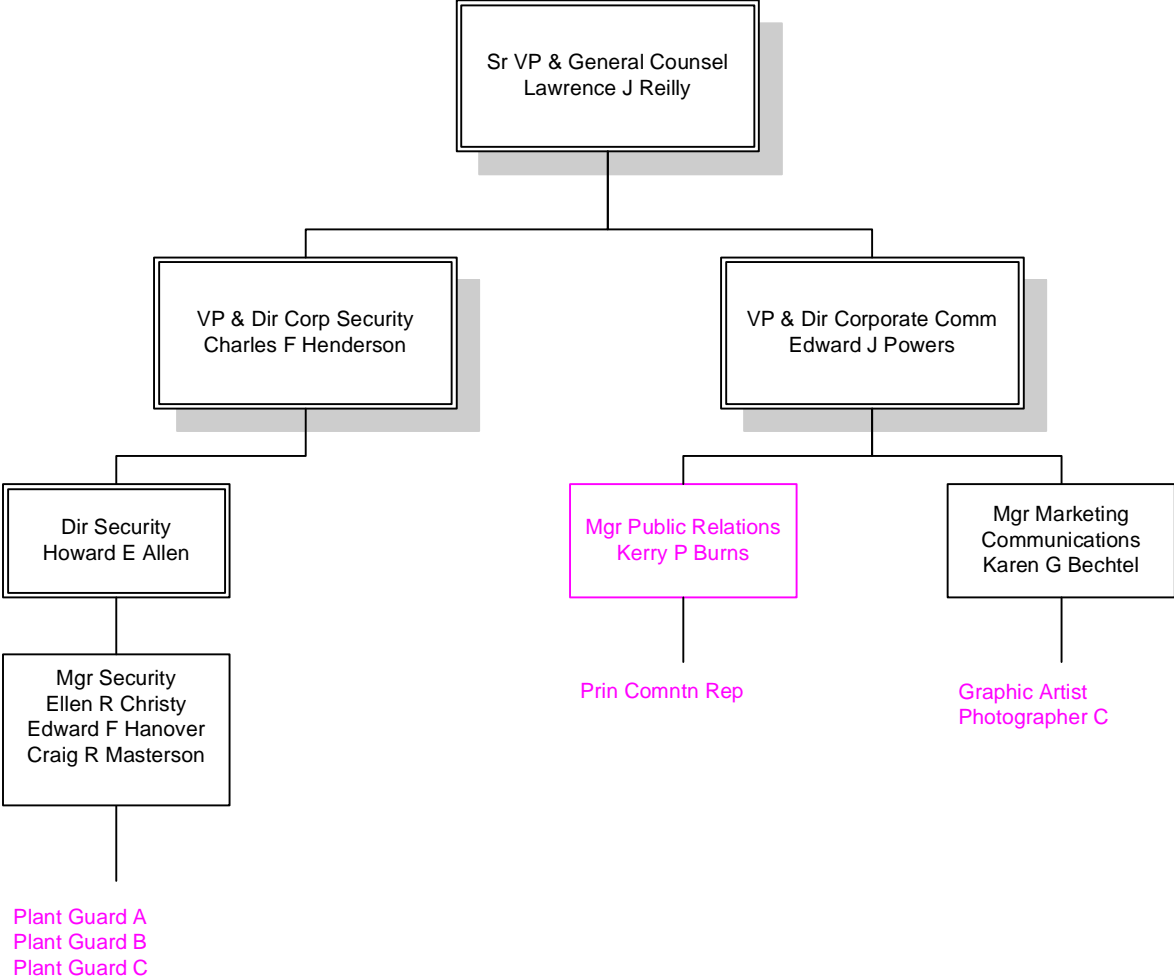

GridAmerica

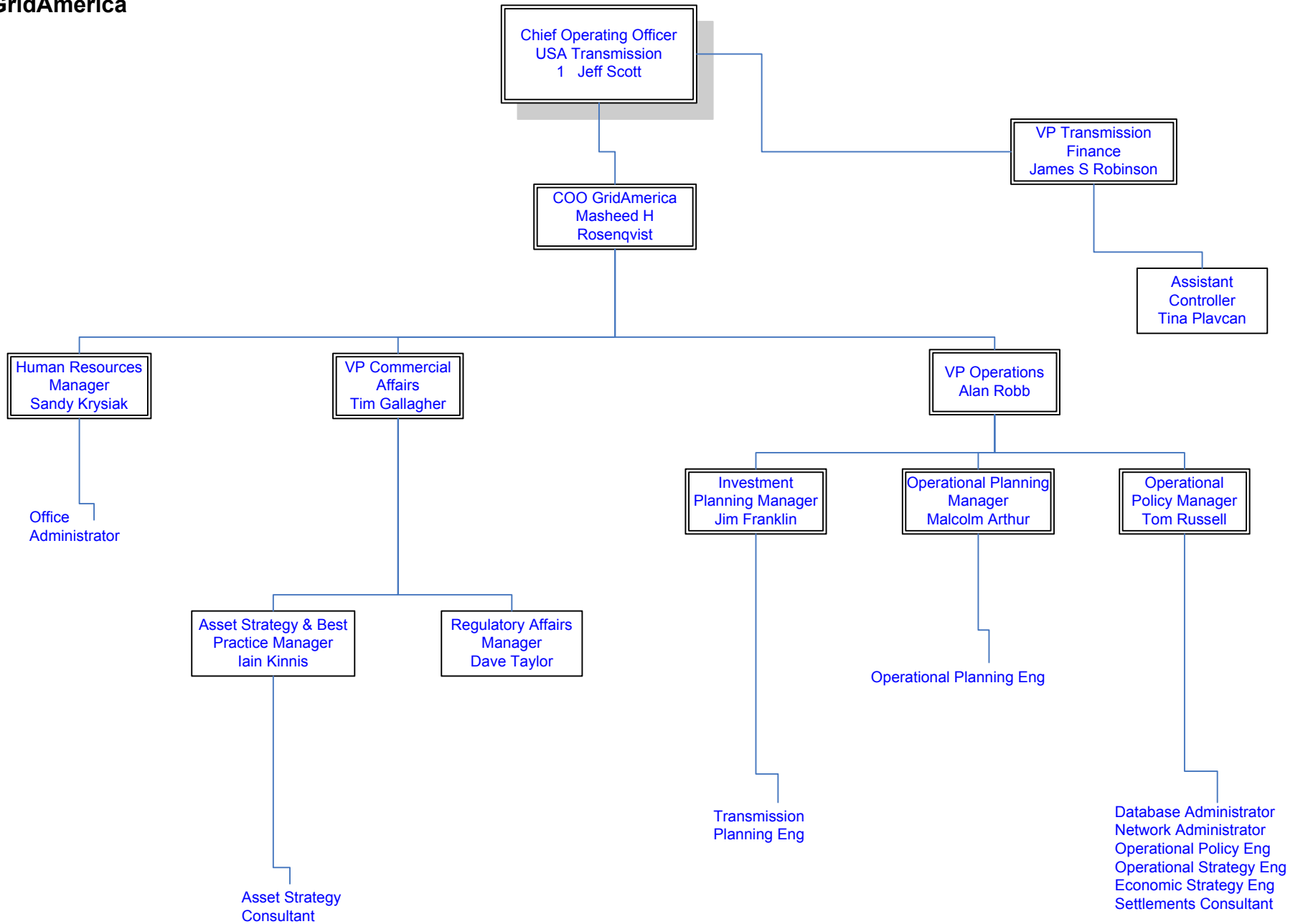

TRANSMISSION

Account Manager, Commercial Services, is the key point of contact for transmission customers in all respects related to the transmission services provided by National Grid.

Associate Analyst, Commercial Services, serves as contract and economic analyst to support regulatory contracts and contract databases for over 1000 transactional documents that evidence the revenue stream for the transmission business.

COO GridAmerica, responsible for the overall operation of GridAmerica, including creating, implementing and monitoring operational goals as well as strategic business planning.

COO US Transmission, has primary responsibility for the overall planning, operations and control of the transmission system and is responsible for the profitability of the US Transmission business unit.

Director Regulatory Policy, responsibility for developing US wide regulatory strategy with a focus on FERC relationships, as well as NE regulatory processes.

Manager Market Development, manage market-related areas pertaining to regulation and industry policy for National Grid's US transmission business.

Principal Analyst, Regulation and Commercial, provide analyses for regulatory and business strategy development; represent National Grid in industry committees.

Principal Engineer, Commercial Services, is the key point of contact for transmission customers in all respects related to the transmission services provided by National Grid and has other process related duties related to transmission transaction management, customer outreach and educations along with and technical advisory roles.

Principal Engineer, Regulation and Commercial, provide analyses for regulatory and business strategy development; represent National Grid in industry committees.

VP & Director Regulation and Commercial, direct areas pertaining to regulation and industry policy for National Grid's US transmission business.

VP Network Asset Management, leads the development of policy, strategy and planning for transmission asset management and manages service provider–asset steward relationships for design, construction, maintenance and operations of transmission assets to optimize the long-term security and delivery capability of the transmission system that is cost-effective, safe and environmentally sound.

VP Network Operations, is responsible for the safe, reliable and effective operation of National Grid's Northeast Transmission System.

VP Northeast Transmission, oversees the management and the system control of transmission assets. This position is responsible for commercial services to major transmission customers and network operations of the transmission system.

VP State Regulatory Relations, coordinate with state government and state agencies pertaining to regulation and industry policy for National Grid's US transmission business.

VP Transmission Commercial Services, responsible for transmission customer relations including contracts, tariffs, contract negotiations and Federal regulatory compliance.

VP Transmission Finance, is responsible for financial analysis, internal reporting, budgeting and forecasting, contract and tariff billing, rates and business planning activities for National Grid USA's transmission operations in New England and New York Also responsible for financial analysis, internal reporting, budgeting for the US Interconnector (HVDC link with Canada) and GridAmerica LLC.

TRANSMISSION FINANCE

Analyst, Energy Measurements & Billing (this includes Senior Analyst), responsibility for on-going contract administration related to NEP's transmission tariff, grandfathered contracts, generator interconnections, FERC filings and the US Interconnector.

Analyst, Reporting, Analysis & Forecasting (this includes Senior, Principal Analyst and Principal Financial Analyst), supports the internal reporting and budget and forecasting activities for National Grid USA's transmission operations in New England and New York, in addition to supporting the US Interconnector. Provide guidance whenever needed to organization to ensure that the transmission segments financial data is accurate. This includes reviewing all transmission-related direct expenses and service company allocations and will require working with individuals across the organization to ensure that information is captured and reported accurately.

Assistant Controller, GridAmerica, responsible for performing and/or directing GridAmerica's accounting functions. These functions include establishing and maintaining accounting policies, practices and procedures. Also assists the VP of Finance in the preparation and evaluation of budgets and other financial operating reports.

Manager Energy Measurements & Billing, is responsible for developing and policies and procedures to ensure an appropriate level of internal controls over contract administration and transmission billing. This includes reviewing transmission billing for compliance with billing methodology documented in the various transmission contracts. Also support Commercial Services as a liaison between transmission customers and account managers.

Manager Transmission Rates, is responsible for administration of company rates, tariffs and company-specific components of regional Open Access Transmission associated with National Grid USA's transmission operations in New England and New York. Also supports tariff and regulatory activities for GridAmerica LLC.

Manager Transmission Reporting, Analysis & Forecasting, is responsible for financial analysis, internal reporting and budget and forecasting activities for National Grid USA's transmission operations in New England and New York. Also responsible for internal reporting, budgeting and forecasting for the US interconnector.

Principal Analyst, Transmission Rates, is responsible for independent evaluations and analyses in order to provide strategic information in support of company rates, tariffs and company-specific components of regional OATTS; develops and recommends solutions in support of ratemaking; performs in-depth analyses in support of regulatory litigation regarding tariffs; represent the company in various committees; prepare and present regulatory testimony in support of various ratemaking activities.

Senior Analyst and Senior Rate Analyst, Transmission Rates, is responsible for various economic analyses in support of tariffs and/or contracts; preparation of transmission tariff terms and conditions; modification and development of regulatory agreements; and perform analyses in support of other company functions.

TRANSMISSION NETWORK PLANNING AND OPERATIONS

Consulting Engineer, Network Asset Management, serves as project coordinator and facilitator for permitting and licensing activities for a portfolio of customer related and capital plan transmission projects to serve both customer and asset health needs of the enterprise.

Coordinator, Network Services Delivery, interface closely with T&D Technical Services and operating divisions representing the Transmission business in the development and operation of Network Services Delivery processes for work plan development and delivery.

Director Network Services Delivery, is responsible for the Phase I and Phase II facilities including O&M budgets for three companies, operations and maintenance.

Director Transmission Network Planning and Development, manages planning, systems engineering and operations support of the National Grid USA bulk transmission assets.

Engineer, HVDC Operations (this includes Principal and Senior Engineer), responsible for controls, protections and equipment for the HVDC converter terminals.

Engineer, Network Planning and Development (this includes Senior, Principal, Lead Senior and Consulting Engineer), conduct analytical studies for transmission system expansion, interconnection of new generation, and load to the transmission system. The engineer is also responsible for application engineering for all major transmission equipment.

Forester (this includes Senior Forester), carry out field level implementation of the transmission vegetation management program. Duties include planning, budgeting and auditing the NG right-of-way vegetation management program.

Maintenance Technician, HVDC Operations (this includes Senior Maintenance Technician) maintains the station equipment in the converter terminals.

Manager Network Asset Strategy, responsible for the development of policy, strategy and processes for Transmission Network Asset Management to optimize the long-term security and delivery capability of the transmission system that is cost-effective, safe and environmentally sound.

Manager Transmission Forestry Strategy, optimize transmission system safety and reliability performance by developing and implementing right-of-way and substation vegetation management programs. Deliver responsive and cost-effective service in compliance with applicable safety and environmental regulations and company policies.

Network Operators, HVDC Operations, is responsible for the bulk power transfers between Hydro-Quebec and New England. This person operates the HVDC terminals in both Quebec and New England.

Planner, HVDC Operations (this includes Comerford Planner), plan and prepare the maintenance schedule, ensure necessary parts and equipment are available to complete the maintenance work for the HVDC facilities.

Principal Analyst, Network Services Delivery, monitor the service partners to determine compliance with work plan completion targets and letter of assurance requirements.

Senior Analyst, Asset Strategy, responsible for the administration of the Transmission line construction schedule, including analysis of Transmission business' overall investment schedule covering the short-term planning horizon.

Senior Analyst, HVDC Operations, prepare and analyze the O&M business plan and budget; review actual operating expenses such as payroll, overtime, material and vendor costs; compile monthly variance reports and update forecasts as needed.

Senior Analyst, Networking Planning and Development, maintain, analyze and report Transmission Asset investment information and technical data; maintain and report applicable project schedule and cost information.

Senior and Principal Analyst, Asset Strategy, develop and set policy, strategy and processes for asset replacement, system spares, engineering and maintenance of all classes of Transmission's line assets consistent with Transmission's business strategy.

TRANSMISSION NETWORK PLANNING AND OPERATIONS

Supervisor Maintenance, HVDC Operations, plans and directs the maintenance activities at the Sandy Pond and Monroe HVDC converter terminals.

Supervisor Operations, HVDC Operations, directs the operation of the Phase I (690 MW) and Phase II (2000 MW multi-terminal) HVDC facilities.

TRANSMISSION NETWORK OPERATIONS

Analyst, Operational Planning and Review (this includes Senior Analyst), assist in maintaining a Transmission outage plan that meets the requirements of internal customers for access to the Transmission system, ensures overall system security and is also optimized to both identify transmission congestion costs and to manage these costs within the agreed budget.

Coordinator Transmission Dispatch, Control Center NE, coordinates and schedules short term transmission outages while maintaining system security in New England.

Engineer, Operational Planning and Review (this includes Senior Engineer), coordinates and schedules outages, follow-ups on and learns from system disturbances, and enhances outage data provision within the organization. Monitors and benchmarks network performance, tracks and reports on network performance KPI's, and facilitates reliability data provision within NTB.

Manager, Control Center NE, monitors, controls, and operates National Grid's transmission system in New England.

Manager, Control Center NY, monitors, controls, and operates National Grid's transmission system in New York State.

Manager Operational Planning and Review, responsible for outage scheduling, performance monitoring, benchmarking, and post event review.

Outage Coordinator, Control Center NY, coordinates & schedules short term transmission outages while maintaining system security.

Principal Training Representative, Control Center NE, develops and delivers training programs and simulator scenarios for operators and support personnel in New England and New York.

Senior Engineer, Control Center NY, perform system studies, maintain EMS security software, provide control room technical support, contribute to development & review of operating criteria & policies, and provide input to the NYISO on the resolution of operating problems.

Shift Supervisor, Control Center NY, responsible for system security, authorization of outages, & over-all operation of the New York transmission system. Directs response to system emergencies.

Supervisor Transmission and Security Dispatch, Control Center NE, responsible for day-to-day operation of the New England control room - including schedules, personnel, and technical issues.

Supervisor Transmission and Security Dispatch, Control Center NY, responsible for day-to-day operation of the New York control room - including schedules, personnel, and technical issues.

System Control Center Operator, Control Center NE, monitors, assesses and responds to all alarms. Responsible for all switching and tagging functions & coordination with field personnel.

System Control Center Operator, Control Center NY, is liaison between NYISO & generators, notifies generators of reserve pick-up requirements, ensures that generators are at their base points, tracks generator de-rates, schedules through the ISO, out of merit generation, and verifies/corrects generator schedules as necessary.

System Operator – Security, Control Center NE, responsible for system security, authorization of outages, and overall operation of the New England transmission system. Also, responsible for REMVEC Satellite system security. Directs response to system emergencies.

NATIONAL GRID USA

Director Internal Audit, has primary responsibility for the designs and implements a comprehensive internal audit program, conducting risk assessments, and preparing audit plans, policies, and procedures.

National Grid USA President & CEO, has primary responsibility for the profitability and growth of National Grid in the US. Directs the corporation in establishing long-range plans, strategy and policy with the Board of Directors.

SVP and CFO, directs the overall financial plans and accounting practices of organization. Oversees treasury, accounting, budget, tax and audit activities of the organization and subsidiaries. Oversees financial and accounting system controls and standards and ensures timely financial and statistical reports for management and/or Board use.

SVP and General Counsel Legal Services & External Relations, serves as chief legal adviser, counsels management on legal implications of company activities and issues and provides legal services as required in judicial proceedings. Oversees corporation communications activities including the development of programs and policies for internal and external communications.

SVP Human Resources, plans and directs programs for all human resources areas including employee relations, labor relations, compensation, training and development, benefits administration and equal employment opportunity. Develops policies and programs to meet organizational needs and provides guidance and technical assistance to other areas.

CHIEF OPERATING OFFICER

SVP and President Distribution Companies NE, has primary responsibility for the overall profitability and management of the regulated utility business unit in New England. This position is responsible for the operations of the electric distribution system of the business unit, customer service, management of commercial, industrial and municipal key accounts, marketing of customer programs and community/regulatory relations for the service territory.

SVP NG and President Niagara Mohawk, has primary responsibility for the overall profitability and management of the regulated utility business unit in New York and is responsible for the operations of the electric and gas distribution system of the business unit, customer service, management of commercial, industrial and municipal key accounts, marketing of customer programs and community/regulatory relations for the service territory.

SVP Information Technology, has primary responsibility for the strategic direction of the company's information technology resources; contributes to general business planning regarding technology and systems required to maintain company operations and competitiveness. Establishes long-term needs for information systems, and plans strategy for developing systems and acquiring hardware to meet application needs.

SVP T&D Technical Services, has responsibility for the engineering and technical requirements of the electric delivery system; operations and maintenance of the company's facilities; development of policies and procedures for procurement and control of materials, supplies, equipment and services; environmental policies and programs that comply with regulations; development of technical training programs; and, fleet management.

NEW ENGLAND DISTRIBUTION

EVP Business Services & Public Affairs Granite State Electric & VP Business Services Merrimack Valley, responsible for regulatory and legislative matters as well as Business Services. Oversees all regulatory filings, appears as policy and overview witness in some proceedings, testifies before legislative committees and coordinates and develops activities and strategies of outside lobbying firm.

EVP Business Services & Public Affairs Narragansett Electric Company, responsible for regulatory and legislative matters as well as Business Services. Oversees all regulatory filings, appears as policy and overview witness in some proceedings, testifies before legislative committees and coordinates and develops activities and strategies of outside lobbying firm.

SVP Business and Retail Services, responsible for building and maintaining strong relationships with all non-residential customers in New England. Responsible for effective design and implementation of all energy efficiency programs to residential and non-residential customers in New England.

SVP Customer Service, responsible for all call center activities, credit and collections, billing, revenue protection, metering services and customer satisfaction.

SVP Distribution Finance, has primary responsibility for financial analysis, planning and budgeting in support of the retail distribution business unit in New England, as well as overseeing the management of the electric commodity procurement program for customers taking last resort service.

SVP Operations, responsible for Operations, Engineering, Dispatch, Construction and Maintenance Services, and Relay and Telecommunications for Massachusetts Electric Company, The Narragansett Electric Company, Granite State Electric Company and Nantucket Electric Company.

VP and Director Public Affairs, coordinates Massachusetts Electric's legislative and public policy initiatives. Serves as Massachusetts Electric's liaison to trade associations in Massachusetts.

VP Safety NE & NY, responsible for the area safety and health planning and performance monitoring and initiation of necessary actions. Provides oversight and plans to maintain compliance with regulatory requirements and internal requirements. Provides for safety and health training programs development and delivery.

BUSINESS AND RETAIL SERVICES NEW ENGLAND

Account Manager, responsible for marketing and sales of energy products and services to C&I customers; including electrical service installation, demand side management technical assistance, economic development, power quality, cogeneration analysis and eligible rate options.

Business Specialist (this includes Senior and Principal Business Specialist), will provide team oriented account management and support for all commercial and industrial and on-active municipal accounts that are not part of the key accounts management group.

Energy Efficiency Consultant (this includes Principal Energy Efficiency Consultant), will manage the BSO's DSM effort, including coordinating the Project Expeditors, vendors and assist with technical consultants.

Key Account Manager, responsible for managing assigned strategic commercial, industrial and municipal customers in a large geographic territory.

Technical Representative, Senior Technical Representative, Principal Technical Representative, Senior Technical Support Representative and Principal Technical Support Representative, provides support for demand side management programs by assessing energy efficiency opportunities within business customers' facilities.

VP Business Services, overall responsibility for providing all services and programs to Massachusetts Electric Company business customers including hookup of electrical services and demand side management programs.

BUSINESS SERVICES AND PUBLIC AFFAIRS NARRAGASET ELECTRIC COMPANY

Account Manager, responsible for marketing and sales of energy products and services to C&I customers; including electrical service installation, demand side management technical assistance, economic development, power quality, cogeneration analysis and eligible rate options.

Account Representative (this includes Senior Account Representative), coordinates new electric services and service upgrades for small to medium size commercial and industrial customers, residential developments and municipal customers, including providing information on the company's energy conservation programs.

Senior Technical Support Representative, provide technical support to implement commercial and industrial energy efficiency services. Work directly with account managers to identify and evaluate energy efficiency opportunities in customer's facilities.

VP Business Services, overall responsibility for providing all services and programs to Narragansett Electric Company business customers including hookup of electrical services and demand side management programs.

BUSINESS SERVICES AND PUBLIC AFFAIRS GRANITE STATE

EVP Business Services and Public Affairs, responsible for regulatory and legislative matters as well as Business Services. Oversees all regulatory filings, appears as policy and overview witness in some proceedings, testifies before legislative committees and coordinates and develops activities and strategies of outside lobbying firm.

Key Account Manager, responsible for managing assigned strategic commercial, industrial and municipal customers in a large geographic territory.

NEW ENGLAND DISTRIBUTION OPERATIONS

Director Dispatch & Control, provides director level oversight to the Substation-Subtransmission control center in Westboro MA, the Distribution Dispatch Control center in Lincoln Rhode Island and the Distribution trouble center. These organizations, monitor, direct switching activities and dispatch field resources as necessary to assure reliable service to the <69KV National Grid USA (New England) electrical network.

Manager Relay & Telecommunications, set strategic directions for the National Grid companies in the areas of system protection, control and telecommunication, which includes innovative approaches to the administration of personnel issues and the implementation of technological advances that will better position the National Grid companies for the future.

VP Electric Distribution Planning & Engineering, designs electric and gas distribution and electric sub-transmission facilities in a cost-effective manner to insure a maximization of EVA and shareholder values while satisfying customer, governmental and third party expectations.

VP Operations, (this function reports to the SVP Operations for both New England and New York), responsible for the management of structural contracted services for all of National Grid USA including Transmission, Substations, distribution, Gas and Forestry.

VP Operations Performance Improvement (this function reports to the SVP Operations for both New England and New York), will direct a multi-disciplinary team that will analyze work processes, methods and technologies used by the electric and gas operating groups of NG in the US to develop and identify changes that will improve the efficiency of the operating groups.

NEW ENGLAND AND NEW YORK CONSTRUCTION AND MAINTENANCE SERVICES

Analyst, Planning and Scheduling (this includes Principal Analyst), develop, implement and maintain strategic planning schedule for all work being performed by outside contractors and internal CM&S crews. Coordinate short-term schedule(s) with the strategic planning schedule.

Analyst, Substation Construction Services (this includes Senior Analyst), organize, analyze, track, compare and/or present data. Conduct special project assignments.

Arborist (this includes Senior Arborist and System Arborist), plan, budget and implement the vegetation management program; develop long- and short-term plans; analyze data and conduct field surveys, use of an activity based budget and implement and administer plans within the budget.

Associate Analyst, CAS Construction Contracts, supports the day-to-day administrative duties of the department.

Construction Coordinator, CAS Construction Contracts, field construction coordinator handling electric distribution contractors in New England.

Construction Coordinator, Gas Contract Services, field construction coordinator that oversees the activities of the outside gas contractors in New York.

Contracts Coordinator, CAS Construction Contracts, field construction coordinator oversees civil contractors.

Coordinator Overhead Lines, Transmission Line Services, coordinate, and expedite the various construction and maintenance programs on the transmission system.

Coordinator, Distribution Contract Services, responsible for overseeing master service agreements to do distribution design.

Director Contract Management, responsible for the development, implementation and monitoring of vendor contracts, compliance with fiscal requirements in addition to planning the work schedules to meet business plan objectives. Develop the appropriate contractor procurement strategy and model for various construction activities and projects.

Director, Substation Construction Services, plan, organize, control and direct the operations & management of Civil and Electrical in-house and contracted substation work forces. Responsible for achieving of project milestones and schedules.

Director, Transmission Line Services, responsible for all electrical construction and maintenance activities on the transmission system.

Lead Senior Engineer, Quality Field Contracts, overall coordinator and planner for the Field Construction Coordinators.

Lead Supervisor, Electrical Construction Services, plan, coordinate and supervise electrical substation construction work. Assign personnel and equipment to crews to ensure progress. Provide liaison between Engineering and Field Supervision from the development of project estimates through final acceptance of work.

Manager Distribution Contract Services, assure the design and implementation of a strategic contract labor initiative that produces 100% compliance with safety, construction and budgetary requirements. Oversee the development and maintenance of the Contractor Performance database.

Manager Distribution Forestry, responsible for developing, implementing and overseeing an effective company vegetation management program within related safety, budget, customer satisfaction and reliability targets. Supervise Arborists throughout the NY/NE service territory responding to the needs of both the Transmission and Distribution organizations.

Manager Field Accounting, CAS Administrative Services, ensure group compliance with applicable safety and environmental standards, guidelines and regulations. Design and implement a sound field accounting approach that captures all labor indices required to develop a contract model analytical tool.

NEW ENGLAND AND NEW YORK CONSTRUCTION AND MAINTENANCE SERVICES

Manager Planning and Scheduling, design and implement planning/scheduling strategies and programs that produce 100% compliance with safety, construction, budgetary and value creation requirements. Manage, balance and coordinate resources to optimize progress on short term reactive and long term strategic initiatives.

Manager Quality/Field Contracts, design and implement a project management program that produces 100% compliance with safety, construction and budgetary requirements. Provide construction performance and budgetary updates as required.

Manager Quality/Gas Contracts, Gas Contract Services, manages internal and external group of Field Construction Coordinators that oversee the day to day activities of outside contractors in New York.

Operations Planner, Substation Construction Services, work with others in the department to ensure that training, tracking and reporting requirements are fully met.; work with others in the department to administer safety program and bargaining unit contract. Represent the department on special inter-department projects, prepare reports and conduct analyses as requested by the Department Director and the VP of Construction & Maintenance Services.

Operations Planner, CAS Administrative Services, provides support to day-to-day substation activities.

Operations Planner, C&M Services, Management, responsible for the management of all performance programs for structural contracted services for all of National Grid USA including Transmission, Substations, Distribution, Gas and Forestry.

Scheduler, Transmission Line Services, perform daily scheduling of the various construction and maintenance programs on the transmission system.

Senior Engineer Field, Distribution Contract Services, supports the development of a strategic contract labor initiative that produces 100% compliance with safety, construction, and budgetary requirements in both New England and New York. Develop strategic alliances with multiple vendors to support these initiatives by leveraging new technologies, applications, and work practices.

Superintendent, Transmission Line Services, perform all duties associated with the management of the supervisory workforce.

Supervisor, CAS Administrative Services, supervises field accounting staff.

Supervisor, CAS Construction Contracts, supervises Field Construction Coordinators overseeing outside contractors construction activities.

Supervisor, Depot, plan, coordinate and supervise transportation, hauling and hoisting & rigging work required to support Substation and Transmission work. Assign personnel and equipment to crews to ensure progress. Provide liaison between Engineering and Field Supervision from the development of project estimates through final acceptance of work.

Supervisor, Electrical Construction Services, plan for and direct activities of crews and individuals assigned to electrical substation or civil construction sites. Administer bargaining unit agreement, prepare and process required reports on job/project progress and assist Lead Supervisor in developing estimates.

Supervisor, Small Structural Services, plan, coordinate and electrical supervise civil construction work. Assign personnel and equipment to crews to ensure progress. Provide liaison between Engineering and Field Supervision from the development of project estimates through final acceptance of work.

NEW ENGLAND DISTRIBUTION DISPATCH AND CONTROL

Chief Division Dispatcher, participates in special projects that relate to the Distribution Dispatch Centralization Project.

Coordinator System Control Center, provides work application coordination to the Substation- Sub transmission control center at Westboro MA. This organization, monitors, direct switching activities and dispatches field resources as necessary to assure reliable service to the <69KV sub transmission and substations within the NG USA (New England) electrical network.

Coordinator System Control Center, provides work application coordination to the Distribution control center at Lincoln, RI. This organization, monitors, direct switching activities and dispatches field resources as necessary to assure reliable service to the distribution system within the NG USA (New England) electrical network.

Designer (this includes Senior Designer), responsible for creating, maintaining and updating operating maps utilized by distribution control centers (Lincoln and Westboro).

Lead Supervisor, Trouble Center, provide technical assistance, guidance, support, communicate with districts, coordinate power restoration, answer inquiries for external and internal customers; solve district concerns and track all abnormal weather conditions.

Manager Distribution Disptach, provides manager level oversight to the control center. This organization, monitors, direct switching activities and dispatches field resources as necessary to assure reliable service to the Distribution systems within the southern divisions of NG USA (New England) electrical network.

Manager Distribution Dispatch Projects, provides project leadership in an initiative to consolidate Substation-Subtransmission control, Distribution Dispatch and the Distribution trouble centers in New England. These organizations, monitor, direct switching activities and dispatch field resources as necessary to assure reliable service to the <69KV NG USA (New England) electrical network and efforts are underway to organize on a geographic basis rather than the current functional model.

Manager Substation & Subtransmission Dispatch, provides manager level oversight to the Substation-Subtransmission control center in Westboro MA. This organization, monitors, direct switching activities and dispatches field resources as necessary to assure reliable service to the <69KV subtransmission and substations within the NG USA (New England) electrical network.

Principal Training Representative, train, develop, mentor and coach new control center operators from initial entry into the department through their becoming fully rated transmission and security system operators. Perform periodic refresher training for fully rated operators to maintain and improve skills as well as to incorporate new systems and procedures.

Shift Supervisor Control Room, provide supervision/leadership of daily shift operations of the Dispatch & Control organization.

Superintendent Distribution Dispatch and Control NE, provides supervisor level oversight to the Distribution Control Center at Lincoln, RI. This organization monitors and directs switching activities and dispatches field resources as necessary to assure reliable service to the distribution system within the NG USA (New England) electrical network.

Superintendent Distribution Dispatch and Control NE, provides supervisor level oversight to the Substation- Sub transmission control center at Westboro MA. This organization, monitors, direct switching activities and dispatches field resources as necessary to assure reliable service to the <69KV sub transmission and substations within the NG USA (New England) electrical network.

System Control Center Operators, Distribution Dispatch and Control NE, Westborough, MA, monitors and directs switching for the safe and reliable operation of the substations and sub-transmission system within the NG (New England) electrical network.

System Control Center Operators, Distribution Dispatch and Control NE, Lincoln, RI, monitors and directs switching for the safe and reliable operation of the distribution system within NG (New England) electrical network.

NEW ENGLAND DISTRIBUTION DISPATCH AND CONTROL

Trouble Center Operator (this includes Assistant Trouble Center Operator), directs outage management, reads system maps, uses radios, controls field crews, maintains documents, uses call system, assists customer service, provides updates to all internal customers and performs duties as assigned.

NEW ENGLAND DISTRIBUTION ELECTRIC DISTRIBUTION PLANNING AND ENGINEERING

Coordinator, responsible for regular interaction with various state Departments of Transportation to secure annual permits for construction activities in and around state highways, secure as needed permits for specific distribution infrastructure development projects and coordinate the processes associated with “force account” projects.

Engineer, Distribution Planning and Engineering (this includes Associate, Senior, Lead Senior and Principal Engineer), conducts short and long range feeder management studies and recommend system facilities changes to provide economic and reliable electricity delivery for customers of National Grid USA Retail Companies.

Engineer, System Planning & Engineering (this includes Lead Senior Engineer), oversee the use of IT systems to ensure consistency across all National Grid USA Divisions. Prepare annual and or ad hoc regulatory reports. Lead and coordinate annual system performance assessments and application of “new technologies” on distribution and distributions supply systems.

Engineering Planner, Distribution Planning and Engineering, conducts short and long range area feeder management studies and recommends system facilities changes to provide economic and reliable electricity delivery for customers of National Grid USA Retail Companies.

Engineering Planner, System Planning & Engineering, oversee the use of IT systems to ensure consistency across all National Grid USA Divisions. Prepare annual and or ad hoc regulatory reports. Lead and coordinate annual system performance assessments and application of “new technologies” on distribution and distributions supply systems.

Manager Distribution Planning & Engineering, manage the staff and operations towards the goal of improving the asset health of the electric delivery system, considering safety, reliability, and customer satisfaction. Communicate planning policies and standards, manage feeder analysis, develop system capital project priorities and support planning activities system-wide.

Manager System Planning & Engineering, leads and coordinates the development and/or purchase of IT systems used by planning engineers to facilitate, prioritize and document their work efforts. Leads and coordinates the ongoing review and development of planning criteria and feeder management guidelines. Provides guidance, real time training and technical assistance to other departments in the area of asset management.

Principal Financial Analyst, participate in the development and maintenance of annual work plans and five year spending plans. Analyze, identify, and explain actual-to-budget variances as well as report on key performance drivers. Support the continuous management of the Distribution Resource Allocation Committee work plans by monitoring, measuring performance, reporting, and forecasting on a continual basis throughout the fiscal year.

CUSTOMER SERVICE

Coach/Supervisor Customer Service, Accounts Processing, the principal accountability of this position is to plan, organize, coach and maintain self-directed work teams engaged in all aspects of customer contact with the goal of providing excellent customer service that will achieve superior customer satisfaction results.

Coach/Supervisor Customer Service, Call Center Buffalo, plans, organizes, coaches and maintains work teams engaged in all aspects of customer contact with the goal of providing excellent customer service that will achieve superior customer satisfaction results.

Coach/Supervisor Customer Service, Call Center Syracuse, plans, organizes, coaches and maintains work teams engaged in all aspects of customer contact with the goal of providing excellent customer service that will achieve superior customer satisfaction results.

Director Customer Service NE, directs and oversees the management of the call center, accounts processing, training and small business group within the call center organization.

Director Customer Service NY, directs and oversees the management of the call center, accounts processing, training and small business group within the call center organization.

Manager Accounts Processing NY, accountable for planning, directing and maintaining responsive, cost effective billing support activities for customer service operations. Administers reactive and proactive telephone and written communications with customers relating to service, complaints, billing exceptions, payments, accounting problems and general information to ensure conformity with Company policies and procedures.

Manager C&I Business Team, provide overall management of the Small Business Customer Group including determining and maintaining appropriate staffing levels, development of professional staff and ensuring that the SBCG functions efficiently and in a cost effective manner.

Manager Call Center Buffalo, the position is accountable for planning, directing, and maintaining responsive, cost-effective customer service telephone operations. Administers reactive and proactive telephone communications with customers relating to service, complaints, billing, payments, accounting problems, and general information to ensure conformity with Company policies and procedures.

Manager Call Center Syracuse, provides overall management of the call center which includes determining and maintaining appropriate staffing levels; development of the professional staff; ensuring that the center functions efficiently and in a cost effective way; defines and implements new processes; maintains an effective working relationship with the union leadership.

Manager Customer Satisfaction & Strategic Planning, directs, plans and organizes the work activities of the E-business, Customer Communication & Change Management and Customer Relationship management functions in Customer Service. Directs project management team's activities in support of Customer Service organization to insure timely and effective implementation of assigned initiatives. Performs projects assigned by SVPs of Customer Service as assigned.

Senior Analyst, Call Center Syracuse, provides analytical support to assist in the meeting of service quality goals. Find opportunities for efficiency improvements and cost savings for the call center and account processing.

Team Coordinator, Call Center Buffalo, the primary role of this position is to plan, direct, organize, and coordinate Team Leader and Senior Representative activities in order to maximize performance and productivity.

Team Coordinator, Call Center Syracuse, the primary role of this position is to plan, direct, organize, and coordinate Team Leader and Senior Representative activities in order to maximize performance and productivity.

NEW ENGLAND DISTRIBUTION FINANCE

Analyst, Budgeting and Reporting (this includes Senior, Senior Financial and Principal Analyst and Financial Analyst), prepares, analyzes and justifies distribution capital and operations & maintenance budgets based on employment levels, forecasted work load and scheduling, estimated expenses, historical data, and trends.

Analyst, Energy Supply NE, supports and assists as required in the administration and procurement of power supplies to fulfill National Grid's provider of last resort service obligations and the completion of the divestiture of New England Power Company's residual generation interests.

Coordinator, Energy Supply NE, supports and assists as required in (1) the administration and procurement of power supplies to fulfill National Grid's provider of last resort service obligations, (2) the completion of the divestiture of New England Power Company's residual generation interests, and (3) the representation of National Grid on various committees in the New England Power Pool.

Director Planning & Financial Analysis, manages economic and financial analysis and guidance in determining the economic and financial viability of various projects being performed and business ventures being initiated within the Distribution Business.

Manager, Distribution Finance Budgeting and Reporting, leads and coordinates financial analysis activities including identification, formulation and analysis of strategies or proposals. Initiates and leads the financial analysis of various projects, proposals and studies. Provides guidance, real time training and technical assistance to other departments in the area of financial analysis. Leads the analysis of core and non-core pricing policies.

Manager, Energy Arrangements, provides management support to the VP Energy Supply New England in (1) the administration and procurement of power supplies to fulfill National Grid's provider of last resort service obligations, (2) the completion of the divestiture of New England Power Company's residual generation interests, and (3) the representation of National Grid on various committees in the New England Power Pool.

Principal Analyst, Energy Supply NE, supports and assists as required in (1) the administration and procurement of power supplies to fulfill National Grid's provider of last resort service obligations, (2) the completion of the divestiture of New England Power Company's residual generation interests, and (3) the representation of National Grid on various committees in the New England Power Pool.

Principal Analyst, Planning & Financial Analysis, (this includes Senior and Principal Financial Analyst) support and facilitate the development and establishment of spending plans. Monitor, measure performance, report, and forecast on a continual basis throughout the fiscal year.

VP Energy Supply NE, directs the procurement of the power supply portfolio required to fulfill the provider of last resort service obligations of the National Grid distribution companies to their retail customers; directs the completion of the divestiture of New England Power Company's residual generation interests; represents National Grid on various committees in the New England Power Pool.

NEW YORK DISTRIBUTION

Assistant to President Distribution Company NY, serve as key point of contact for senior level management. Assist the President in the research and resolution of problems that may arise; assess and recommend various strategic courses of action; assume responsibility for special projects as assigned.

SVP Business Development, responsible for building and maintaining strong relationships with non-residential customers in Niagara Mohawk's service territory. Responsible for effective design and implementation of economic development programs designed to attract and retain commercial and industrial customers in Niagara Mohawk's service territory.

SVP Distribution Finance, responsible for providing strategic direction and oversight of electric and gas pricing, financial regulatory matters and budget and financial analysis.

SVP Customer Service NY, responsible for all center activities, credit and collections, billing, revenue protection, metering services and customer satisfaction.

SVP NY Operations, responsible for gas and electric operations, engineering, dispatch, construction and maintenance for Niagara Mohawk.

BUSINESS SERVICES AND ECONOMIC DEVELOPMENT

Account Manager, cultivates and enhances effective customer relationships; calls proactively on major industrial, municipal and commercial customers via a targeted account management philosophy.

Account Representative (this includes Senior Account Representative), coordinates new electric services and service upgrades for small to medium size commercial and industrial customers, residential developments and municipal customers, including providing information on the company's energy conservation programs.

Analyst and Senior Analyst, Program and Policy Administration, provides analytical and administrative support for the Business Services and Economic Development organization, including the strategic account management, economic development and consumer relations functions.

Analyst, Outdoor Lighting, develops, implements and maintains reporting, tracking and status of data management that supports the Outdoor Lighting market segment. Gathers, interprets, analyzes and recommends technical and administrative solutions relating to the daily operation and maintenance of individual applications within the Outdoor Lighting business.

Consumer Representative, represents the Company in negotiations with all customers regarding the sale of additional use of electric and gas service, advises customers in the proper application of their electric and gas service and calls on customers to determine applicable rates, coding, accuracy of meter readings and explain customers' bills. Additionally maintains sales contacts with dealer outlets, builders, electrical and gas trade, and allied organizations.

Director Outdoor Lighting, plan, direct and coordinate outdoor lighting activities system-wide to ensure results support business goals. Coordinate all aspects of National Grid's outdoor lighting business including sales, marketing, pricing, construction, operation, maintenance, service and inspection to ensure the value of the Corporation's assets are maximized.

Director Program & Policy, manages the support organization for the Business Services and Economic Development (BSED) that includes the strategic account management, economic development and consumer relations functions. Responsible for all administrative, regulatory and policy work associated with the Company's Empire Zone Rider (EZR) discount program

Economic Development Representative (this includes Senior and Principal Economic Development Representative), conducts marketing and sales efforts to attract new businesses to Niagara Mohawk's service territory. Works with local communities to prepare marketing plans and fully serviced sites and provides technical expertise and interface with site selectors and corporate realtors.

VP Business Services, direct, plan, schedule, budget and coordinate all aspects of electric and gas construction, operation and maintenance to ensure the value of the Corporation's assets are maximized and protected. Responsible for regional asset profitability, reliability, asset condition and regional customer satisfaction. Lead company contact with community, political, and business leaders in the region served.

VP Economic & Community Development, develops and manages the corporation's strategy to attract new jobs and capital investment to the service territory. Responsible for implementation of the economic development plan programs contained in the merger rate agreement and managing the regulatory, political and business relationships associated with that effort.

NEW YORK DISTRIBUTION DISPATCH AND CONTROL

Communications Tester, installs, tests and maintains the most complicated data collection, communications systems including carrier and microwave where associated with bulk power system; supervisory control, tone equipment and associated equipment where concerned with data collection and communications only; and to prepare reports requiring conclusions or recommendations relating to the job duties.

Chief Service Dispatcher, under general supervision, to work with, train and direct Service Dispatchers; to be responsible for planning, assigning, and recording of work orders; to perform responsible work.

Director Dispatch & Control, provides director level oversight for the Regional Dispatch and Control Centers in NY. These organizations monitor, direct switching activities, dispatch field resources, provide real-time operation, and provide EMS RTU and control center technical support, for the National Grid USA (New York) transmission and distribution network.

Manager Distribution Dispatch NY, provides manager level oversight for System Operations Dispatch in Syracuse, NY. This organization provides the dispatch function primarily for the NY Service Department, and also provides the interface with public emergency agencies such as fire and police departments, supporting both the gas and electric businesses.

Manager Distribution Dispatch Project, provides guidance and direction to the staff of the three NY Regional Control Centers and the System Dispatch group in the planning and implementation of various projects involving new technologies and processes directed toward the ongoing efficiency of these operations.

Manager Gas Energy Management Systems, accountable for managing in a cost effective manner the operation of the Gas Energy Management System to ensure long term gas system operational integrity and support economic gas dispatching during normal and emergency conditions.

Manager Regional Control Western, provides manager level oversight for the Western Regional Control Center (WRCC) in Buffalo, NY. This organization monitors, directs switching activities and dispatches field resources as necessary to assure reliable service to the transmission and distribution systems serving the Frontier and Western Regions of New York.

Manager Regional Control Center Central, provides manager level oversight for the Central Regional Control Center (CRCC) in Syracuse, NY. This organization monitors, directs switching activities and dispatches field resources as necessary to assure reliable service to the transmission and distribution systems serving the Central, Northern and Mohawk Valley Regions of New York.

Manager Regional Control East, provides manager level oversight for the Eastern Regional Control Center (ERCC), in Guilderland, NY. This organization monitors, directs switching activities, and dispatches field resources as necessary to assure reliable service to the transmission and distribution systems serving the Capital and Northeastern Regions of NY.

Regional Operator, under the general supervision to control, direct and monitor electric substations, hydro-generating stations, transmission networks and distribution facilities within a Regional Control Center's jurisdiction including making load, voltage and reactive adjustments using state of the art equipment.

Relief Operator, under general supervision to control, direct and monitor electric substations, hydro-generating stations, transmission networks and distribution facilities within a Regional Control Center's jurisdiction including making load, voltage and reactive adjustments using state of the art equipment.

Service Dispatcher, under general supervision on a shift or schedule in a combination gas and electric area, in the Service Department, to analyze all calls and to assign or reassign Service Representatives, line crews or gas operating crews under emergency or routine conditions.

Shift Supervisor Control Room, responsible for all activities on a shift, including supervision of represented personnel, for the region. This organization monitors, directs switching activities, and dispatches field resources as necessary to assure reliable service to the transmission and distribution systems.

NEW YORK DISTRIBUTION DISPATCH AND CONTROL

Superintendent Regional Control, Central, provides superintendent level oversight for the Central Regional Control Center (CRCC) in Syracuse, NY. This organization monitors, directs switching activities, and dispatches field resources as necessary to assure reliable service to the transmission and distribution systems serving the Central, Northern and Mohawk Valley Regions of NY.

Superintendent Regional Control, Western, provides superintendent level oversight for the Western Regional Control Center (WRCC) in Buffalo, NY. This organization monitors, directs switching activities, and dispatches field resources as necessary to assure reliable service to the transmission and distribution systems serving the Frontier and Western Regions of NY.

Supervisor, responsible for all activities on a shift, including supervision of represented personnel, for the region. This organization monitors, directs switching activities, and dispatches field resources as necessary to assure reliable service to the transmission and distribution systems.

Senior Gas Operations Specialist, responsible to develop, issue, revise, coordinate and implement gas operating procedures, standards, policies, practices and programs.

Supervisor Gas Control, accountable for supervising the work of personnel engaged in monitoring, controlling and data acquisition of the gas pipeline system to ensure system integrity and operational efficiency to provide reliable and safe gas service.

System Gas Control Operator B, provide direction as required to accomplish duties such as to identify and analyze emergency situations including the notification of personnel as required to monitor security and other alarms for stations and other Company facilities.

Trouble Dispatcher, under general supervision, coordinates all activities essential to maintaining uninterrupted electrical service to customers on our distribution system through the development and dispatching or execution of switching procedures for various reasons, i.e., load transfer or cable repairs.

NEW YORK DISTRIBUTION ELECTRIC DISTRIBUTION PLANNING AND ENGINEERING

Analyst, Gas Operations Support, responsible for performing a variety of routine technical work requiring the application of standard techniques, methods, procedures, practices, policies, programs and cost analysis in carrying out a sequence of related technical tasks. The position exists to ensure compliance with Company, federal and state requirements.

Designer, Distribution Planning & Engineering, under general supervision, develops complete designs for construction projects of all types, prepares studies, reports, specifications and estimates, prepares study drawings to determine the best arrangement of major items of electrical and mechanical equipment, and prepares specifications for construction and materials.

Designer, System Planning & Engineering, under general supervision, develops complete designs for construction projects of all types, prepares studies, reports, specifications and estimates, prepares study drawings to determine the best arrangement of major items of electrical and mechanical equipment, and prepares specifications for construction and materials.

Director Gas Assets & QA, responsible for the development and implementation of the annual and 5 year gas work plan, specifically selecting, funding and insuring the construction of approximately \$50 million of capital improvements that will best enhance the gas system optimizing safety, reliability and shareholder value.

Drafting Technician, System Planning & Engineering, under direct supervision, to do good tracing and complex detailing involving no original design of plans and drawings for construction projects of all types and of diagrams, maps, and records. Performs other related duties such as assisting in recording on maps and records, additions and retirements of gas facilities and overhead and underground electric transmission and distribution facilities and assists in taking field measurements and physical inventories.

Electric Planner, Distribution Planning & Engineering, under general supervision, translates general plans into detailed construction orders, prepares complicated layouts of overhead or underground distribution and transmission facilities and prepares cost estimates of construction and maintenance projects.

Engineer, Distribution Planning & Engineering (this includes Associate, Senior, Lead Senior and Principal Engineer), responsible for engineering planning and prioritization of capital resource decisions, reliability analysis for the electric distribution facilities and engineering planning services are provided to the transmission business unit for transmission substations generally with a low side voltage of 13.2kV and lower. Additionally, provide electrical interconnection policies and procedures.

Engineer, System Planning & Engineering (this includes Associate, Senior, Lead Senior and Principal Engineer), responsible for engineering planning and prioritization of capital resource decisions, reliability for the electric sub-transmission facilities (generally > 15kV up to and including 69Kv) and engineering planning services are provided to the Transmission Business Unit for transmission substations generally with a sub-transmission low side voltage.

Manager Distribution Planning & Engineering (Western, Central and Eastern), manage the staff and operations of the Distribution Planning & Engineering department towards the goal of improving the asset health of the electric delivery system, considering safety, reliability, and customer satisfaction. Develop, maintain, and communicate planning policies and standards, manage feeder analysis and area planning schedules, develop system planning and capital project priorities, and support planning activities system-wide.

Manager Gas Operations Support, plans, directs, organizes and coordinates the activities of the Gas Operations Support, Gas Meter Shop and Gas Metering Program including the development and implementation of operating procedures, practices and policies to assure compliance with local, state and federal regulations.

Manager System Planning & Engineering NY, leads and coordinates engineering planning activities including identification, formulation and technical and financial analysis of strategies or proposals. Provides guidance, real time training and technical assistance to other departments in the area of asset management.

Principal Gas Operations Specialist, Gas Assets & QA, responsible to develop, issue, revise, coordinate and implement gas operating procedures, standards, policies, practices and programs.

Senior Gas Operations Specialist, Gas Assets & QA, responsible to develop, issue, revise, coordinate and implement gas operating procedures, standards, policies, practices and programs.

NEW YORK DISTRIBUTION ELECTRIC DISTRIBUTION PLANNING AND ENGINEERING

Senior Gas Operations Specialist, Gas Operations Support, responsible to develop, issue, revise, coordinate and implement gas operating procedures, standards, policies, practices and programs.

VP Electric Distribution Planning & Engineering, design electric and gas distribution and electric sub-transmission facilities in a cost-effective manner to insure a maximization of EVA and shareholder values while satisfying customer, governmental and third party expectations.

NEW YORK CUSTOMER SERVICE

Analyst, Billing and Systems, organize, analyze, track, compare and/or present data. Conduct special project assignments. Process requisitions and invoices timely and accurately through PMP system.

Analyst, C&I Collections (this includes Senior and Principal Analyst), analyzes, recommends and implements policy, process and system enhancements to improve collections performance. Reviews, reports on, and manages day-to-day collection operational activities. Carries out large customer collection activities involving specialized negotiation, litigation or field treatment.

Analyst, New Requests/Operational Compliance (this includes Senior Analyst), analyzes, recommends, and implements solutions to customer billing, finance, and service issues. These issues can be corrective in nature, or offer significant improvement in efficiency and/or accuracy. Provide research and analytical support of customer information to the business units in support of their departmental and corporate goals. Assure proper operations of all customer-related systems.

Analyst, Supplier Services (this includes Senior Analyst), analyze, recommend, and implement solutions to competitive supply issues. These issues can be corrective in nature, or offer significant improvement in efficiency and/or accuracy. Provide research and analytical support of customer information to the business units in support of their departmental and corporate goals. Assure proper operations of all supplier services functions. Manage relationships with competitive providers and governing bodies such as the NY Public Service Commission.

Coach/Supervisor Customer Service, Call Center, plans, organizes, coaches and maintains work teams engaged in all aspects of customer contact with the goal of providing excellent customer service that will achieve superior customer satisfaction results.

Coach/Supervisor Customer Service, Billing and Systems, oversees and organizes work activities of analysts performing manual billing activities. These activities involve collecting billing determinants, producing and mailing customer invoices, posting revenue to the corporate general ledger, and all other reporting activities that are necessary following customer billing. The coach is also a process director and agent for improved effectiveness and efficiency in the manual billing process. He/she also maintains close relationships with Accounts Processing to assure coordinated activities.

Collection Service Associate, Administration and Consumer Advocacy (this includes Senior and Chief Collection Service Associate), performs and accepts incoming and outgoing-related calls, resolves disputes and negotiates payment terms in an assertive and professional fashion, provides financial direction for customer and/or makes appropriate referral, processes customer-related transactions, documents and communications and interfaces with third parties.

Consumer Advocate, Administration and Consumer Advocacy, creates increased awareness of, and protects public health and safety related to the provision of electric and gas service. Assist low income and special needs customers to meet their energy needs through energy efficiency programs, outreach and education.

Director, Credit and Collections, plans and directs the financial and operational performance of collection functions, directs the management of collection activities to significantly reduce outstanding arrears and uncollectible accounts to acceptable industry levels.

Manager Administration and Consumer Advocacy, manages collections back office activities including transaction with county social service agencies, collection agency administration, and collections call center support. Provides the policy, centralized strategy and general direction for activities provided by Consumer Advocates within the Niagara Mohawk service territory.

Manager Billing and Systems NY, directs, plans and organizes the work activities of support staff focused on resolving issues related to the Customer Service System (CSS), increasing system efficiency, reducing costs and improving customer satisfaction. Directs the evaluation and prioritization of CSS issues identified from all user departments and ensures the allocation of appropriate resources to resolve and implement necessary changes.

NEW YORK CUSTOMER SERVICE

Manager Low Income Customer Assistance NY, plans and manages a staff responsible for the implementation of the Company's low income program. The program includes an affordable payment agreement offer, energy education, and energy efficiency services. Responsible for low income energy issues management and regulatory relations.

Manager, Ops/Industrial Collections, oversees and directs the activities of business and financial analysts who are responsible for the support of the collections process. Responsible for collections strategy development support and implementation, including performance management, change management, system enhancements, and collections policies and procedures.

Senior Collection Service Associate, Low Income Customer Assistance NY, performs and accepts incoming and outgoing-related calls, resolves disputes and negotiates payment terms in an assertive and professional fashion, provides financial direction for customer and/or makes appropriate referral, processes customer-related transactions, documents and communications and interfaces with third parties.

Senior Analyst, Billing and Systems (this includes Principal Analyst), analyze, recommend, and implement solutions to customer billing, finance, and service issues. These issues can be corrective in nature, or offer significant improvement in efficiency and/or accuracy. Provide research and analytical support of customer information to the business units in support of their departmental and corporate goals. Assure proper operations of all customer-related systems and supplier services functions. Plan and direct activities of other analysts in support of large projects.

Supervisor Auxiliary Operations, manage the Company's interest and responsibilities related to Retail Choice of competitive services and energy. Direct a staff responsible for the accurate processing of competitive service enrollments, drops, changes, etc. to ensure assignment and handling of customers and their consumption with the appropriate supplier.

Supervisor New Requests/Operational Compliance, manage the analysis, design and development of all business requirements that involve the operation of the company's CSS system and for developing and managing Information Resources and Operational Compliance activities which support end to end CSS processes.

Supervisor Supplier Services, responsible for managing the Company's interest and responsibilities related to Retail Access and energy services companies. Direct a staff responsible for the accurate processing of ESCo enrollments and drops to ensure assignment of customers and their consumption to the appropriate supplier (ESCO or NG), necessary for correct ISO billing of both NG and ESCo's.

CUSTOMER SATISFACTION AND STRATEGIC PLANNING AND SUPPORT

(this function reports to the Customer Service SVPs of both New England and New York)

Analyst, Communications & Change Management (this includes Senior and Principal Analyst), responsibilities include: customer communications and change related issues for both NY and NE Customer Service, improving performance of our Customer Service through quality monitoring, employee development (training), root cause analysis, process enhancements and effective communications.

Analyst, Customer Relationship Management (this includes Senior and Principal Analyst), respond to and analyze incoming PSC complaints at QRS and SRS level, attend regulatory hearings and meetings as required to resolve disputes. Supervise rostered employees in handling of inbound telephone and written complaints. Perform reporting and documentation tasks as required.

Analyst, Customer Satisfaction & Strategic Planning (this includes Senior and Principal Analyst), work with the director of the group in completion of annual survey work, analytical projects of cost and service enhancements. Implement not only previously identified integration opportunities but to identify and implement new opportunities as well.

Collection Service Associate, Customer Relationship Management, performs and accepts incoming and outgoing-related calls, resolves disputes and negotiates payment terms in an assertive and professional fashion, provides financial direction for customer and/or makes appropriate referral, processes customer-related transactions, documents and communications and interfaces with third parties.

Customer Representative, Customer Relationship Management, reviews and processes all types of incoming and outgoing data, communicates with customers or their representatives and explains and/or initiates applicable procedures relative to billing, collection, deposit and service policies in conformance with Company regulations, guides and practices and performs all required clerical functions in accordance with prescribed procedures within the department.

Manager Communications & Change Management, lead employees whose responsibilities include: customer communications and change related issues for both NY and NE Customer Service, improving the performance of Customer Service through quality monitoring, employee development (training), root cause analysis, process enhancements and effective communications.

Manager Customer Relationship Management, interface with PSC regarding customer issues and identify policy issues to be addressed as needed. Survey customers and conduct analysis to monitor overall customer satisfaction of company performance. Perform root cause analysis and recommend corrective actions.

Manager Customer Satisfaction and Strategic Planning, directs, plans and organizes the work activities of the E-business, Customer Communication & Change Management and Customer Relationship management functions in Customer Service. Directs project management team's activities in support of Customer Service organization to insure timely and effective implementation of assigned initiatives. Performs projects assigned by SVPs of Customer Service as assigned.

Principal Financial Analyst, assist in the development and implementation of Customer Service projects or initiatives. Responsibilities include the documentation of project and identification of any reporting requirements related to the projects assigned. Take lead role in certain assigned projects; will also prepare various Customer Service monthly performance tracking measurements including any required by regulators.

Project Manager, lead in the development and implementation of Customer Service projects or initiatives. Responsibilities include the documentation of project and identification of any reporting requirements related to the projects assigned. Project Manager will also prepare and direct the preparation of various Customer Service monthly performance tracking measurements including any required by regulators.

NEW YORK DISTRIBUTION FINANCE

Analyst, Electric Pricing (this includes Senior and Principal Analyst), under the general direction of the Manager or Supervisor, Electric Pricing, or Supervisor, Tariff and Regulatory Administration lead a broad range of analyses and support related to the development and implementation of new pricing services, the development and support of regulatory strategy, and the administration and implementation of existing electric tariffs.

Analyst, Energy Supply (this includes Senior and Principal Analyst), perform all power purchase contract administration tasks. Perform analysis associated with contract modifications and customer savings; manage divestiture contracts and NY Power Authority contracts.

Analyst, Gas Transportation Services (this includes Principal Analyst), schedules and coordinates Niagara Mohawk's transportation of customer or Marketer owned gas.

Director, Gas Supply & Transportation, ensure that the necessary gas planning effort is done to determine the requirements of our customers and how those requirements can be met either through supply, customer transportation or demand resources. Develop and execute strategies to implement the plans. Direct or develop, negotiate and execute contracts for the procurement of gas supplies, hedging of price risks, pipeline capacity (including new interconnections), storage and peaking services.

Financial Analyst, Financial Performance Management (this includes Senior Financial Analyst), responsible for the preparation and coordination of budget (expense, capital and other) in support of the New York Distribution Business Plan. Participates in the Resource Allocation process through the direction of the Divisional Resource Allocation Committee (DRAC). Defines resource drivers and monitors/evaluates budget/actual variances, prepares assessment reports, recommends corrective actions. On a regular basis counsels and advises New York Distribution management in the interpretation and use of available accounting/budget data.

Manager Electric Pricing, directs, plans and organizes the evaluation, development and administration of electric pricing policies to serve the retail customers of Distribution – NY to achieve corporate objectives for sales profitability and customer value. Develops and manages overall pricing programs for all retail electric customers. Monitors and evaluates evolving competitive rate and marketing challenges resulting from industry restructuring and other changes in market conditions.

Manager Energy Supply, responsible for the work activities of personnel engaged in minimizing the total wholesale energy supply portfolio costs. Directs, plans, and organizes the activities related to purchasing installed capacity, purchasing energy requirements from the day ahead markets, and scheduling existing wholesale portfolio resources in the day ahead market. Directs the activities related to the implementation of power contracts including negotiation and administration of PURPA requirements. Manages the risk analysis for the wholesale portfolio. Directs the work activities associated with the power purchase payments associated with all Power Purchase arrangements and NYISO purchases.

Manager Financial Performance Management, leads and coordinates financial performance activities, directing all facets of financial performance management and the resource allocation process through the use and implementation of performance management techniques, processes and tools. Provides support for the New York Distribution's budget and business planning process/preparation and coordinate the flow of information to Corporate Finance including but not limited to cost variance analysis.

Manager Gas Pricing, directs a wide range of cost of service, revenue allocation, rate design and competitive assessment activities in support of the company's pricing programs. Monitors and evaluates the evolving, competitive market of the natural gas supply and delivery industry through; regular interaction with other utility and related industry professionals, large and commercial and industrial customers and state and federal regulators.

Manager Gas Supply Operations, manage the overall gas supply operations strategy to secure a least cost reliable gas supply for the Company as well as providing commercial and industrial gas customers with beneficial gas supply and storage services.

Manager Gas Transportation Services, manage and oversee Niagara Mohawk's transportation of customer or Marketer owned gas in accordance with contract or tariff requirements.

Manager Planning & Financial Analysis, manages, directs and coordinates financial analysis activities including identification, formulation and analysis of financial strategies or proposals. Initiates and manages the financial analysis of various projects, proposals and studies. Provides guidance, real-time training and technical assistance to other departments in the area of financial analysis.

NEW YORK DISTRIBUTION FINANCE

Principal Gas Supply Planner, develops models and analyses to forecast Niagara Mohawk's system and firm load requirements on a daily, seasonal and annual basis. Use these forecasts and analysis to assist in decisions on gas supply purchases and availability of NM transportation capability

Project Manager Regulatory, liaison between the Company and in-house DPS Auditors for requests that are of a financial nature. Provide Company personnel with advice/guidance in responding to regulatory requests. Assists in developing regulatory strategies. Performs financial analysis to support regulatory efforts.

Senior Analyst, Gas Pricing (this includes Principal Analyst), accountable for establishing and maintaining Company policies and developing innovative rates and services necessary to meet the needs of our customers and the Company. Performs, coordinates, and supervises other analysts in work related to rate design, gas revenue allocation, cost of service studies, revenue reporting, revenue forecasting, actual and forecasted gross margin by class, setting of market based rates, and calculation of fuel related billing adjustments.

Senior Analyst, Gas Supply Operations, negotiate the spot and longer term purchase of gas commodity and movement of that commodity on the interstate pipeline network to the city gate for NM's commodity customers. Implement Gas Supply hedging program.

Senior Analyst, Pricing & Regulatory Proceedings, under the general direction of the Manager or Supervisor, Electric Pricing, or Supervisor, Tariff and Regulatory Administration lead a broad range of analyses and support related to the development and implementation of new pricing services, the development and support of regulatory strategy, and the administration and implementation of existing electric tariffs.

Senior Financial Analyst, Planning & Financial Analysis (this includes Principal Financial Analyst and Principal Analyst) leads and coordinates financial analysis activities including identification, formulation and analysis of financial strategies or proposals. Leads and supports financial analysis of various projects, proposals and studies. Provides guidance, real-time training and technical assistance to other departments in the area of financial analysis.

Supervisor Electric Pricing, under the general direction of the Manager, Electric Pricing, plans and organizes the evaluation, development and administration of electric pricing policies to serve the retail customers of Distribution – NY to achieve corporate objectives for sales profitability and customer value. Develops and manages overall pricing programs for all retail electric customers. Monitors and evaluates evolving competitive rate and marketing challenges resulting from industry restructuring and other changes in market conditions

VP Energy Supply, Pricing & Regulatory Proceedings, responsible for energy supply and for retail pricing activities in support of the New York Distribution business; oversee selected regulatory proceedings related to supply, pricing and market structure issues. Energy supply matters are directed to the President of Niagara Mohawk Power Company and all other matters are directed to the SVP Distribution Finance New York.

INFORMATION TECHNOLOGY

Director IT Applications Development, responsible for the development of all major application systems (e.g., new Customer, GIS, CPAS, Computer-Aided Dispatch); is also responsible for the maintenance and enhancement of all IT supported systems.

Director IT Infrastructure, responsibilities include directing the design, development, deployment, enhancement and maintenance of mainframe, midrange and server based information systems, Wide Area (WAN) and Local Area (LAN) communications networks and Client Support services.

Director IT Strategy and Planning, responsible for the activities of the Architecture and Planning, Finance (Budgeting and Contracts Management), Cyber Security and Disaster Recovery functions within the It Department. Engage all functions of IT to plan for technology across all computing platforms (Mainframe, Midrange, Network and Desktop).

Manager Project Management Office, responsible for the overall direction of the project management office providing the following services: project management guidelines and standards, project life cycle methodologies and tools, departmental tools for work and resource management and centralized services for reporting.

INFORMATION TECHNOLOGY INFRASTRUCTURE

Data Center, EDP Console Operator, under general supervision to operate connected units of the computer from the computer console; to make prescribed operating connections, to maintain a computer log of operations for machine performance and production reports and to perform related functions.

Director Data Center Services, manages the design, budgeting, implementation, and on-going support for corporate mainframe and midrange platforms, IT system software portfolio, Data Center facilities, Enterprise Support Center services and processes, and Data Center operations.

EDP Console Operator A-T, Data Center, under general supervision to operate connected units of the computer from the computer console, to make prescribed operating corrections, to maintain a computer log of operations for machine performance and production reports and to perform related functions.

EDP Equipment Operator, Data Center, under direct supervision to operate various units of EDP auxiliary equipment such as card reader, printer and tape station from computer console; to verify accuracy and registration of printed forms, maintain computer log for machine performance and productions reports.

Manager Data Center Operations, manage operations and system performance on all platforms on a 7x24 basis. Manage data center facilities and critical subsystems, budget and execute maintenance services for mainframe, midrange platforms, and mainframe printing environment. Design and implement batch processing control systems, systems management platforms, and online report viewing services. Develop/design workflow and management processes for effective operations of mainframe and distributed environments.

INFORMATION TECHNOLOGY APPLICATION DEVELOPMENT

Application Developer, responsible for the fundamental project planning, and analysis and design/technical translation of business requirements into programs.

Computer Application Programmer, under general direction to maintain technical skills and be knowledgeable in current computer technology, develop and document accurate programming logic from functional specifications or logic diagrams, test and maintain the most complex computer programs in accordance with current system standards and procedures.

Designer C, prepare studies, analyses and reports relating to new projects and the protection, operation and maintenance of existing projects, performing engineering calculations as required; make engineering calculations as required to check adequacy of design.

Director Customer Applications, manages, directs, and controls activities related to automation opportunity identification, acquisition, development and implementation, from project approval through system optimization, including priorities and schedules. Directs the selection of the best technology to meet automation objectives and business needs.

Director Distribution Applications, ensures that all resources are obtained, and budgets and schedules are effectively controlled. Leads the Resource Management process: assigns work to managers, staffs teams with personnel who possess appropriate skill sets and ensures adequate training is provided. Reviews availability and demand forecast. Anticipates resource needs and projected availability.

Manager Asset Management, responsible for the overall planning, delivery and administration of asset management application systems, including the design, development, implementation, enhancement and maintenance of these systems within the defined IT standards of the corporation.

Manager Business Services NY, responsible for the overall planning and delivery and administration of business service application systems, including the design, development, implementation, enhancement and maintenance of these systems within the defined IT standards of the corporation.

Manager Customer Information Systems, responsible for the overall planning and delivery and administration of business service application systems, including the design, development, implementation, enhancement and maintenance of these systems within the defined IT standards of the corporation.

Manager IT Field Force Automation Support, responsible for the overall planning, delivery and administration of Field Force Application system, including the design, development, implementation, coordination and collaboration with the FFA vendor.

T&D TECHNICAL SERVICES

Chief Engineer, act as consultant for transmission system planning. Oversee the maintenance of uniform technical policies across the company. Provide technical development for technical managers and staff. Review new technologies for use in transmission and distribution. Oversee company research and development efforts.

Director Technical Training, responsible for the development and implementation of effective training programs for electric, gas and meter operations – both technical and non-technical where appropriate. Responsible for providing leadership for short and long term technical employee development strategies.

Director Meter and Data Services, direct the Meter Data Service Department in the collection, editing, management, analysis, aggregation and reporting of detailed electrical usage data. This includes estimation of hourly loads used in both the New York and New England ISO settlement processes.

Director Process and Systems, responsible for full integration of information systems into daily operations while maximizing the benefits of technology. Responsible for the development and implementation of a single suite of Operations information systems. Responsible for ensuring that existing initiatives are brought to a successful conclusion or brought in line with the plans for a single suite of systems.

VP Engineering Services, responsible for the efficient and effective engineering, design, analysis and other technical support provided to the operating companies of National Grid USA. This includes the diverse areas of substation, relay, transmission, meter and telecommunication engineering, design and standards; distribution standards and work-methods development; laboratory testing, qualification and operational support, asset management procedure and system analysis.

VP Environmental, responsible at National Grid USA for providing guidance to and oversight of the environmental compliance activities of the T&D operations and overall management of the Site Investigation and Remediation Program within National Grid USA.

VP Facilities Asset Management, plans, directs staffs, organizes, coordinates, develops programs, policies and procedures and provides overall leadership to the Facilities Asset Management Department.

VP Fleet Management, responsible for the asset management of the company's fleet of vehicles, equipment and aircraft. Responsible for the maintenance, acquisition and disposal of these assets.

VP Supply Chain, is responsible for Procurement, inventory management and accounts payable for all materials and services needed to support the operation of National Grid USA's companies.

T&D TECHNICAL SERVICES ENGINEERING SERVICES

Chief Meter Mechanic A, Rubber Goods NY, to work with and direct employees engaged in shop testing of watt-hour meters or protective equipment.

Chief Tester & Installer, Chemical Lab NY, to work with and direct a group of testers of any grade, except Test Specialist B.

Chief Tester & Installer, Engineering Lab NY, to work with and direct a group of testers of any grade, except Test Specialist B.

Chief Tester & Installer, Meter Testing NY, to work with and direct a group of testers of any grade, except Test Specialist B.

Designer, Overhead Engineering & Operations, develops the designs for components of construction, electrical and mechanical projects, prepares and maintains related diagrams, maps, and records, in addition to drafting work as required.

Designer, Underground Engineering & Operations, develops the designs for components of construction, electrical and mechanical projects, prepares and maintains related diagrams, maps, and records, in addition to drafting work as required.

Designer, Substation Design, develops the designs for components of construction, electrical and mechanical projects, prepares and maintains related diagrams, maps, and records, in addition to drafting work as required.

Designer, Transmission Line Engineering, create and maintain transmission line drawings, diagrams, maps, databases, and records using CADD software.

Designer B, Gas Engineering, under general supervision in the Engineering Department to do designing of minor and major construction projects of all types, to prepare specifications and estimates and to prepare and maintain related diagrams, maps and records, doing drafting work as required.

Designer C, Gas Engineering, under general supervision in the Engineering Department to develop complete designs for construction projects of all types, to prepare studies, reports, specifications and estimates, to direct and check the work of Drafting Technicians, Designers and Junior Engineers, of lower grade, to do drafting work as required.

Director Energy Delivery Services, responsible for the planning, developing, and coordinating of the implementation of policies, procedures and techniques for electric transmission and distribution construction, operation and maintenance on a system-wide basis.

Director, Lab and Testing Services, directs and has overall responsibility for activities performed by the engineering, dielectric, meter test and chemical labs for National Grid Service Company.

Director Project Management Services, oversees the capital projects portfolio including permitting and licensing, project management, scheduling and engineering consulting services for both New England and New York.

Director Substation Engineering Services, accountable for the effective planning, organizing, staffing, controlling, and directing of group labor, time and cost resources for the electrical design and drafting, and procurement of equipment relating to the electrical engineering of High Voltage and Extra High Voltage electric sub-station construction projects

Drafting Technician, Substation Design, prepare finished tracings and diagrams for construction projects. Record on standard maps the location of overhead electric distribution facilities.

Engineer, Gas Engineering (this includes Senior Engineer), responsible for the design of gas regulator stations, instrumentation, control, gate stations, transmission pipelines, mains, services and meters in accordance with all applicable codes and standards. In addition to evaluate the system for adequate capacity by performing load study analysis and evaluate the adequacy of the composition and heat content of the gas. Oversee the work performed by designers.

T&D TECHNICAL SERVICES ENGINEERING SERVICES

Engineer, Substation Engineering & Design (this includes Associate, Senior and Lead Senior Engineer), plan and design electrical substation facilities on a conceptual basis complying with environment, safety and National Grid standards and policies.

Engineer, Telecommunications Engineering (this includes Associate, Senior and Lead Senior Engineer), determine and develop methods to retrieve, share and use information from substation devices based on knowledge of corporate information goals and current technologies of LANs and protocols. Provide technical guidance to operating functions within National Grid on substation networks, network devices, their communications and diagnostics.

Engineer, Transmission Line Engineering (this includes Associate, Senior, Principal and Consulting Engineer), perform all aspects of transmission line project management and engineering, including design, estimating, licensing, scheduling, material acquisition, construction inspection, and oversight of engineering and environmental consultants.

Laboratory Tech A, Chemical Lab NY, to perform physical or electrical inspections, tests or investigations on materials or equipment including those involving complicated laboratory apparatus or procedures and to submit data on results.

Laboratory Tech A, Engineering Lab NY, to perform physical or electrical inspections, test or investigations on materials or equipment including those involving complicated laboratory apparatus or procedures and to submit data on results.

Laboratory Tech B, Chemical Lab NY, to maintain or assist in maintaining the most complicated laboratory apparatus, to make physical and chemical inspections, tests and investigations on materials and equipment involving laboratory apparatus or procedure.

Laboratory Tech B, Engineering Lab NY, to compare, calibrate and maintain primary electrical standardizing apparatus.

Manager Design, direct the implementation of effective, timely and efficient substation design through the management of the Substation Design Engineers and consultation with the Delivery Engineering and Protection, Telecommunications and Meter Engineering Departments. Review and provide engineering advice on capital T&D and non-utility generation projects.

Manager Engineering & Design, responsible for the effective and efficient design of substations in the Company's New York service area; this includes new facilities and the addition to, or revision of, existing facilities. This position is responsible for ensuring that all designs are in compliance with the NESC and Company standards. Working in coordination with the Manager, Engineering & Design New England responsible for the development of Substation design and construction standards.

Manager Engineering Lab, directs and manages the engineering standards and dielectric testing labs, and, in New York, the chemical lab.

Manager Gas Engineering, responsible for the safe and economic design of the gas infrastructure in accordance with all codes and standards. Oversee the work of gas designers and engineers engaged in the detailed design and analysis of all gas system components.

Manager Meter Test, directs and manages the electric meter labs for National Grid Service Company.

Manager Overhead Engineering & Operations, manages the development, distribution and implementation of company standard designs and specifications for materials and equipment and construction standards for the overhead distribution system.

Manager Protection & Meter Engineering, accountable for formulating policy, approving design and evaluating the operation of the Electric Protection Systems, including the coordination with adjacent utilities on all transmission interconnections, for the National Grid transmission, distribution, and non-nuclear generating facilities. Manage the System Protection Engineering Unit.

T&D TECHNICAL SERVICES ENGINEERING SERVICES

Manager Telecommunications Engineering, direct the implementation of system telecommunication design through the management of the Telecommunication Engineering Dept. and in consultation with the Protection Dept., the Substation Engineering Dept., Substation Design Dept., the Transmission Planning Dept., the Electric Distribution Planning Engineering Dept. and the Relay and Telecommunications Operations Departments, and the Telecommunication Services Dept in IT.

Manager Transmission Line Engineering, optimize the reliability performance of the overhead transmission system by developing and implementing project-specific engineering solutions, developing and managing work plans, and administering the transmission capital budget.

Manager Underground Engineering & Operations, manages the development, distribution and implementation of company standard designs and specifications for materials and equipment and construction standards for the underground transmission and distribution system.

Meter Mechanic, Meter Testing NY, to ascertain and utilize proper test connections and procedures. To test and maintain the most complicated billing metering equipment.

Meter Shop Tester, Meter Testing NY, to test and maintain watt-hours meters, demand registers and instruments transformers.

Meter Shop Tester C, Rubber Goods NY, to test and maintain watt-hours meters, demand registers and instrument transformers. To calculate and verify dial and billing constraints on watt-hours demand and multisator meters.

Senior Designer, Substation Engineering & Design, working under minimal supervision, is responsible for supporting the project engineer by providing required design and drafting inputs, including the development of primary electrical designs required for substation projects. In addition, drawing and design services will be provided to other functions, as required. Maintenance and control drawing files, along with ensuring the effective utilization and maintenance of the CADD system, is required.

Supervisor Chemical Lab, directs and supervises activities performed by the chemical lab in New York.

Supervisor Gas Engineering, responsible for the safe and economic design of the gas infrastructure in accordance with all codes and standards. Oversee the work of gas designers and engineers engaged in the detailed design and analysis of all gas system components.

Supervisor Meter Test, manage and control the inventory of electric revenue metering equipment and devises in the central test facility and at field locations.

T&D TECHNICAL SERVICES TECHNICAL TRAINING

Manager Electric Training, responsible for overhead, underground, substation and other electric disciplines training needs. Interfaces with groups in various disciplines supported and develops training to meet both their technical and other progression training needs.

Manager Gas & Meter Training, responsible for Gas, Meter and Distribution Design/Planning training. NY Fire School in Oswego, NY reports into this position. Interfaces with groups in the various disciplines supported and develops training to meet both their technical and other progression training needs.

Senior Training Representative, Gas & Meter Training, analyzes, researches, designs, develops and conducts advanced training programs to provide employees with knowledge and skills necessary to perform their jobs in a safe, cost efficient manner.

Supervisor Fire Training, responsible for training conducted at the Fire School. Interfaces with customers of the Fire School and develops training suited to meet their needs as it relates to fire safety; oversees the Fire Training School facility.

Training Representative, Electric Training (this includes Senior Training Representative), analyzes, researches, designs, develops and conducts advanced training programs to provide employees with knowledge and skills necessary to perform their jobs in a safe, cost efficient manner.

Training Representative, Fire Training, analyzes, researches, designs, develops and conducts advanced training programs to provide employees with knowledge and skills necessary to perform their jobs relative to fire safety.

T&D TECHNICAL SERVICES ENVIRONMENTAL

Analyst, Environmental Affairs NY (this includes Associate and Senior Analyst), supports the environmental compliance activities of the regulated T&D companies and unregulated subsidiaries.

Lead Senior Engineer, Environmental Affairs NY (this includes Principal and Senior Environmental Engineer), supports the environmental compliance activities of the regulated T&D companies and unregulated subsidiaries.

Lead Senior Engineer, Site Investigation & Remediation (this includes Senior Environmental Engineer), provides project management of hazardous waste site assessment and remediation.

Manager Environmental Affairs NE, develops and advocates to internal and external constituents the company's position on all environmental regulatory issues. Performs environmental impact assessments and evaluations including the analysis and interpretation of environmental laws and regulations to determine the implication on company facilities providing guidance and support to all NE and NY departments on environmental requirements ensuring compliance issues are properly addressed.

Manager NE & NY Site Investigation & Remediation, directs all activities associated with the multi-year hazardous waste site investigation and remediation program including the management of all appropriate regulatory, governmental, and agency relationships associated with this effort and all project management activities associated with the integration of scientific assessment, engineering and design, construction management, and project controls to meet federal and state regulatory requirements and budget/schedule targets.

Manager NY Compliance, develops and advocates to internal and external constituents the company's position on all environmental regulatory issues. Performs environmental impact assessments and evaluations including the analysis and interpretation of environmental laws and regulations to determine the implication on company facilities providing guidance and support to all NE and NY departments on environmental requirements ensuring compliance issues are properly addressed.

Principal Environmental Engineer, Licensing and Permitting, plans, schedules and manages environmental licensing and permitting of projects including cost control, evaluation of environmental regulations and preparation of licenses/permits positions and documents.

Senior Analyst, Licensing and Permitting, plans, schedules and manages environmental licensing and permitting of projects including cost control, evaluation of environmental regulations and preparation of licenses/permits positions and documents.

Senior and Principal Analyst, Site Investigation & Remediation, provides project management of hazardous waste site assessment and remediation.

Lead Senior, Environmental Affairs NE (this includes Senior Environmental Engineer and Senior Environmental Engineer Field), supports the environmental compliance activities of the regulated T&D companies and unregulated subsidiaries.

T&D TECHNICAL SERVICES PROCESS AND SYSTEMS

Blueprint & Photostat Operator, under direct supervision to operate duplicating equipment to produce micro-film, photostat, blue line negative print, blueprint, black and white copies of engineering and other records.

Director, Process and Systems, responsible for full integration of information systems into daily operations while maximizing the benefits of technology. Responsible for the development and implementation of a single suite of Operations information systems. Responsible for ensuring that existing initiatives are brought to a successful conclusion or brought in line with the plans for a single suite of systems.

Drafting Technician, under direct supervision to do good tracing and complex detailing involving no original design of plans and drawings for construction projects of all types of diagrams, maps, and records.

Manager Systems Support, plans and directs activities associated with Business Information Resources including management of business aspects of projects/systems as well as planning and preparing schedules for system testing, implementation, production support and system maintenance.

Plant Inventory Recorder, under general supervision to coordinate the preparation and perpetuation of standard maps and records of all gas and electric facilities with physical plant and the continuing property record.

T&D TECHNICAL SERVICES FLEET MANAGEMENT

Manager Fleet Maintenance, responsible for the preventive maintenance and repair of vehicles and equipment; ensures that garages comply with all appropriate safety and environmental rules and regulations. Maintains and repairs vehicles so that they are safe, available and reliable.

Supervisor Fleet Maintenance, responsible for the direct supervision of the physical workers involved in the maintenance and repair of all company vehicles and equipment assigned to their particular garage.

T&D TECHNICAL SERVICES SUPPLY CHAIN MANAGEMENT

Analyst, Stores (this includes Associate, Senior and Principal Analyst), performs analysis in support of completion of procurement or inventory management activities.

Analyst, Procurement, organize, plan, develop, implement and support departmental projects concerned with new and improved procurement methods and/or cost reduction initiatives.

Director Inventory Management, directs, manages and plans the Electric and Gas Materials Management activities including physical inventory, shipping-delivery logistics, quality assurance, transactions processing, systems development and support, stock levels/reorder points and cataloging/standardization.

Director, Procurement, direct, manage and supervise the Purchasing department in the acquisition of materials, equipment, construction and service. Establish and coordinate levels of support to internal customers and ensure quality, timely and cooperative service.

Manager Procurement, coordinates, manages and directs the procurement of goods and services. Manages the sourcing process and develops and implements supply chain related e-business strategies.

Manager Warehouses, directs and coordinates the inventory at the central warehouses and satellite locations including materials requirement planning, forecasting, order management/expediting. Directs and coordinates the loading and delivery activities including distribution resource planning.

Purchasing Agent (this includes Associate, Senior and Principal Purchasing Agent), actively participate in project development, supporting project teams by guiding strategy development and promoting consistent contracting practices, including: contract packaging, bidder qualification, pricing, bid evaluation and award. Performs commercial tasks associated with completion of procurement events.

Storekeeper, responsible for the operation of the district warehouse facility and the delivery of crew orders to satellite and staging areas.

Supervisor Area, Stores, direct and coordinates the inventory at a central warehouse or satellite location including materials requirement planning, forecasting, order management/expediting. Directs and coordinates the loading and delivery activities including distribution resource planning

Supervisor T&D Storeroom, directs and coordinates resources that perform warehousing activities at central warehouse locations.

PROPERTY AND REAL ESTATE MANAGEMENT FACILITIES

Area Supervisor Facilities, NY, responsible for providing a safe and secure work environment for our employees in our office buildings, service centers and crew facilities and their associated grounds. Provide superintendent-level oversight for the divisional crew and office facilities including janitorial, mechanical and electrical equipment, buildings, grounds sidewalks and parking lots.

Chief Printing Specialist, NY Facilities Print Shop, under general supervision to be responsible for all printing work including contacts with internal customers and outside vendors to ensure that work is completed in a timely, accurate and cost competitive manner.

Director Facilities Asset Management, develops and implements asset management program for our facilities.

Director Facilities Operations, provide a safe and secure work environment for employees in our office buildings, service centers and crew facilities; manage, coordinate all maintenance, construction and repairs of the facilities and their equipment, including compliance with federal, state and local codes and statutes.

Manager Office Services (NE and NY), manages Office Service functions including Food Service, Copier Program, Receptionist, Reproduction, Record Keeping, Shipping & Receiving, Courier Services and Records Management.

Manager Operations Facility New England, provide a safe and secure work environment for employees in our office buildings, service centers and crew facilities; manage, coordinate all maintenance, construction and repairs of the facilities and their equipment, including compliance with federal, state and local codes and statutes.

Printing Specialist, NY Facilities Print Shop, under general supervision perform press and copy work of the highest degree of complexity in a proficient and efficient manner. Work includes operating and maintaining a variety of press/copy and bindery equipment, and making minor machinery adjustments, when required.

Supervisor Building Maintenance, MECO and NECo, responsible for providing a safe and secure work environment for our employees in our office buildings, service centers and crew facilities and their associated grounds. Provide supervisory level oversight for divisional crew and office facilities including all janitorial, mechanical and electrical equipment, buildings, grounds, sidewalks and parking lots.

Supervisor Building Maintenance, NY Facilities, responsible for providing a safe and secure work environment for our employees in our office buildings, service centers and crew facilities and their associated grounds. Provide supervisory level oversight for divisional crew and office facilities including all janitorial, mechanical and electrical equipment, buildings, grounds, sidewalks and parking lots.

Supervisor Facilities, MECO, develop and monitor implementation of internal maintenance programs and selects related services, equipment and material.

Supervisor, NY Facilities Archive/Records, implement and maintain a regulatory compliant records management program. Responsibilities include: research, development and implementation of regulatory correct records retention schedules, the collection, indexing and storage of company records.

Supervisor, NY Facilities Mail Room, supervises all mail, shipping operations of the system mail center, as well as oversee the regional mail operations throughout New York State service territory.

Supervisor, NY Facilities Print Shop, responsible for managing all activities associated with the NY Print Services Department. Major duties include supervision, forms database management/maintenance and invoice approvals/departmental charge-backs.

System Records Specialist, NY Facilities Archive/Records, act as the main consultant between System Records Management and our imaging clients. Imaging project development and implementation; including feasibility studies. Prepare imaging equipment specifications

BUSINESS DEVELOPMENT

Principal Financial Analyst, conducts financial and business analysis of existing businesses and other transactions or business opportunities which may from time-to-time come under consideration.

SVP Business Development, responsible for the identification, evaluation and, where appropriate, execution of new business opportunities for National Grid USA.

VP Transmission Development, responsible for the developing opportunities to expand National Grid Transco's business in North America, with a focus on transmission.

FINANCE

Associate Analyst, Claims, responsible for working with the database vendors and internal IT staff to design custom reports which will provide for enhanced drill down capabilities as well as interface with standard and company-specific databases; responsible for creating status and benchmarking reports for the Claims Manager, as well as the maintenance and control over the claims database system.

Claims Assistant, responsible for initiation of the claims procedure, the maintenance of active (open) files and the recording of the final disposition of the claim. Responsible for creating status and benchmarking reports for the Claims Manager., as well as the maintenance and control over the claims database system.

Claims Representative, investigates, analyzes and disposes of claims involving damage to customer property or personal injury by using established procedures and problem solving skills.

Director ERP Business Support, responsible for maintaining and support ERP business applications.

Manager Claims, responsible for development, implementation, and management of a centralized department for handling both first and third party claims. Responsible for quarterly reports to management containing case information and reserves. Has oversight responsibility for the management of claims litigation.

VP & Controller, has overall responsibility for general, plant and revenue accounting activities within the Company, as well as for external reporting done by the Company and all accounting policies employed by the company.

Vice President Real Estate Management and Property Tax, responsible for the Property Assets and Real Estate Department which facilitates the acquisition, disposition, and protection of real estate rights. Also responsible for the Property Tax Department which manages the expense of taxes paid on property owned by the various companies throughout the US.

VICE PRESIDENT AND CONTROLLER

Accounting Analyst, Revenue Accounting (this includes Senior and Principal Accounting Analyst), ensure accurate and timely billing. Implement procedural and accounting changes and revise as necessary.

Analyst, Accounting Services (this includes Senior Analyst and Senior Financial Analyst), preparation of financial statements and reports, including balance sheets, income statements, and cash flows for internal reporting, as well as reporting to the Federal Energy Regulatory Commission and state public utility commissions.

Director Accounting Services, overall responsibility for managing what had been formerly known as General Accounting and Plant Accounting (now a combined function). Responsibility for the monthly closing process, and coordination of efforts required to support regulatory and financial audits.

Manager Revenue Accounting, responsible for managing the miscellaneous billing function and payment processing and control function. Miscellaneous billing encompasses all non "electric use" billing, including transmission billing. Payment processing and control manages the lockbox and/or payment processing activities as well as reconciling and verifying all electric use billing,

Supervisor Distribution Companies, oversight of the general ledgers and fixed asset registers of our distribution subsidiaries. Controls the monthly closing process for those companies. Supports organizational questions regarding fixed asset or accounting questions

Supervisor Payments and Controls NY, Revenue Accounting, responsible for providing reconciliations and balancing of the CSS billings: oversight of the payment processing group; and providing the monthly unbilled revenue calculation.

REAL ESTATE MANAGEMENT AND PROPERTY TAX

Analyst, Property Tax, assists in the analysis and evaluation of property tax issues, and in the preparation, verification and processing of all materials involving Company property tax assessments and the associated taxes. Works to settle assessment and valuation disputes with appropriate officials. Applies for exemptions, refunds, corrected assessments and any other relevant means of reducing property tax.

Designer, Reg Disposition NY, under general supervision in the Engineering Department to develop complete designs for construction projects of all types, to prepare studies, reports, specifications and estimates; to direct and check the work of drafting technicians, designers and junior engineers, prepare or direct the preparation of general layout drawings for all types of construction projects, prepare studies, analyses and reports relating to new projects and the protection, operation and maintenance of existing projects, performing engineering calculations as required

Director Property Tax, develops and oversees the implementation of tactics and strategies to minimize the Company's property tax expense and administrative costs related to property tax. Originates and pursues property tax savings opportunities through informal assessment reviews, formal appeals and litigation, economic and functional obsolescence factors, and other methodologies.

Drafting Technician B, Reg Disposition NY, under direct supervision to do satisfactory tracing, lettering and elementary detailing involving no original design of plans and drawings for construction projects of all types and of diagrams, maps and records.

Instrument Operator, Reg Disposition NY, under direct supervision in the Engineering Department to perform the work of an instrument operator in a Survey Party making land and property surveys and surveys for construction projects of all types.

Manager Distribution Rights NY, manages and directs the acquisition of legal rights by department agents for the placement, access and maintenance of all types of electric utility activities and facilities for the retail distribution company's. Responsible for the proper preparation of documents, recording of legal instruments and maintenance of records and associated filing system.

Real Estate Representative (this includes Senior Real Estate Representative), maximize and protect the value of the Company's real estate. Acquire land and land rights associated with fee, easements, leases licenses and permits. Provide support in the siting of facilities and maintaining environmental compliance.

Right of Way Agent, under general supervision to secure land, rights of way and other rights necessary for the construction and maintenance of all types of overhead and underground lines and structures and to settle some small claims against the Company resulting from construction activities.

Senior Analyst, Property Tax, performs analysis and evaluation of property tax issues. Prepares, verifies, and processes materials involving Company property tax assessments and the associated taxes. Negotiates assessment and valuation disputes with appropriate officials. Identifies, researches and applies for exemptions, refunds, corrected assessments and any other relevant means of reducing property tax.

Supervisor Real Estate Rights (West, Central/Corporate and East), directs strategic deployment of negotiations with respect to real estate, both internally and externally, to maximize asset value. The Supervisor manages job acceptance, assignment, and execution within the Delegation of Authority and the approval processes.

Supervisor Survey, supervise, plan and direct surveying and mapping activities in support of real estate transactions, field operations and engineering.

HUMAN RESOURCES

Director Labor NY, supervises activities related to the negotiation, interpretation and administration of collective bargaining agreements. Administers dispute resolution procedures and certain HR policies and procedures associated with union employees.

Human Resources Consultant (this includes Senior HR Consultant), actively participates and collaborates with senior management of the business group represented to develop human resources strategies and business plans designed to support the business group's needs and objectives. Assesses HR implications of various business strategies

Manager Labor Relations NY, responsible for partnering with assigned business organizations to coordinate the administration of the collective bargaining agreement and administer the dispute resolution procedures, job performance management systems and those HR policies and procedures affecting represented employees. Interacts with internal and external clients representing Company interests in matters involving represented employees.

Senior Human Resources Assistant, resolve or refer inquiries appropriately and follow up on action taken. Carries out administrative duties related to functions such as employment, employee records, HRIS, benefits, labor relations and payroll.

VP Human Resources Operations, has primary responsibility for all human resources operations. This includes total compensation administration, employee relations, HR information systems, record keeping and related operations, and payroll functions. Has executive responsibility for union contract negotiation and interpretation. Has administrative and record keeping responsibility for annual and long-term incentive plans.

VP & Director Human Resources Services, consults and collaborates with management of the organization to develop human resources strategies and business plans to meet their needs and objectives. Has overall responsibility for recruiting, employment, workforce planning, labor relations, organizational development and diversity activities.

LEGAL AND EXTERNAL RELATIONS

Corporate lawyers (Deputy General Counsel, Assoc General Counsel, Assistant General Counsel, Counsel, Associate Counsel and Senior Attorney) are responsible for providing legal advice and representation to all affiliates of National Grid USA on a broad range of legal issues in the corporate and commercial areas including but not limited to, negotiating and drafting legal agreements, contracts, and memoranda; handling the legal aspects of a full range of corporate and commercial transactions; corporate record keeping; employment and benefit law; merger and acquisitions; securities law; financings; and managing outside counsel in these areas.

Deputy General Counsel, (Ramsauer) head of corporate and commercial practice group of lawyers and staff.

Deputy General Counsel, (Robinson) responsible for state regulatory affairs.

Deputy General Counsel, (Sherman) responsible for commercial litigation, environmental law, personal injury and property damage claims and compliance.

Deputy General Counsel, Transmission Federal Affairs, (Flynn) responsible for federal regulatory affairs and legal support for Transmission organization.

General Counsel – NMPC, (Gerwatowski) chief legal counsel managing legal affairs affecting Niagara Mohawk in New York.

General Counsel Property, (Rabinowitz) responsible for property and real estate matters and transactions.

Litigation lawyers (Deputy General Counsel, Counsel, Associate Counsel, and Senior Attorney) provide legal advice and representation to all affiliates of National Grid USA on a broad range of legal issues associated with dispute resolution and compliance, responsibilities include commercial litigation, environmental law, personal injury and property damage claims and compliance.

Niagara Mohawk Power Company lawyers (General Counsel, Assistant General Counsel, Counsel and Associate Counsel) provide legal advice and representation to all affiliates of Niagara Mohawk Power Company on a broad range of legal issues associated with the National Grid USA's regulated and unregulated businesses in upstate New York.

Property lawyers (General Property Counsel, Counsel, Associate Counsel and Senior Attorney) provide legal advice and representation to all affiliates of National Grid USA on a broad range of legal issues associated with the use, management, acquisition and disposition of real estate, and interests in real estate including collaborating with and managing outside counsel; negotiating the resolution of legal disputes involving property rights; drafting legal memoranda, contracts and agreements; and handling environmental and other legal issues related to corporate real estate transactions.

Regulatory lawyers (Deputy General Counsel, General Counsel, Counsel and Associate Counsel) are responsible for providing legal advice and representation to all affiliates of National Grid USA on a broad range of legal issues arising out of the companies' interaction with state regulatory authorities.

Transmission and Federal Affairs lawyers (Deputy General Counsel, Assistant General Counsel, Senior Attorney, Associate Counsel and VP Federal Affairs) provide legal advice and representation to all affiliates of National Grid USA on a broad range of legal issues with a focus on regulatory affairs associated with the electric transmission business.

LEGAL AND EXTERNAL RELATIONS

Director Security, oversees the protection of the organization's employees, properties and all items of value on company premises from any preventable harm or danger. Develops policies and procedures that comply with federal guidelines and standards.

Graphic Artist, Marketing Communications, under general supervision to conceive and create a wide variety of art and printed materials; design printed materials and prepare such materials for printing; create and produce a variety of art work using various production methods and equipment.

Manager Marketing Communications, plan and execute the company's program for communicating with customers. Advise senior managers on the best marketing tools to achieve specific business objectives. Direct the creation and production of bill inserts, literature and advertising.

Manager Public Relations, manage the development of key messages on a variety of issues and ensure consistent delivery of those of messages to appropriate internal and external audiences. Provide media training to appropriate company executives and operations managers.

Manager Security (Central, West and East), manages System Security investigators and guard force to protect Company assets and to recover Company assets that are lost or stolen. Manages the development of programs and strategies designed to protect and recover Company assets.

Photographer, Marketing Communications, under general supervision to do photographic work in the field or studio; operate dark room equipment, develop film, make prints, enlargements, slides, etc; mix chemicals and prepare stock solutions, maintain file and index of negatives.

Plant Guard, under general supervision to make periodic inspection tours of buildings, structures and grounds and register at regular watch stations along the route of inspection as evidence of having made inspections at specified times; to observe and report unusual conditions and irregularities so as to minimize the possibility of fire, theft, illegal entry or trespass, injury to personnel, storm damage to materials and equipment, etc.

Principal Communications Representative, Public Relations, assists in the planning, research, writing, proofreading and project coordination of customer newsletters, bill inserts, brochures, envelope and bill messages, customer letters and voice scripts, advertising and web-based communications.

VP and Director Corporate Communications, serve as chief spokesperson for corporate matters in the US. Develop strategic communications plan and budget to include media relations, employee communications, customer communications, corporate advertising, community relations, and marketing communications.

VP and Director Corporate Security, responsible for all aspects of security for National Grid USA including management of contract security, threat management and serving as a liaison with state and federal law enforcement agencies.

GRIDAMERICA

Asset Strategy & Best Practice Manager, responsible for managing the Asset Strategy team in developing the reputation of GridAmerica's Independent Transmission Company (ITC) model for cost-effective delivery, delivering asset management consultancy services to the Midwest Independent System Operator (MISO) and its member companies, and investigating and sharing newly identified better practices.

Asset Strategy Consultant, responsible for developing the reputation of GridAmerica's Independent Transmission Company (ITC) model for cost-effective delivery, contributing to the development of operating/project plans for delivery of asset management consultancy services to Midwest Independent System Operator (MISO) and its member companies, and within GridAmerica, acting as the resident experts in the following areas: asset health reviews (including fault and defect reporting); post-commissioning equipment modifications; maintenance (including live working) - frequency and content; spares policies; rating enhancements (including real-time monitoring); and new technology.

Assistant Controller, responsible for performing and/or directing GridAmerica's accounting functions. These functions include establishing and maintaining accounting policies, practices and procedures. Also assists the VP of Finance in the preparation and evaluation of budgets and other financial operating reports.

Database Administrator, responsible for testing the settlement IT processes, maintaining and developing settlement and scheduling interfaces, and implementing disaster recovery strategy for IT systems.

Economic Strategy Engineer, responsible for the development of economic modeling tools, scenario development for economic forecasting, forecasting identification of operational strategies to manage congestion, and identification and management of economic risks

Human Resources Manager, responsible for managing employee relations, recruitment and retention, immigration issues, payroll, benefits, corporate communications, safety, and facilities.

Investment Planning Manager, responsible for the development of a Long Range Transmission Expansion Plan for the GridAmerica footprint that provides for reliable service and that provides for the operation of an efficient market

Network Administrator, responsible for building and administering networks, performing system backups on network servers, and designing and supporting server systems and supporting software.

Office Administrator, responsible for facilities and safety operations as well as working with the Network and Database Administrators in providing information technology hardware and software support to staff members.

Operational Planning Engineer, responsible for coordinating and optimizing transmission outage plans for the GridAmerica transmission systems in the most economic manner, in accordance with security and quality of supply standards as well as ensuring the plan will deliver the required access to the transmission equipment for maintenance and construction, whilst maximizing available flowgate capacity (AFC) values for transaction paths within the GridAmerica footprint from real time to one year ahead.

Operational Planning Manager, responsible for the quality processing of power schedules and ensuring all schedules are processed according to the North American Electric Reliability Council (NERC) rules, and is also responsible for the coordination and planning of a reliable transmission system whilst maintaining a high transmission availability and responsible for the calculation of available flowgate capacity (AFC) values and the analysis of monthly or longer transmission service requests utilizing these AFC values.

Operational Policy Engineer, responsible for managing the implementation of the Day-2 Market within GridAmerica and for modeling the incentivised transmission income.

Operational Policy Manager, responsible for implementation of the Midwest Independent System Operator (MISO) Day-2 Market, implementation and ongoing maintenance of the Settlements systems, control and management of system congestion, ongoing development of business processes, disaster recovery, and audit of operating practices.

President, responsible for all aspects of the business, including operations, finance, legal affairs, regulatory affairs, and business development

Regulatory Affairs Manager, responsible for monitoring, interpreting, and influencing the development of Regional Transmission Organization (RTO), state, and federal rules, regulations, and procedures to ensure they will support the continued development of Independent Transmission Companies (ITCs).

GRIDAMERICA

Scheduler, responsible for the scheduling of the energy transactions that source or sink within GridAmerica. This responsibility includes receiving schedules from North American Electric Reliability Council (NERC) E-Tags and the Midwest Independent System Operator (MISO) Electronic Scheduling system, verifying information on the tag, verifying the tag represents an appropriate use of the transmission service, and verifying that operating limits are not exceeded by the impact of the schedules.

Settlements Consultant, responsible for the development and agreement of operational procedures, leading contact on all aspects of transmission settlements process, and leading contact on transmission tariffs.

Transmission Planning Engineer, responsible for managing interactions and contracts between the generators, load-serving entities, transmission line owners, Midwest Independent System Operator (MISO), and internal and external parties involved with interconnecting facilities to the GridAmerica-controlled transmission systems. The role also involves performing technical analysis of proposed facility connections to ensure adequate thermal, short circuit, and stability criteria have been met for a reliable interconnection as well as identifying investment improvements to the transmission systems and identifying potential engineering solutions to increase reliability and transmission capacity.

Vice President - Commercial Affairs, responsible for forwarding the business and commercial interests of the Company in all aspects, including coordinating the regulatory and consulting aspects of the business and identifying and developing new and existing business opportunities available to GridAmerica.

Vice President – Operations, responsible for managing the operations unit, which has the primary objective to independently plan and develop the transmission systems of the member utilities of GridAmerica, under the plenary authority of the Midwest Independent System Operator (MISO) Regional Transmission Organization (RTO).